



HAL
open science

Magnetomètres Sol, capteurs SIEMEL (Licence ANVAR/CNRS), INPG station mobile ELF n°31 VLF n°32, TAAF Kerguelen ELF n°30 VLF n°34, Gal. BELGRANO VLF n°33

J.F. Karczewski, F.X. Sene

► **To cite this version:**

J.F. Karczewski, F.X. Sene. Magnetomètres Sol, capteurs SIEMEL (Licence ANVAR/CNRS), INPG station mobile ELF n°31 VLF n°32, TAAF Kerguelen ELF n°30 VLF n°34, Gal. BELGRANO VLF n°33. [Rapport de recherche] Note technique CRPE n° 23, Centre de recherches en physique de l'environnement terrestre et planétaire (CRPE). 1976, 64 p. hal-02191394

HAL Id: hal-02191394

<https://hal-lara.archives-ouvertes.fr/hal-02191394>

Submitted on 23 Jul 2019

HAL is a multi-disciplinary open access archive for the deposit and dissemination of scientific research documents, whether they are published or not. The documents may come from teaching and research institutions in France or abroad, or from public or private research centers.

L'archive ouverte pluridisciplinaire **HAL**, est destinée au dépôt et à la diffusion de documents scientifiques de niveau recherche, publiés ou non, émanant des établissements d'enseignement et de recherche français ou étrangers, des laboratoires publics ou privés.

RP

182 (10)

**CENTRE NATIONAL D'ETUDES
DES TELECOMMUNICATIONS**

**CENTRE NATIONAL DE LA
RECHERCHE SCIENTIFIQUE**

**CENTRE DE
RECHERCHES
EN PHYSIQUE DE
L'ENVIRONNEMENT
TERRESTRE
ET PLANETAIRE**

CRPE

**NOTE TECHNIQUE
CRPE / 23**



MAGNETOMETRES SOL
CAPTEURS SIEMEL (Licence ANVAR/CNRS)
INAG Station mobile ELF n° 31 VLF n° 32
TAAF Kerguelen ELF n° 30 VLF n° 34
Gal. BELGRANO VLF n° 33

par

J.F. KARCZEWSKI/F.X. SENE



18 JUN 1977

CENTRE DE RECHERCHE EN PHYSIQUE DE
L' ENVIRONNEMENT TERRRESTRE ET PLANETAIRE

NOTE TECHNIQUE CRPE/23

Magnetomètres Sol

Capteurs SIEMEL (Licence ANVAR / CNRS)

INAG Station mobile ELF n° 31 VLF n° 32

TAAF Kerguelen ELF n° 30 VLF n° 34

Gal. BELGRANO VLF n° 33

par

J.F. KARCZEWSKI et F.X. SENE

C.R.P.E./ P.C.E.

45045 ORLEANS CEDEX FRANCE



Septembre 1976

Le Directeur

J. HIEBLLOT

CHAPITRE 2.3.MOYENS D'OBSERVATIONS.

On utilise deux capteurs séparés pour couvrir la plage de fréquence 8 Hz - 15 kHz pour obtenir la meilleure sensibilité et aussi pour bénéficier au mieux des différentes possibilités de transmission des signaux par télémesure.

Le principe de deux capteurs est le même que celui des capteurs ELF - VLF des expériences GEOS [1] ou ARAS [2].

DESCRIPTION DU CAPTEUR.

Il s'agit essentiellement d'un noyau droit dont le diamètre, la longueur, le matériau, sont optimisés en fonction de la plage de fréquence et de la sensibilité demandée.

Un enroulement principal transforme le signal magnétique en tension électrique à travers sa propre impédance de type résonante. Un système à contre-réaction de flux constitué d'un amplificateur très faible bruit, très haute impédance attaquant un deuxième enroulement permet de rendre la bande plate avec une fonction de transfert en

$$\frac{K R_{CR}}{2 \pi M}$$

avec K pente du capteur en $V \cdot \gamma^{-1} \cdot H_z^{-1}$

R_{CR} résistance de contre-réaction

M inductance mutuelle entre les deux enroulements.

Les deux derniers étages font office de filtre pour avoir la bande passante définie ainsi que le niveau



ELF 10 Hz - 450 Hz - 10 V/γ

VLF 400 Hz - 15 kHz - 10V/γ

ainsi que d'amplificateur adaptateur pour la transmission par câble (environ 100 mètres) vers le système "Step Amp" placé auprès de la télémessure.

Le dossier technique joint en annexe donne toutes les caractéristiques magnétiques et électriques des deux capteurs ELF et VLF.

INSTALLATION.

Des mesures faites à GARCHY ont montré que l'impédance du sol n'est pas tout-à-fait négligeable à partir de quelques kHz et donc que le signal VLF reçu au sol est légèrement atténué. (un effet de l'ordre de 3 à 6 dB a été mesuré entre 0 et 6 mètres sur l'émetteur de St ASSISE 16,8 kHz).

Mais par ailleurs, il apparaît comme extrêmement souhaitable que les capteurs ne soient soumis à aucune vibration. En effet, dans le champ magnétique terrestre ($\sim 50\ 000\ \gamma$) un déplacement crête de 10^{-5} ° équivaut à un champ à la fréquence de vibration de 1 milligamma.

On devrait donc envisager une compensation du champ terrestre au niveau des capteurs avec un système ne risquant pas d'induire d'autre champ perturbateur (un simple aimant peut suffire).

Les câbles qui relient les préamplificateurs aux capteurs ainsi que les préamplificateurs à la télémessure doivent être maintenus parfaitement fixes. En effet, un câble qui vibre induit par friction électrostatique dans le diélectrique qui le compose des charges sur l'âme équivalentes à quelques μV . Les niveaux transmis sont de cet ordre.

Le câble de calibration peut véhiculer des parasites jusqu'au cœur du système. En effet, on utilise l'enroulement de

contre-réaction attaqué avec un additionneur résistif pour faire la calibration interne.

Il est très important de ne pas mettre sous tension les PA s'ils ne sont pas connectés à leur antenne respective.

CARACTERISTIQUES DES CAPTEURS.

L'ensemble a été développé sous la responsabilité du département PCE/CRPE. Les capteurs et P.A. ont été réalisés par la Société SIEMEL (titulaire de la licence ANVAR concernant ce type de capteur). Les calibrations et mesures ont été assurées par nos soins [3]. Elles sont données dans les courbes jointes.

Nous tenons à remercier Mrs MACHU et SPADI de l'ESA qui ont mis à notre disposition le blindage de grande dimension existant à l'ESTEC ainsi que le système d'analyse (Analyseur HP avec FFT) qui nous a permis de mesurer la sensibilité des capteurs.

REFERENCES.

- 1 Capteurs magnétiques ELF, VLF de l'expérience S.300 (satellite GEOS), note technique CRPE/11 - K. KODERA, J.F. KARCZEWSKI.
- 2 Description de l'expérience onde ARAKS, note technique LGE - janvier 1976.
- 3 Description de la station automatique de test magnétique CRPE de CHAMBON-LA-FORET - Note CRPE/21, mai 1976, B. DUBOYS, J.F. KARCZEWSKI, J.M. MOREAU, F.X. SENE.

LISTE DES FIGURES ET SCHEMAS

- 6 - Magnétomètre sol - Câblage du boîtier étanche LGE.
- 7 - " - Câble de liaison antenne.
- 8 - " - Câble de sortie - Calibration et alimentation
- 9 - " - Antennes ELF - VLF SIEMEL
- 10 - " - Préamplificateur ELF SIEMEL (schéma électrique)
- 11 - " - " (implantation)
- 12 - - Nomenclature ELF
- 13 - - Suite
- 14 - - Préamplificateur VLF SIEMEL (schéma électrique)
- 15 - - " (implantation)
- 16 - - Nomenclature VLF
- 17 - - Suite
- 18 - - Schéma du système de calibration utilisé à CHAMBON-LA-FOIE
- - Fonction de transfert : amplitude et phase en champ homogène externe ELF N° 30. (courbe N° 00109).
- 19 - - Listing ELF N° 30 CAL EXT.
- 20 - - Suite
- 21 - - Fonction de transfert : CAL EXT ELF N° 31 (courbe N° 00108).
- 22 - - Listing ELF N° 31 CAL EXT.
- 23 - - Suite
- 24 - - Fonction de transfert CAL EXT VLF N° 32 (courbe N° 00105)
- 25 - - Listing VLF N° 32 CAL EXT.
- 26 - - Suite
- 27 - - Fonction de transfert CAL EXT VLF N° 33 (courbe N° 00104).
- 28 - - Listing VLF N° 33 CAL EXT.
- 29 - - Suite
- 30 - - Fonction de transfert CAL EXT VLF N° 34 (courbe N° 00100).
- 31 - - Listing N° 34 CAL EXT.
- 32 - - Suite
- 33 - - Suite

- 34 - Schéma de principe de mesure des fonctions de transfert en CALIBRATION INTERNE.
- 35 - Fonction de transfert CAL INT ELF N° 30 (courbe N° 00110).
- 36 - Listing ELF N° 30 CAL INT.
- 37 - Suite
- 38 - Fonction de transfert CAL INT ELF N° 31 (courbe N° 00107).
- 39 - Listing ELF N° 31 CAL INT.
- 40 - Suite
- 41 - Fonction de transfert CAL INT VLF N° 32 (courbe N° 00106).
- 42 - Listing VLF N° 32 CAL INT.
- 43 - Suite.
- 44 - Fonction de transfert CAL INT VLF N° 33 (courbe N° 00103).
- 45 - Listing VLF N° 33 CAL INT.
- 46 - Suite
- 47 - Fonction de transfert
- 47 - Fonction de transfert CAL INT VLF N° 34 (courbe N° 00102).
- 48 - Listing VLF N° 34 CAL INT.
- 49 - Suite
- 50 - Schéma de principe du système de mesure des diagrammes de réception d'antennes ELF ou VLF.
- 51 - Diagramme ELF 10 Hz.
- 52 - Diagramme ELF 120 Hz.
- 53 - Diagramme ELF 450 Hz.
- 54 - Schéma de principe du système de mesure de la sensibilité des capteurs ELF - VLF.
- 55 - Densité de bruit en sortie préamplificateur ELF .
- 56 - Sensibilité ELF.
- 57 - Densité de bruit en sortie P.A. VLF.
- 58 - Sensibilité VLF.
- 59 - Fiche technique : consommation, poids, dimensions, température.
- 60 - Gain du PA ELF SEUL
- 61 - Gain du PA VLF SEUL

CRER

CENTRE DE RECHERCHE EN PHYSIQUE
DE L'ENVIRONNEMENT

MAGNETOMETRE SOL
CABLAGE DU BOITIER
ETANCHE LGE

Revisé	No plan	Nbre	Désignation	Matière
--------	---------	------	-------------	---------

Date: 7.6.76
Dessiné: F.X. SENE

Echelle:

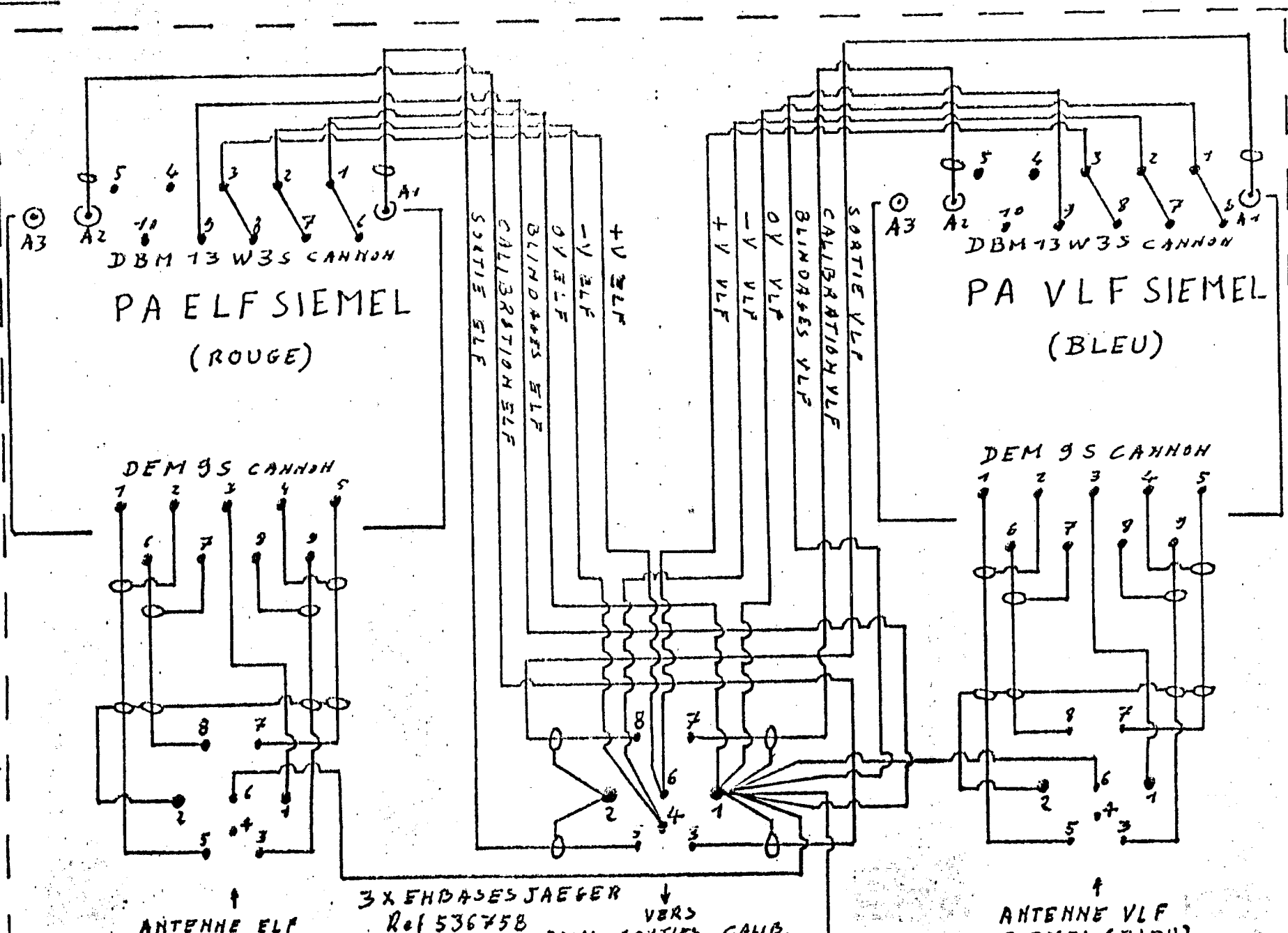

NO 6

FX

CMET

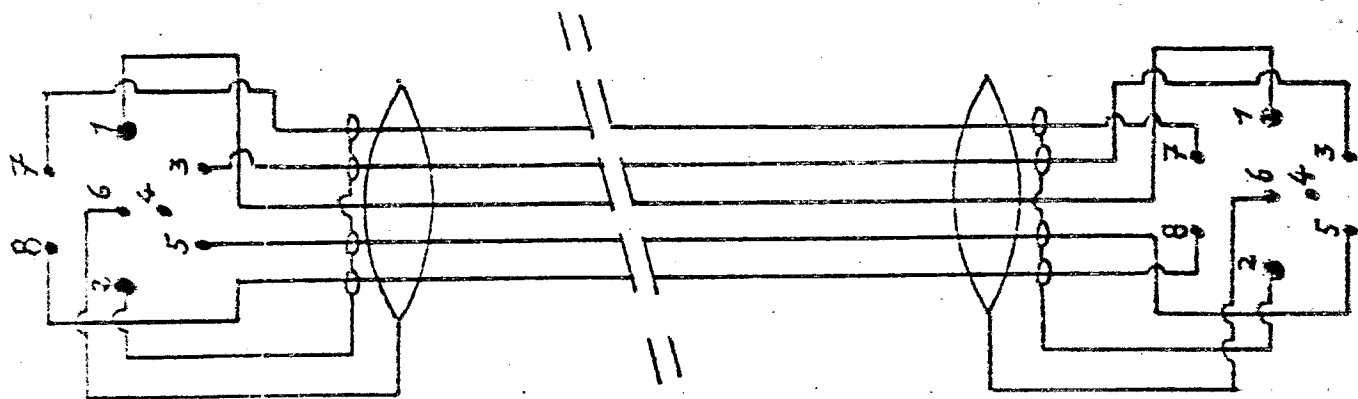

FICHES JAEGER
Ref 532404

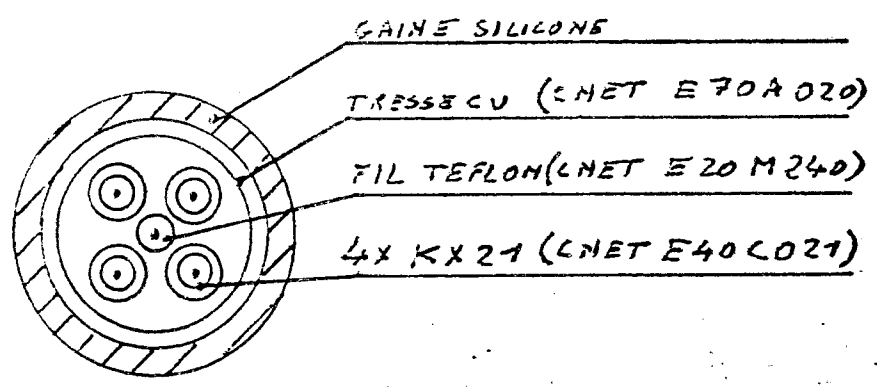

Repère	N° plan	Nbre	Désignation	Matière
			CENTRE DE RECHERCHE EN PHYSIQUE DE L'ENVIRONNEMENT	Date: 1.6.76 Dessiné: F.X.SENB

MAGNETOMETRE SOL
CABLE DE LIAISON ANTENNE

CNET

NO 7

Modifications

FICHE JAEGER
 Ref 532 404

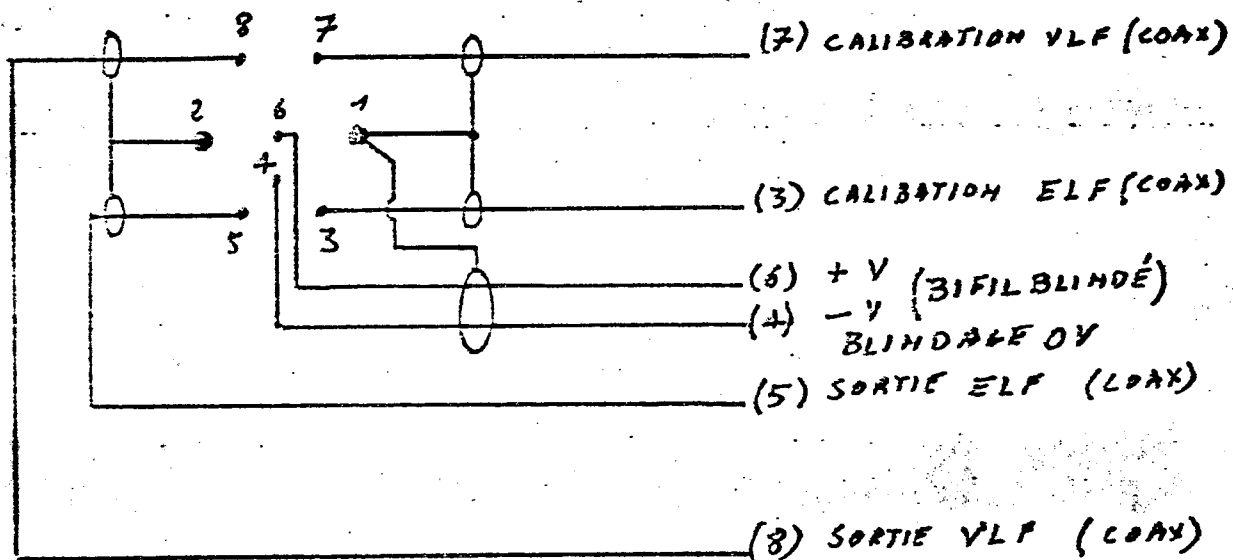

Repère	No plan	Nbre	Désignation	Matière	Date:	Echelle:
CREE	CENTRE DE RECHERCHE EN PHYSIQUE DE L'ENVIRONNEMENT				8 JUN 76	
			MAGNETOMETRE SOL		Dessiné: F.X. SENE	
			CABLE DE SORTIE. CAL ETALIM.			
						CNET
						NO 8

Modifications

MAGNETOMETRE SOL
ANTENNES SIEMEL

NO 9

CMET

CRER

CENTRE DE RECHERCHE EN PHYSIQUE
DE L'ENVIRONNEMENT

Date: 7.5.76
Dessiné: F. X SCHÉ

Echelle:

Repère No: Jan Nord

Désignation

Matière

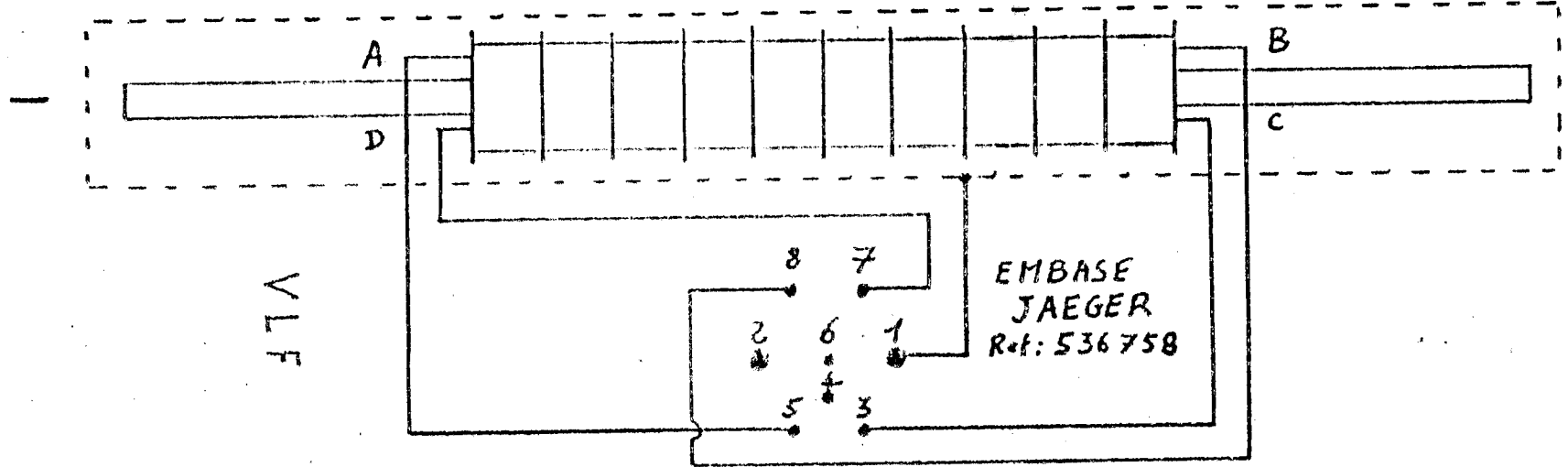

VLF

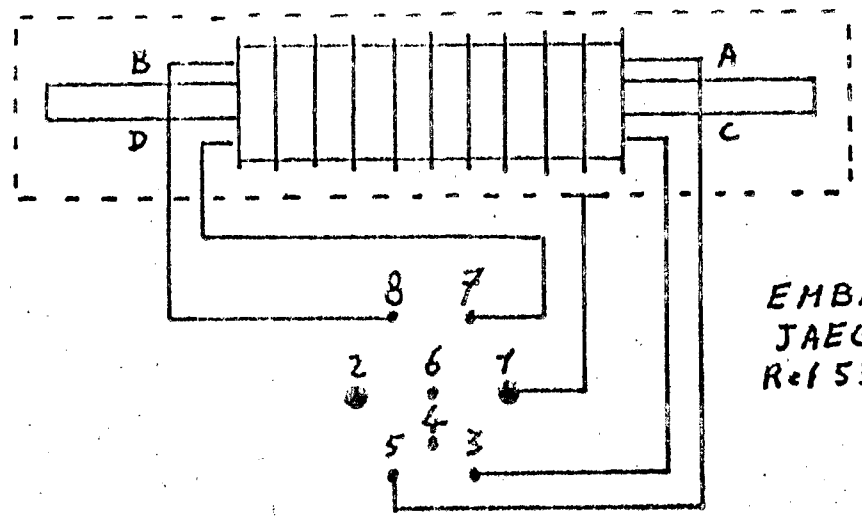

ELF

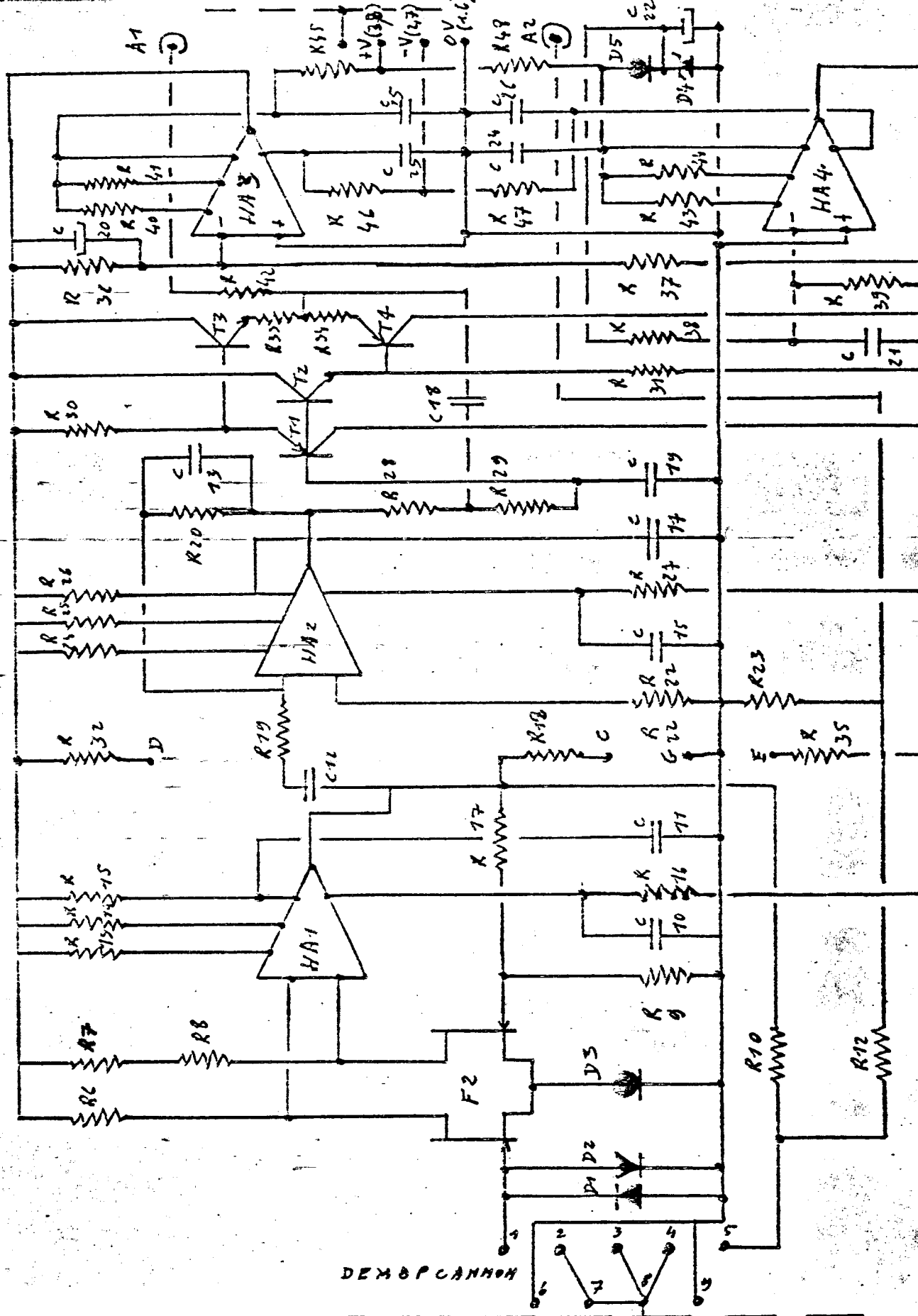

Receve	N°plan	Nbre	Désignation	Matière
--------	--------	------	-------------	---------



CENTRE DE RECHERCHE EN PHYSIQUE DE L'ENVIRONNEMENT

Date: 1. 6. 76
Dessiné: F. X. SENE

Echelle:

MAGNETOMETRE SOL
P.A. ELF. SIEMEL



CNET

NO 10

Modifications

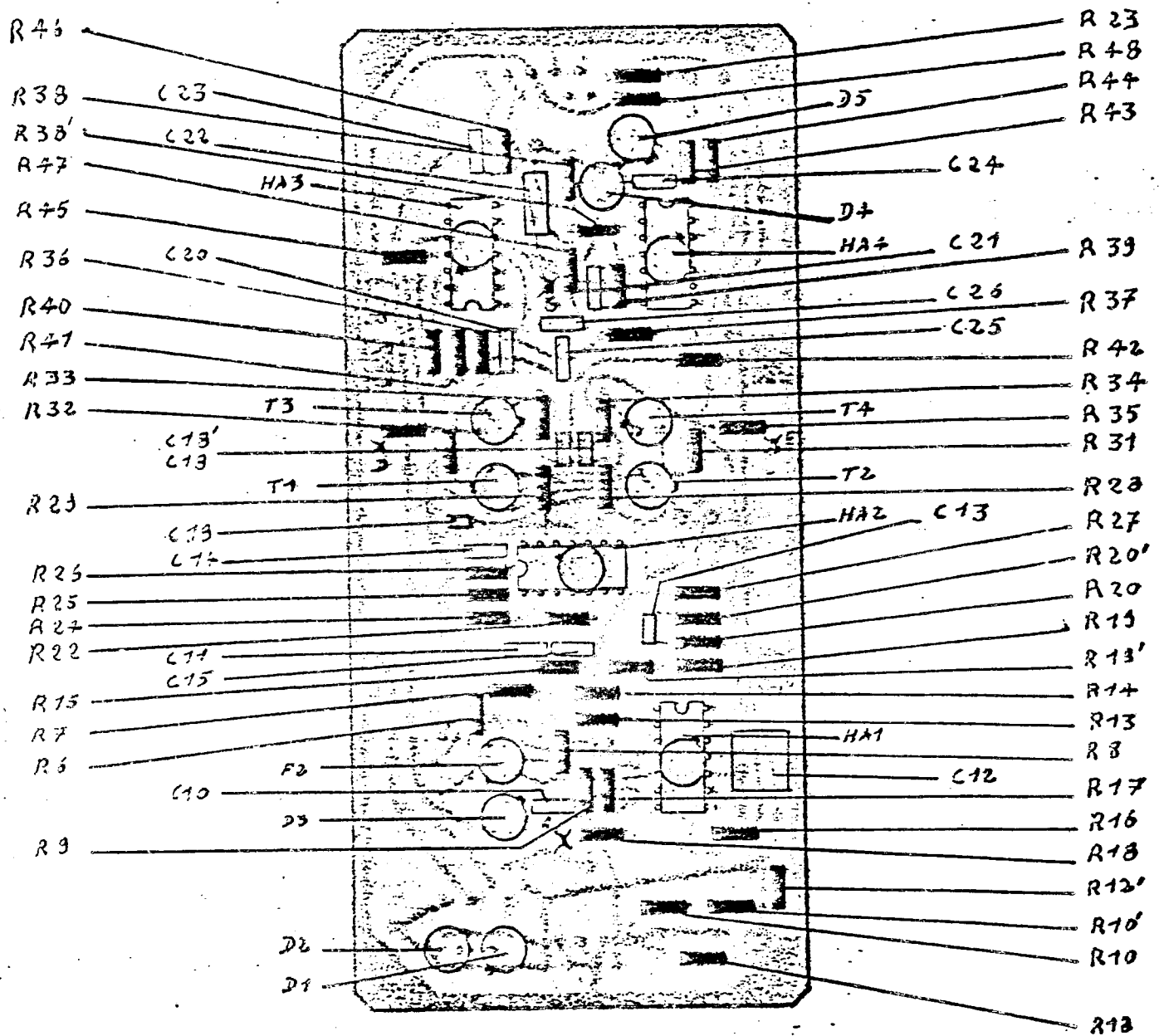

Repère	N° plan	Nbre	Désignation	Matière
--------	---------	------	-------------	---------

CENTRE DE RECHERCHE EN PHYSIQUE DE L'ENVIRONNEMENT

Date: 4 5 76
 Dessiné: P. X. SENE

Echelle:

MAGETOMETRE SOL
 PA ELF SIEMEL



CMET

NO 11

		RESISTANCES		
R6	22K Ω			
R7	22K Ω			
R8	A.D.J.			
R9	30 Ω			
R10	2,7K Ω			
R10'	10K Ω			
R12	47K Ω			
R12'	100K Ω			
R13	470K Ω			
R14	470K Ω			
R15	510 Ω			
R16	510 Ω			
R17	10K Ω			
R19	1K Ω			
R19	8,2K Ω			
R19'	1,8K Ω			
R20	1M Ω			
R20'	270K Ω			
R22	10K Ω			
R23	51 Ω			
R24	470K Ω			
R25	470K Ω			
R26	510 Ω			
R27	510 Ω			
R28	12K Ω			
R29	12K Ω			
R30	10K Ω			
R31	10K Ω			
R32	1K Ω			
R33	10 Ω			
R34	10 Ω			
R35	1K Ω			
R36	100K Ω			
R37	100K Ω			
R38	100K Ω			
R38'	105			
R39	130K Ω			
R40	470K Ω			
R41	470K Ω			
R42	47 Ω			
R43	470K Ω			
R44	470K Ω			
R45	51 Ω			
R46	51 Ω			
R47	51 Ω			
R48	51 Ω			

Repère	N° plan	N°	Désignation	Matière
--------	---------	----	-------------	---------

CRC	CENTRE DE RECHERCHE EN PHYSIQUE DE L'ENVIRONNEMENT	Date: 3.6.76	Echelle
		Dessiné: F.X.S	

	MAGNELOMETRE SOL		CNET
	PA ELF. SIEMEL		
		NO	12

		CONDENSATEURS	
C10	22mF		
C11	22mF		
C12	5x1uF		
C13	150uF		
C15	22mF		
C17	22mF		
C18	10mF		
C19	10mF		
C19	10mF		
C20	10uF		
C21	1uF		
C22	5,3uF		
C23	100mF		
C24	100mF		
C25	100mF		
C26	100mF		

		FETS	SILICONS
F2	2H5520		

		TRANSISTORS	
T1	2H2907A		
T2	2H222A		
T3	2H222A		
T4	2H2907A		

		DIODES	
D1	PAD1		
D2	PAD1		
D3	CL4710		
D4	FCT425		
D5	CL4710		

		CI	
HA1	HA2700		
HA2	HA2700		
HA3	HA2700		
HA4	HA2700		

Repère	N° plan	Nbre	Désignation	Matière	Date: 3.6.76	Echelle:
 CENTRE DE RECHERCHE EN PHYSIQUE DE L'ENVIRONNEMENT					Dessiné: F.X.S	

Modifications	MAGNETOMETRE SOL	 CNET
	PA ELF SIEMEL	
	NO 13	

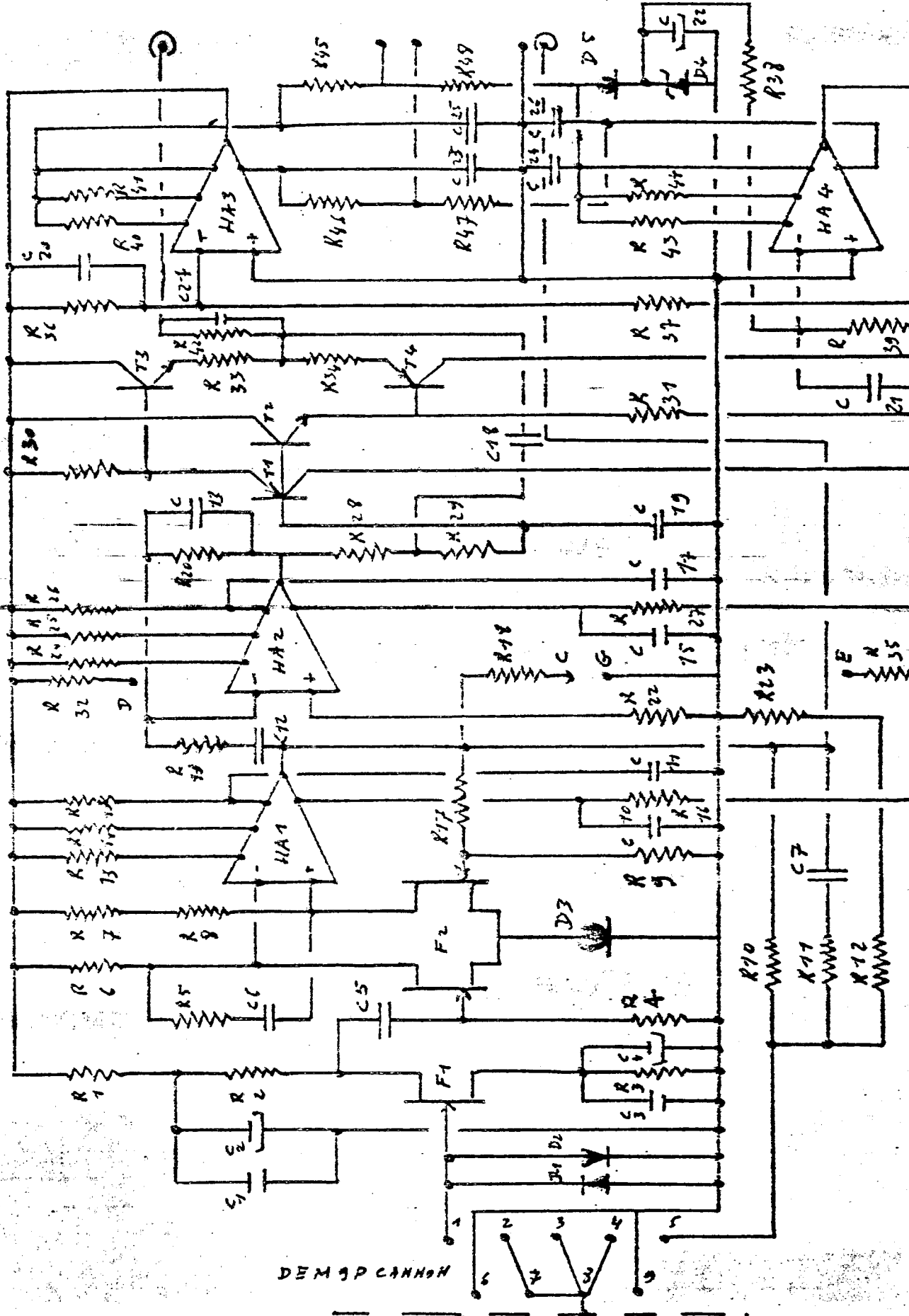

DEM 9 P CANNON

Reoère	N° plan	Nbre	Désignation	Matière
CENTRE DE RECHERCHE EN PHYSIQUE DE L'ENVIRONNEMENT				
				Date: 3. 6. 76
				Dessiné: F. SENE
				Echelle:

MAGNETOMETRE SOL
PA VLF SIEMEL

NO 14

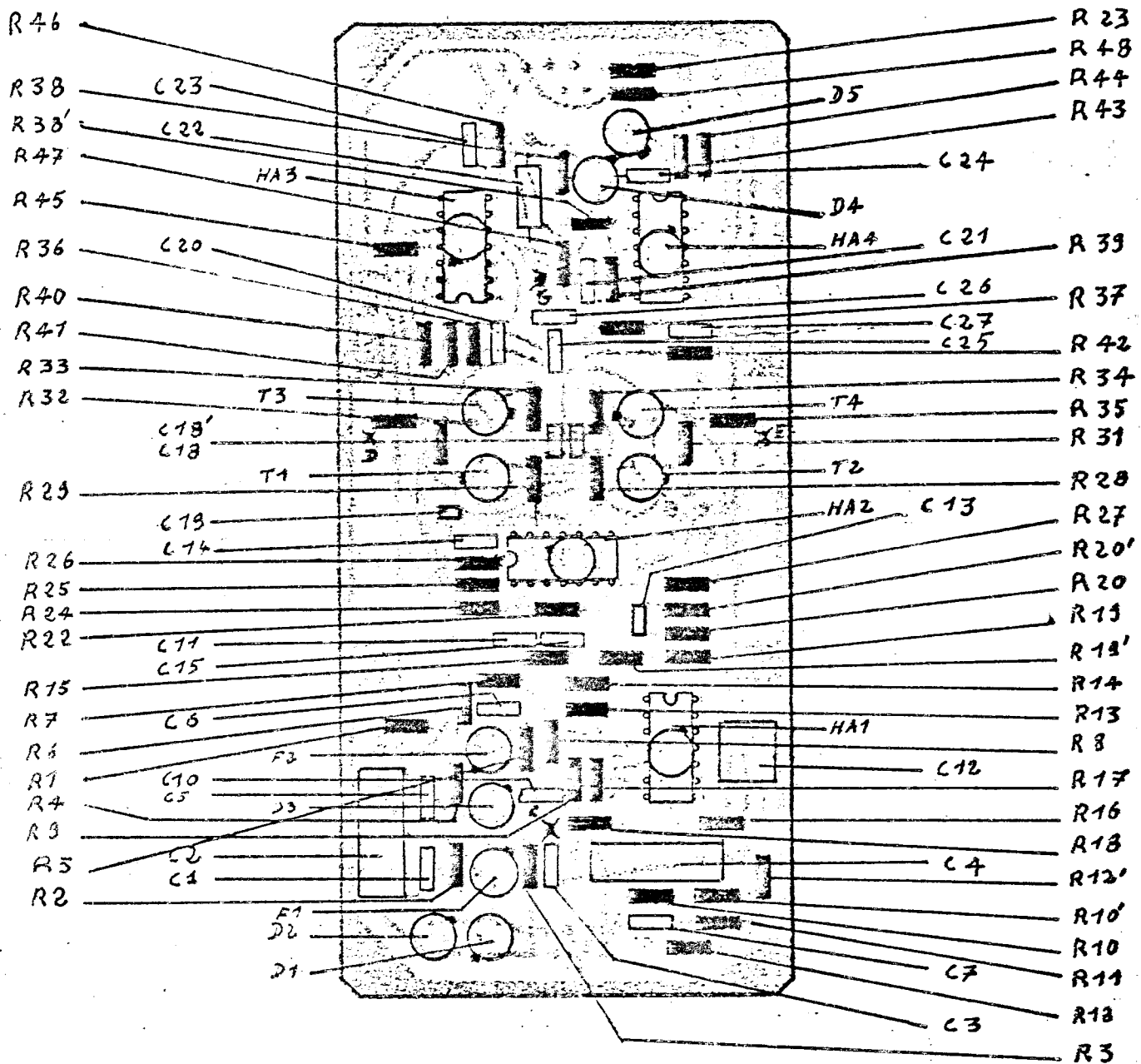

Repère	N°plan	Nbr	Désignation	Matière
--------	--------	-----	-------------	---------

CRPE

CENTRE DE RECHERCHE EN PHYSIQUE DE L'ENVIRONNEMENT

Date: 4 6 76
Dessiné: P. X. SZNE

Echelle:

MAGNETOMETRE SOL
PA V L F SIEMEL

CNET

Modifications

NO 15

R+3	470K Ω			
R4+	470K Ω			
R+5	51 Ω			
R+6	51 Ω			
R+7	51 Ω			
R+8	51 Ω			
		CONDENSATEURS		
C1	22nF			
C2	100 μ F			
C3	22nF			
C+	150 μ F			
C5	470nF			
C6	1nF			
C7	47pF			
C10	22nF			
C11	22nF			
C12	15nF			
C13	10pF			
C15	22nF			
C17	22nF			
C18	220pF			
C13'	220pF			
C13	220pF			
C20	1 μ F			
C21	1 μ F			
C22	5,3 μ F			
C23	22nF			
C24	22nF			
C25	22nF			
C26	22nF			
C27	270pF			
		FETS		
F1	TJ311		SILICONIX	
F2	2N5564		"	
		TRANSISTORS		
T1T+	2N2907A			
T2T3	2N2222A			
		DIODES		
D1D2	2AD1		SILICONIX	
D3D5	1N4750		"	
D4	FCT1125		FAIRCHILD	
		C I		
HA1	HA2700			
HA2	HA2700			
HA3	HA2700			
HA4	HA2700			
Repère	N°plan	Nbre	Désignation	Matière

CRIE

CENTRE DE RECHERCHE EN PHYSIQUE
DE L'ENVIRONNEMENT

Date: 4.6.76
Dessiné: F.X.SENÉ

Echelle

MAGETOMETRE SOL

P.A. VLF SIEMEL

CNET

NO 16

		RESISTANCES		
R1	150Ω			
R2	1KΩ			
R3	1KΩ			
R4	10KΩ			
R5	10KΩ			
R6	22KΩ			
R7	20KΩ			
R8	ADJ			
R9	330Ω			
R10	33KΩ			
R10'	10KΩ			
R11	1KΩ			
R12	13KΩ			
R12'	39KΩ			
R13	470KΩ			
R14	470KΩ			
R15	510Ω			
R16	510Ω			
R17	33KΩ			
R18	1KΩ			
R19	33KΩ			
R19'	3.3KΩ			
R20	300KΩ			
R20'	240KΩ			
R22	47KΩ			
R23	51Ω			
R24	470KΩ			
R25	470KΩ			
R26	510Ω			
R27	510Ω			
R28	15KΩ			
R29	15KΩ			
R30	10KΩ			
R31	10KΩ			
R32	1KΩ			
R33	10Ω			
R34	10Ω			
R35	1KΩ			
R36	100KΩ			
R37	100KΩ			
R38	91KΩ			
R38'	ADJ			
R39	130KΩ			
R40	470KΩ			
R41	470KΩ			
R42	51Ω			

Repère	N° plan	Nbre	Désignation	Matière
CREF CENTRE DE RECHERCHE EN PHYSIQUE DE L'ENVIRONNEMENT				
Date: 4.6.76				Echelle:
Dessiné: F.X.SENÉ				

MAGNETOMETRE SOL

P.A. VLF SIEMEL



CNET

NO 17

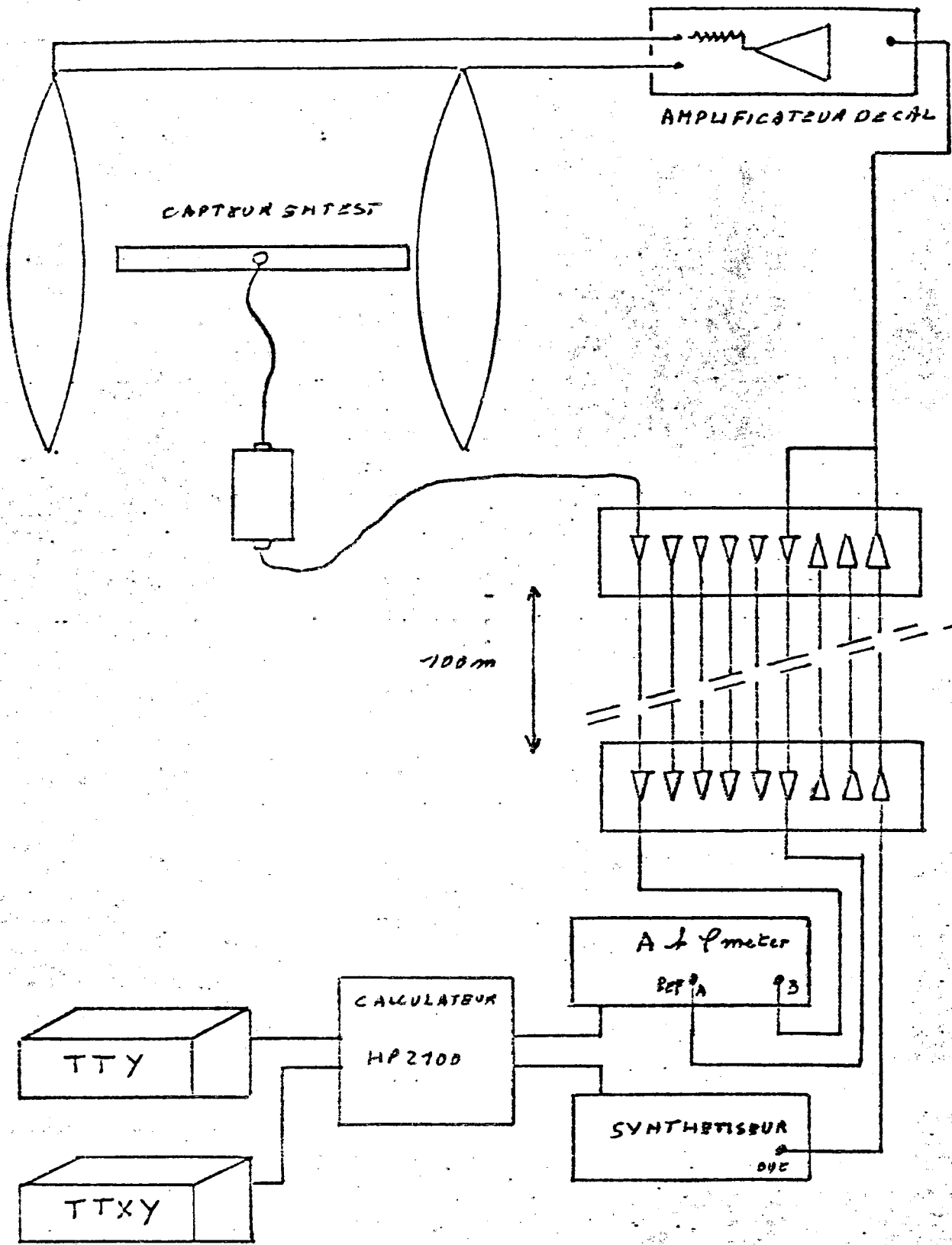

Recèrè	No plan	Nbre	Désignation	Matière
CREE	CENTRE DE RECHERCHE EN PHYSIQUE DE L'ENVIRONNEMENT		Date: 9 JUN 76	Echelle:
			Dessiné: F.X.SENE	

MAGNETOMETRE SOL
 CALIBRATION EXTERNE
 (MEASURE)

CNET

NO 18

A (v/g)

ϕ

19

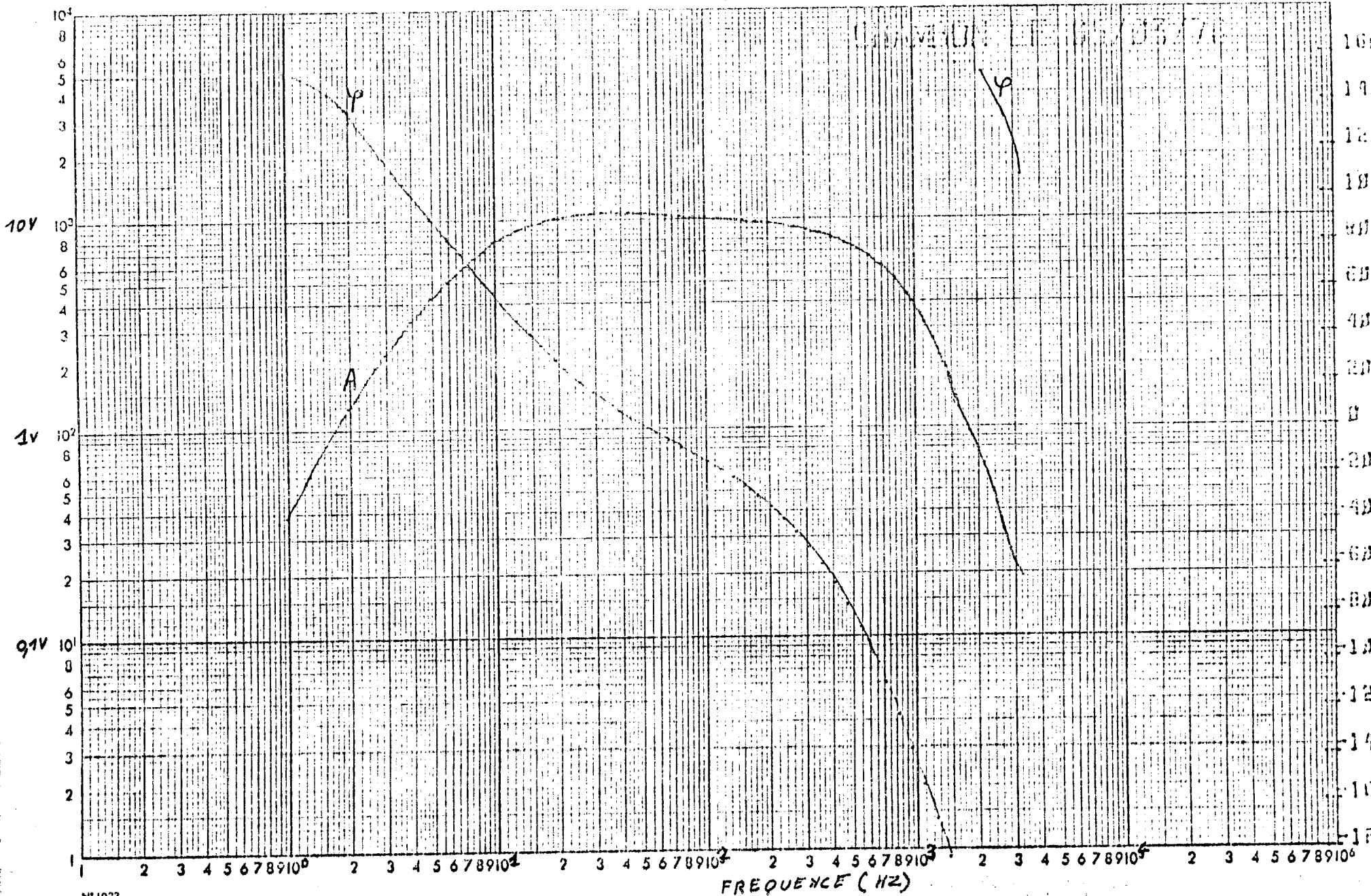

N° 1033

CAL EXT FN TRFT ELF NO 30

N° 00109

RUN
ELF

ELF

ELF

F= 1	HZ	B/A=-8.29998	DB	PHI= 154.6	DEG
.393551		V/GAMMA			
F= 2	HZ	B/A= 2.29993	DB	PHI= 139.3	DEG
1.32316		V/GAMMA			
F= 3	HZ	B/A= 7.42222	DB	PHI= 117.1	DEG
2.34424		V/GAMMA			
F= 4	HZ	B/A= 10.5	DB	PHI= 102.9	DEG
3.38343		V/GAMMA			
F= 5	HZ	B/A= 12.7999	DB	PHI= 91.9	DEG
4.36512		V/GAMMA			
F= 6	HZ	B/A= 14.2999	DB	PHI= 83.5	DEG
5.18796		V/GAMMA			
F= 7	HZ	B/A= 15.5	DB	PHI= 76.2999	DEG
5.95662		V/GAMMA			
F= 8	HZ	B/A= 16.5	DB	PHI= 70.1	DEG
6.68344		V/GAMMA			
F= 9	HZ	B/A= 17.2221	DB	PHI= 64.4	DEG
7.24442		V/GAMMA			
F= 10	HZ	B/A= 18.1	DB	PHI= 59.7999	DEG
8.23524		V/GAMMA			
F= 11	HZ	B/A= 18.4	DB	PHI= 55.2221	DEG
8.31766		V/GAMMA			
F= 13	HZ	B/A= 19.1	DB	PHI= 47.6	DEG
9.31569		V/GAMMA			
F= 15	HZ	B/A= 19.6	DB	PHI= 41.7221	DEG
9.5499		V/GAMMA			
F= 17	HZ	B/A= 19.7999	DB	PHI= 36.4	DEG
9.77229		V/GAMMA			
F= 20	HZ	B/A= 20.2999	DB	PHI= 30.1	DEG
13.3513		V/GAMMA			
F= 22	HZ	B/A= 20.4	DB	PHI= 26.5	DEG
13.4713		V/GAMMA			
F= 26	HZ	B/A= 20.6	DB	PHI= 20.7221	DEG
13.7152		V/GAMMA			
F= 30	HZ	B/A= 20.7221	DB	PHI= 16.1	DEG
13.3394		V/GAMMA			
F= 34	HZ	B/A= 20.7999	DB	PHI= 12.5	DEG
13.9647		V/GAMMA			
F= 40	HZ	B/A= 20.7999	DB	PHI= 8	DEG
13.9647		V/GAMMA			
F= 45	HZ	B/A= 20.7999	DB	PHI= 5	DEG
13.9647		V/GAMMA			
F= 52	HZ	B/A= 20.7221	DB	PHI= 1.59998	DEG
13.3394		V/GAMMA			
F= 60	HZ	B/A= 20.6	DB	PHI=-1.72213	DEG
13.7152		V/GAMMA			
F= 69	HZ	B/A= 20.5	DB	PHI=-4.79968	DEG
13.5925		V/GAMMA			
F= 79	HZ	B/A= 20.5	DB	PHI=-7.69983	DEG
13.5925		V/GAMMA			
F= 91	HZ	B/A= 20.4	DB	PHI=-10.7999	DEG
13.4713		V/GAMMA			

№ 0010

59 MARS 1976

ELF 30

CAL EXT

F= 135 HZ	B/A= 20.2999	DB	PHI=-14.0005	DEG
13.3513	V/GAMMA			
F= 121 HZ	B/A= 20.2001	DB	PHI=-17.4	DEG
13.233	V/GAMMA			
F= 139 HZ	B/A= 20.1	DB	PHI=-20.9	DEG
13.1158	V/GAMMA			
F= 159 HZ	B/A= 20	DB	PHI=-24.6	DEG
13.	V/GAMMA			
F= 163 HZ	B/A= 19.7999	DB	PHI=-28.7999	DEG
9.77229	V/GAMMA			
F= 211 HZ	B/A= 19.7001	DB	PHI=-33.6	DEG
9.66059	V/GAMMA			
F= 242 HZ	B/A= 19.5	DB	PHI=-38.7001	DEG
9.44051	V/GAMMA			
F= 273 HZ	B/A= 19.2999	DB	PHI=-44.502	DEG
9.22554	V/GAMMA			
F= 319 HZ	B/A= 19	DB	PHI=-51.002	DEG
8.91251	V/GAMMA			
F= 367 HZ	B/A= 18.7001	DB	PHI=-58.2999	DEG
8.61001	V/GAMMA			
F= 422 HZ	B/A= 18.2999	DB	PHI=-66.5039	DEG
8.22236	V/GAMMA			
F= 485 HZ	B/A= 17.7999	DB	PHI=-75.7001	DEG
7.76241	V/GAMMA			
F= 557 HZ	B/A= 17.2001	DB	PHI=-85.7999	DEG
7.24442	V/GAMMA			
F= 609 HZ	B/A= 16.5	DB	PHI=-97.0039	DEG
6.68344	V/GAMMA			
F= 705 HZ	B/A= 15.5	DB	PHI=-109.504	DEG
5.95662	V/GAMMA			
F= 844 HZ	B/A= 14.2999	DB	PHI=-123.004	DEG
5.15796	V/GAMMA			
F= 973 HZ	B/A= 12.7999	DB	PHI=-137.4	DEG
4.35512	V/GAMMA			
F= 1114 HZ	B/A= 10.9	DB	PHI=-152.2	DEG
3.50753	V/GAMMA			
F= 1279 HZ	B/A= 8.5	DB	PHI=-167.2	DEG
2.66073	V/GAMMA			
F= 1473 HZ	B/A= 5.79993	DB	PHI=-182.8	DEG
1.94933	V/GAMMA			
F= 1633 HZ	B/A= 1.90002	DB	PHI= 156.4	DEG
1.24452	V/GAMMA			
F= 1940 HZ	B/A=-.40004	DB	PHI= 170.8	DEG
.954939	V/GAMMA			
F= 2223 HZ	B/A=-3.50012	DB	PHI= 152.7	DEG
.653334	V/GAMMA			
F= 2559 HZ	B/A=-7.29968	DB	PHI= 141.7	DEG
.431535	V/GAMMA			
F= 2940 HZ	B/A=-11.6	DB	PHI= 130.7	DEG
.250028	V/GAMMA			
F= 3377 HZ	B/A=-14.2001	DB	PHI= 108.4	DEG
.194983	V/GAMMA			

ELF 30

CALEXT

A (V/γ)

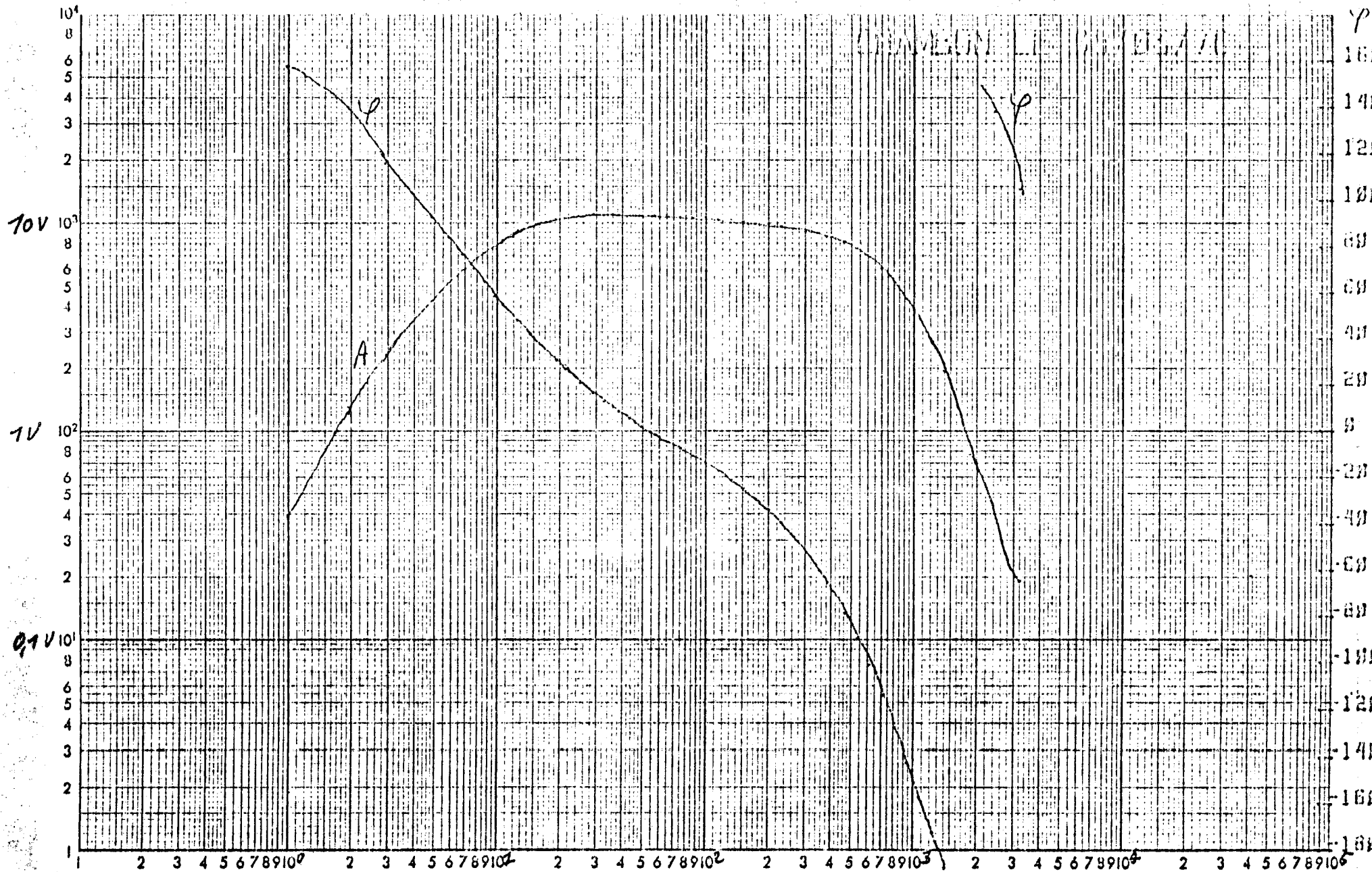

N° 1033

CAJ EXT EN TDET ELE NO 21

FREQUENCY (HZ)

00108

DB MARS 1976

ELF 37

CAL EXT

F	Hz	ELF - ?	DB	PHI =	ELF	DEG
F= 1	3.98137	B/A= 12	DB	PHI= 157.8		DEG
		V/GAMMA				
F= 2	1.31826	B/A= 2.40002	DB	PHI= 140.5		DEG
		V/GAMMA				
F= 3	2.37137	B/A= 7.5	DB	PHI= 116.3		DEG
		V/GAMMA				
F= 4	3.34966	B/A= 10.5	DB	PHI= 103.8		DEG
		V/GAMMA				
F= 5	4.31523	B/A= 12.7001	DB	PHI= 92.7999		DEG
		V/GAMMA				
F= 6	5.24809	B/A= 14.4	DB	PHI= 84.2999		DEG
		V/GAMMA				
F= 7	6.32558	B/A= 15.6	DB	PHI= 77		DEG
		V/GAMMA				
F= 8	6.76081	B/A= 16.6	DB	PHI= 70.7001		DEG
		V/GAMMA				
F= 9	7.32813	B/A= 17.2999	DB	PHI= 65.1		DEG
		V/GAMMA				
F= 10	7.35238	B/A= 17.9	DB	PHI= 59.2001		DEG
		V/GAMMA				
F= 11	8.41395	B/A= 18.5	DB	PHI= 55.9		DEG
		V/GAMMA				
F= 13	9.12019	B/A= 19.2001	DB	PHI= 48.5		DEG
		V/GAMMA				
F= 15	9.56059	B/A= 19.7001	DB	PHI= 42.2001		DEG
		V/GAMMA				
F= 17	10.233	B/A= 20.2001	DB	PHI= 37.7001		DEG
		V/GAMMA				
F= 20	10.5925	B/A= 20.5	DB	PHI= 30.7001		DEG
		V/GAMMA				
F= 22	10.7152	B/A= 20.6	DB	PHI= 27		DEG
		V/GAMMA				
F= 26	10.9647	B/A= 20.7999	DB	PHI= 21.2001		DEG
		V/GAMMA				
F= 30	11.2202	B/A= 21	DB	PHI= 16.9		DEG
		V/GAMMA				
F= 34	11.3918	B/A= 20.9	DB	PHI= 12.9		DEG
		V/GAMMA				
F= 40	11.3918	B/A= 20.9	DB	PHI= 8.5		DEG
		V/GAMMA				
F= 45	11.3918	B/A= 20.9	DB	PHI= 5.5		DEG
		V/GAMMA				
F= 52	10.9647	B/A= 20.7999	DB	PHI= 2.20007		DEG
		V/GAMMA				
F= 60	10.9647	B/A= 20.7999	DB	PHI=-1.20013		DEG
		V/GAMMA				
F= 69	10.9647	B/A= 20.7999	DB	PHI=-4.29968		DEG
		V/GAMMA				
F= 79	10.8394	B/A= 20.7001	DB	PHI=-7.29968		DEG
		V/GAMMA				

F= 91	HZ	B/A= 20.6	DB	PHI=-10.4	DEG
10.7152		V/GAMMA			
F= 105	HZ	B/A= 20.6	DB	PHI=-13.6	DEG
10.7152		V/GAMMA			
F= 121	HZ	B/A= 20.4	DB	PHI=-17.001	DEG
10.4713		V/GAMMA			
F= 139	HZ	B/A= 20.4	DB	PHI=-20.6	DEG
10.4713		V/GAMMA			
F= 159	HZ	B/A= 20.2001	DB	PHI=-24.4	DEG
10.233		V/GAMMA			
F= 183	HZ	B/A= 20.1	DB	PHI=-28.7999	DEG
10.1158		V/GAMMA			
F= 211	HZ	B/A= 20	DB	PHI=-33.7999	DEG
10.		V/GAMMA			
F= 242	HZ	B/A= 19.7999	DB	PHI=-39.1	DEG
9.77229		V/GAMMA			
F= 278	HZ	B/A= 19.6	DB	PHI=-45.2001	DEG
9.5499		V/GAMMA			
F= 319	HZ	B/A= 19.4	DB	PHI=-52.002	DEG
9.33257		V/GAMMA			
F= 367	HZ	B/A= 19.1	DB	PHI=-59.7999	DEG
9.01569		V/GAMMA			
F= 422	HZ	B/A= 18.7001	DB	PHI=-68.5039	DEG
8.61001		V/GAMMA			
F= 485	HZ	B/A= 18.2001	DB	PHI=-78.2001	DEG
8.12837		V/GAMMA			
F= 557	HZ	B/A= 17.6	DB	PHI=-88.9	DEG
7.58576		V/GAMMA			
F= 639	HZ	B/A= 16.7999	DB	PHI=-100.7	DEG
6.91825		V/GAMMA			
F= 735	HZ	B/A= 15.7001	DB	PHI=-113.7	DEG
6.09542		V/GAMMA			
F= 844	HZ	B/A= 14.5	DB	PHI=-127.504	DEG
5.30384		V/GAMMA			
F= 970	HZ	B/A= 12.7999	DB	PHI=-142.1	DEG
4.36512		V/GAMMA			
F= 1114	HZ	B/A= 10.7999	DB	PHI=-157.008	DEG
3.46734		V/GAMMA			
F= 1279	HZ	B/A= 8.5	DB	PHI=-171.9	DEG
2.66073		V/GAMMA			
F= 1470	HZ	B/A= 5.79993	DB	PHI=-137.2	DEG
1.94983		V/GAMMA			
F= 1688	HZ	B/A= 2.5	DB	PHI= 152.9	DEG
1.33352		V/GAMMA			
F= 1940	HZ	B/A=-2.2002	DB	PHI= 168.3	DEG
.77623		V/GAMMA			
F= 2228	HZ	B/A=-4.19983	DB	PHI= 149.3	DEG
.616607		V/GAMMA			
F= 2559	HZ	B/A=-7.89978	DB	PHI= 138.2	DEG
.402727		V/GAMMA			
F= 2940	HZ	B/A=-12.2001	DB	PHI= 127.6	DEG
.245469		V/GAMMA			
F= 3377	HZ	B/A=-14.2999	DB	PHI= 104.8	DEG
.192754		V/GAMMA			

ELF 37

CAL EXT (su)

A (V/γ)

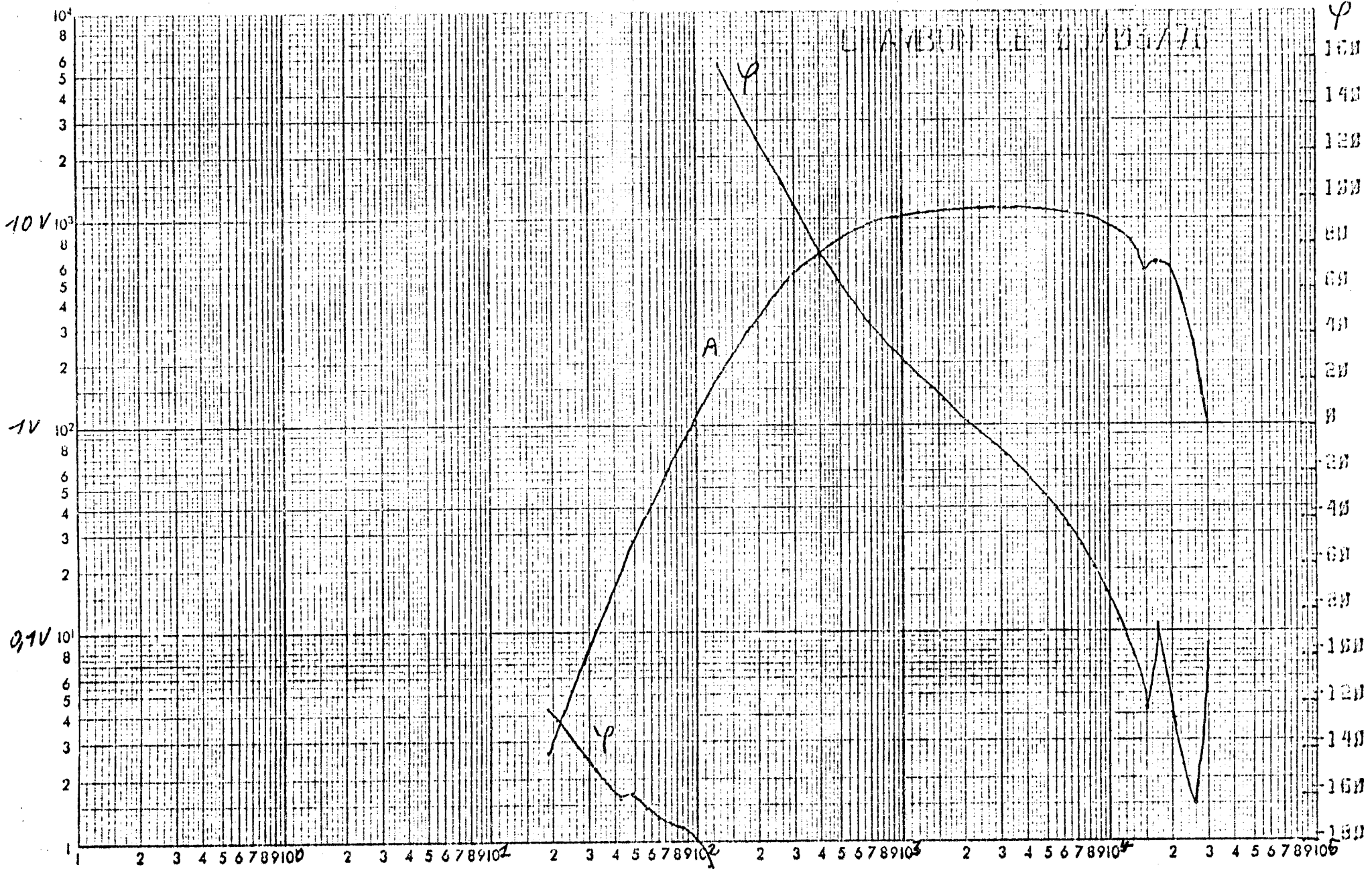

25

N° 1033

CAL EXT FN TRFT VLF NO 32

FREQUENCY (Hz)

N° 00105

*****		*****		*****	
VLF		VLF		VLF	
F= 20	HZ	B/A=-31.4	DB	PHI=-122.504	DEG
2.69153E-02		V/GAMMA			
F= 22	HZ	B/A=-29.2001	DB	PHI=-127.3	DEG
3.46734E-02		V/GAMMA			
F= 26	HZ	B/A=-25.5002	DB	PHI=-135.008	DEG
5.33869E-02		V/GAMMA			
F= 30	HZ	B/A=-22.4001	DB	PHI=-142.6	DEG
7.58564E-02		V/GAMMA			
F= 34	HZ	B/A=-19.7999	DB	PHI=-148.1	DEG
.10233		V/GAMMA			
F= 40	HZ	B/A=-16.4	DB	PHI=-155.3	DEG
.151356		V/GAMMA			
F= 45	HZ	B/A=-14.2999	DB	PHI=-161.008	DEG
.192754		V/GAMMA			
F= 52	HZ	B/A=-11.0005	DB	PHI=-158.4	DEG
.281822		V/GAMMA			
F= 60	HZ	B/A=-8.70007	DB	PHI=-165.2	DEG
.367279		V/GAMMA			
F= 69	HZ	B/A=-6.39978	DB	PHI=-169.508	DEG
.478642		V/GAMMA			
F= 79	HZ	B/A=-4.09973	DB	PHI=-170.9	DEG
.623754		V/GAMMA			
F= 91	HZ	B/A=-1.70013	DB	PHI=-173.1	DEG
.82223		V/GAMMA			
F= 105	HZ	B/A= .599976	DB	PHI=-177.9	DEG
1.07152		V/GAMMA			
F= 121	HZ	B/A= 2.79993	DB	PHI=-189.508	DEG
1.38037		V/GAMMA			
F= 139	HZ	B/A= 4.79993	DB	PHI= 158.3	DEG
1.73779		V/GAMMA			
F= 159	HZ	B/A= 6.70007	DB	PHI= 146.9	DEG
2.16274		V/GAMMA			
F= 183	HZ	B/A= 8.5	DB	PHI= 136.2	DEG
2.56073		V/GAMMA			
F= 211	HZ	B/A= 10.4	DB	PHI= 125.6	DEG
3.31132		V/GAMMA			
F= 242	HZ	B/A= 12	DB	PHI= 116.1	DEG
3.98107		V/GAMMA			
F= 273	HZ	B/A= 13.5	DB	PHI= 106.2	DEG
4.73151		V/GAMMA			
F= 319	HZ	B/A= 14.7999	DB	PHI= 96.9	DEG
5.49536		V/GAMMA			
F= 367	HZ	B/A= 15.9	DB	PHI= 87.5	DEG
6.23737		V/GAMMA			
F= 422	HZ	B/A= 17	DB	PHI= 77.7999	DEG
7.07946		V/GAMMA			
F= 485	HZ	B/A= 17.7999	DB	PHI= 69.2001	DEG
7.76241		V/GAMMA			
F= 557	HZ	B/A= 18.5	DB	PHI= 61.1	DEG
8.41395		V/GAMMA			
F= 639	HZ	B/A= 19.1	DB	PHI= 53.4	DEG
9.01569		V/GAMMA			
F= 735	HZ	B/A= 19.6	DB	PHI= 46.1	DEG
9.5499		V/GAMMA			
F= 844	HZ	B/A= 20	DB	PHI= 39.4	DEG
10.		V/GAMMA			
F= 970	HZ	B/A= 20.2999	DB	PHI= 33	DEG
10.3513		V/GAMMA			
F= 1114	HZ	B/A= 20.5	DB	PHI= 27.1	DEG
10.5925		V/GAMMA			

NO 00105

30 MAR 19

VLF 32

CAL EXT

F= 1279	HZ	B/A= 20.7001	DB	PHI= 21.6	DEG
10.8394	V/GAMMA				
F= 1470	HZ	B/A= 20.7999	DB	PHI= 16.2999	DEG
10.9647	V/GAMMA				
F= 1688	HZ	B/A= 20.9	DB	PHI= 11.4	DEG
11.0918	V/GAMMA				
F= 1940	HZ	B/A= 21	DB	PHI= 6.5	DEG
11.2202	V/GAMMA				
F= 2228	HZ	B/A= 21.1	DB	PHI= 1.70007	DEG
11.3501	V/GAMMA				
F= 2559	HZ	B/A= 21.2001	DB	PHI=-2.90015	DEG
11.4816	V/GAMMA				
F= 2940	HZ	B/A= 21.2001	DB	PHI=-7.69933	DEG
11.4816	V/GAMMA				
F= 3377	HZ	B/A= 21.2001	DB	PHI=-12.7001	DEG
11.4816	V/GAMMA				
F= 3880	HZ	B/A= 21.2001	DB	PHI=-17.9	DEG
11.4816	V/GAMMA				
F= 4457	HZ	B/A= 21.1	DB	PHI=-23.6	DEG
11.3501	V/GAMMA				
F= 5119	HZ	B/A= 21	DB	PHI=-29.6	DEG
11.2202	V/GAMMA				
F= 5881	HZ	B/A= 20.9	DB	PHI=-36.2001	DEG
11.0918	V/GAMMA				
F= 6755	HZ	B/A= 20.7001	DB	PHI=-43.6	DEG
10.8394	V/GAMMA				
F= 7760	HZ	B/A= 20.5	DB	PHI=-51.7999	DEG
10.5925	V/GAMMA				
F= 8914	HZ	B/A= 20.2001	DB	PHI=-61.2001	DEG
10.233	V/GAMMA				
F= 10240	HZ	B/A= 19.7001	DB	PHI=-71.9	DEG
9.66059	V/GAMMA				
F= 11762	HZ	B/A= 19	DB	PHI=-84.6	DEG
8.91251	V/GAMMA				
F= 13511	HZ	B/A= 18	DB	PHI=-99.7001	DEG
7.94328	V/GAMMA				
F= 15520	HZ	B/A= 15	DB	PHI=-122.3	DEG
5.62341	V/GAMMA				
F= 17828	HZ	B/A= 16	DB	PHI=-86.1	DEG
6.30958	V/GAMMA				
F= 20480	HZ	B/A= 15.5	DB	PHI=-124.7	DEG
5.95662	V/GAMMA				
F= 23525	HZ	B/A= 12.7001	DB	PHI=-147.008	DEG
4.31523	V/GAMMA				
F= 27023	HZ	B/A= 7.70007	DB	PHI=-163.6	DEG
2.42663	V/GAMMA				
F= 31042	HZ	B/A= 9.99756E-02	DB	PHI=-94.9	DEG
1.01158	V/GAMMA				
F= 35657.	HZ	B/A= 17.7999	DB	PHI=-96.9	DEG
7.76241	V/GAMMA				
F= 40960.	HZ	B/A= 16.9	DB	PHI= 161	DEG
6.99844	V/GAMMA				
F= 47051.	HZ	B/A= 10.6	DB	PHI= 123.2	DEG
3.38843	V/GAMMA				
F= 54047.	HZ	B/A= 5.40002	DB	PHI= 98.2999	DEG
1.86209	V/GAMMA				
F= 62084.	HZ	B/A= .299927	DB	PHI= 77.9	DEG
1.03513	V/GAMMA				
F= 71316.	HZ	B/A=-4.19983	DB	PHI= 68.2001	DEG
.616607	V/GAMMA				

YLF 32

CAL EXT(SUITE)

$\Lambda(V/\gamma)$

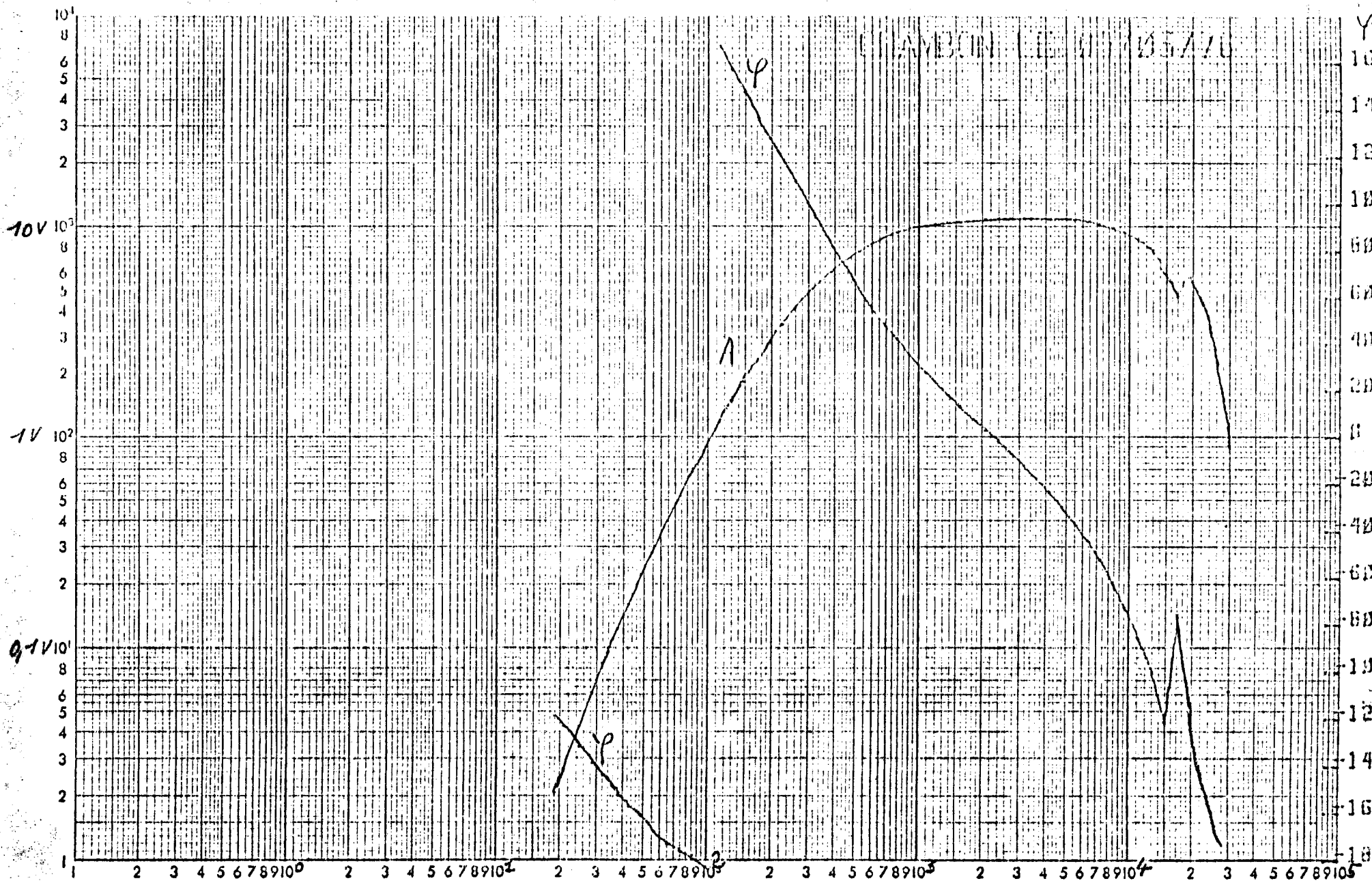

28

N° 1033

CAL EXT EN TOFT VLE NO 177

FREQUENCY (HZ)

VLF		VLF		VLF	
F= 20 HZ	B/A=-33.6	DB	PHI=-118.8	DEG	
2.08930E-02	V/GAMMA				
F= 22 HZ	B/A=-31.2999	DB	PHI=-123.2	DEG	
2.72272E-02	V/GAMMA				
F= 26 HZ	B/A=-27.3998	DB	PHI=-131.508	DEG	
4.26590E-02	V/GAMMA				
F= 30 HZ	B/A=-24.1998	DB	PHI=-138.6	DEG	
6.16607E-02	V/GAMMA				
F= 34 HZ	B/A=-21.4001	DB	PHI=-143.7	DEG	
8.51130E-02	V/GAMMA				
F= 40 HZ	B/A=-18.1	DB	PHI=-152.1	DEG	
.124452	V/GAMMA				
F= 45 HZ	B/A=-15.7999	DB	PHI=-157.1	DEG	
.162182	V/GAMMA				
F= 52 HZ	B/A=-12.9	DB	PHI=-160.8	DEG	
.226464	V/GAMMA				
F= 60 HZ	B/A=-10.2999	DB	PHI=-167.8	DEG	
.305495	V/GAMMA				
F= 69 HZ	B/A=-7.89978	DB	PHI=-173.008	DEG	
.402727	V/GAMMA				
F= 79 HZ	B/A=-5.59973	DB	PHI=-174.7	DEG	
.524824	V/GAMMA				
F= 91 HZ	B/A=-3.30005	DB	PHI=-177.508	DEG	
.683908	V/GAMMA				
F= 105 HZ	B/A=-.900055	DB	PHI=-182.3	DEG	
.901565	V/GAMMA				
F= 121 HZ	B/A= 1.40002	DB	PHI= 167.5	DEG	
1.1749	V/GAMMA				
F= 139 HZ	B/A= 3.5	DB	PHI= 157.4	DEG	
1.49624	V/GAMMA				
F= 159 HZ	B/A= 5.29993	DB	PHI= 147.6	DEG	
1.84076	V/GAMMA				
F= 183 HZ	B/A= 7.29993	DB	PHI= 136.9	DEG	
2.31703	V/GAMMA				
F= 211 HZ	B/A= 9.09998	DB	PHI= 128	DEG	
2.85131	V/GAMMA				
F= 242 HZ	B/A= 10.7999	DB	PHI= 118.8	DEG	
3.46734	V/GAMMA				
F= 273 HZ	B/A= 12.4	DB	PHI= 109.8	DEG	
4.16371	V/GAMMA				
F= 319 HZ	B/A= 13.7001	DB	PHI= 100.5	DEG	
4.84176	V/GAMMA				
F= 367 HZ	B/A= 15	DB	PHI= 91.2001	DEG	
5.62341	V/GAMMA				
F= 422 HZ	B/A= 16.1	DB	PHI= 81.7999	DEG	
6.33262	V/GAMMA				
F= 485 HZ	B/A= 17	DB	PHI= 73.1	DEG	
7.07946	V/GAMMA				
F= 557 HZ	B/A= 17.7999	DB	PHI= 64.7999	DEG	
7.76241	V/GAMMA				
F= 639 HZ	B/A= 18.5	DB	PHI= 57	DEG	
8.41395	V/GAMMA				
F= 735 HZ	B/A= 19.1	DB	PHI= 49.4	DEG	
9.01569	V/GAMMA				
F= 844 HZ	B/A= 19.5	DB	PHI= 42.2999	DEG	
9.44061	V/GAMMA				
F= 970 HZ	B/A= 19.9	DB	PHI= 35.7001	DEG	
9.88556	V/GAMMA				
F= 1114 HZ	B/A= 20.1	DB	PHI= 29.5	DEG	
10.1158	V/GAMMA				

7-9 MARS 1976
 # 00104
 VLF 33
 CAL EXT

F= 1279	HZ	B/A= 20.2999	DB	PHI= 23.7999	DEG
10.3513	V/GAMMA				
F= 1470	HZ	B/A= 20.5	DB	PHI= 18.2999	DEG
10.5925	V/GAMMA				
F= 1688	HZ	B/A= 20.5	DB	PHI= 13	DEG
10.5925	V/GAMMA				
F= 1940	HZ	B/A= 20.6	DB	PHI= 7.90002	DEG
10.7152	V/GAMMA				
F= 2228	HZ	B/A= 20.7999	DB	PHI= 3	DEG
10.9647	V/GAMMA				
F= 2559	HZ	B/A= 20.9	DB	PHI=-1.90009	DEG
11.0918	V/GAMMA				
F= 2940	HZ	B/A= 20.9	DB	PHI=-6.79968	DEG
11.0918	V/GAMMA				
F= 3377	HZ	B/A= 20.9	DB	PHI=-12.0005	DEG
11.0918	V/GAMMA				
F= 3880	HZ	B/A= 20.9	DB	PHI=-17.4	DEG
11.0918	V/GAMMA				
F= 4457	HZ	B/A= 20.7999	DB	PHI=-23.1	DEG
10.9647	V/GAMMA				
F= 5119	HZ	B/A= 20.7999	DB	PHI=-29.2999	DEG
10.9647	V/GAMMA				
F= 5381	HZ	B/A= 20.7001	DB	PHI=-36.1	DEG
10.8394	V/GAMMA				
F= 6755	HZ	B/A= 20.5	DB	PHI=-43.6	DEG
10.5925	V/GAMMA				
F= 7760	HZ	B/A= 20.2999	DB	PHI=-52.002	DEG
10.3513	V/GAMMA				
F= 8914	HZ	B/A= 19.9	DB	PHI=-61.502	DEG
9.88556	V/GAMMA				
F= 10240	HZ	B/A= 19.5	DB	PHI=-72.4	DEG
9.44061	V/GAMMA				
F= 11762	HZ	B/A= 18.9	DB	PHI=-85.1	DEG
8.81052	V/GAMMA				
F= 13511	HZ	B/A= 17.9	DB	PHI=-100.1	DEG
7.85233	V/GAMMA				
F= 15520	HZ	B/A= 15.6	DB	PHI=-121.3	DEG
6.02553	V/GAMMA				
F= 17828	HZ	B/A= 13.4	DB	PHI=-75.4	DEG
4.67737	V/GAMMA				
F= 20430	HZ	B/A= 15.4	DB	PHI=-124.6	DEG
5.83845	V/GAMMA				
F= 23525	HZ	B/A= 12.7001	DB	PHI=-149.2	DEG
4.31523	V/GAMMA				
F= 27023	HZ	B/A= 7.79993	DB	PHI=-167.508	DEG
2.45469	V/GAMMA				
F= 31042	HZ	B/A=-.799957	DB	PHI=-108.1	DEG
.912015	V/GAMMA				
F= 35657.	HZ	B/A= 16.7999	DB	PHI=-102.2	DEG
6.91825	V/GAMMA				
F= 40960.	HZ	B/A= 16.2001	DB	PHI= 158.3	DEG
6.4566	V/GAMMA				
F= 47051.	HZ	B/A= 10	DB	PHI= 119.7	DEG
3.16228	V/GAMMA				
F= 54047.	HZ	B/A= 4.79993	DB	PHI= 94.1	DEG
1.73779	V/GAMMA				
F= 62084.	HZ	B/A=-.500031	DB	PHI= 73.1	DEG
.944057	V/GAMMA				
F= 71316.	HZ	B/A=-4.79968	DB	PHI= 63.6	DEG
.575461	V/GAMMA				

VLF 33
CAL EXT (Suite)

31

A(V/γ)

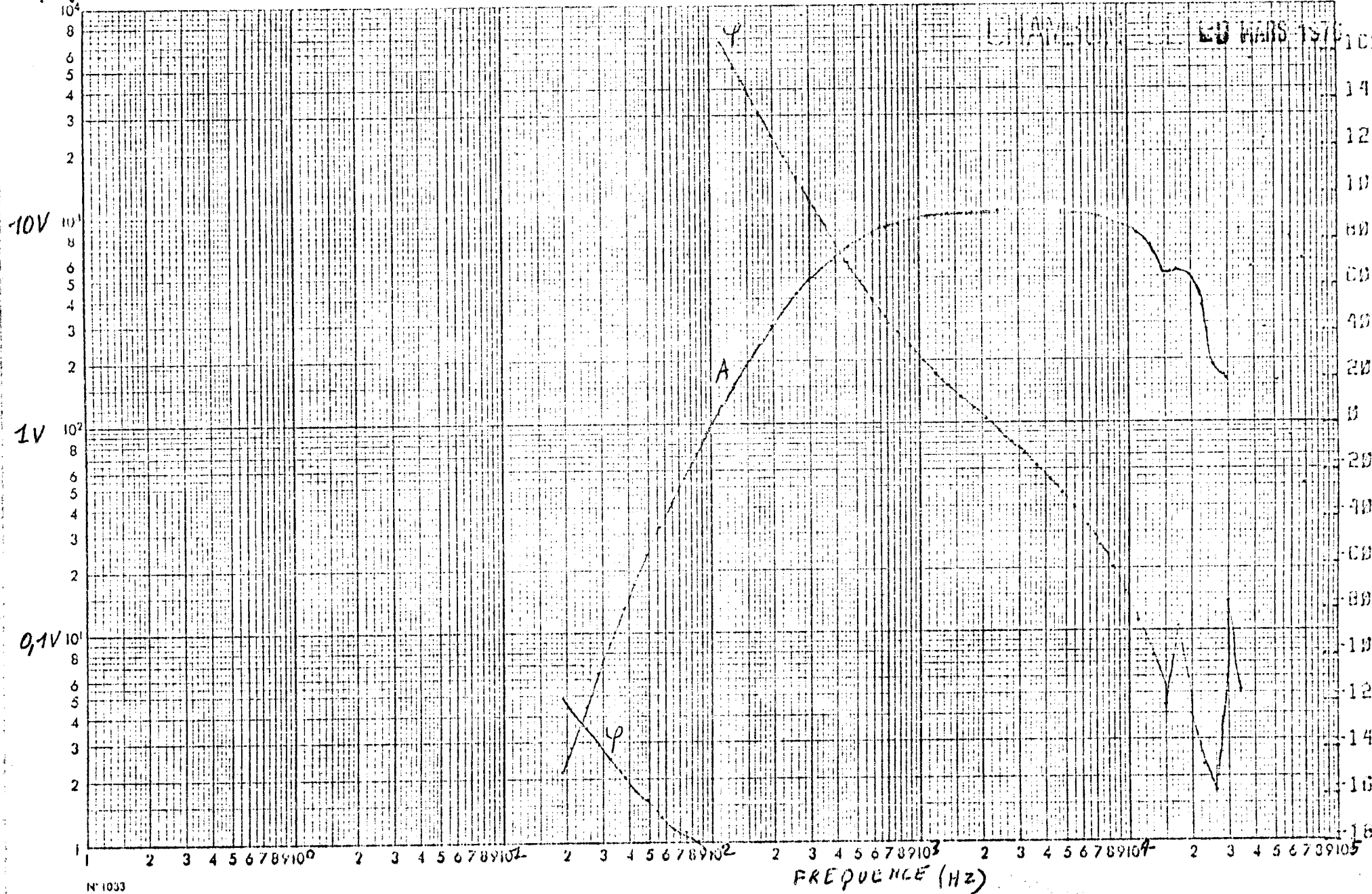

N° 1033

CAL EXT FN TRFT VLF NO 34 KER

N° 00100

UNIVERSITY OF MARYLAND

1

VLFF	VLFF	VLFF	VLFF	DEG
F= 20 HZ	B/A=-33.1	DB	PHI=-116.8	DEG
2.21313E-02	V/GAMMA			
F= 22 HZ	B/A=-30.7999	DB	PHI=-121.9	DEG
2.83435E-02	V/GAMMA			
F= 26 HZ	B/A=-26.8998	DB	PHI=-130.2	DEG
4.51867E-02	V/GAMMA			
F= 30 HZ	B/A=-23.7002	DB	PHI=-137.4	DEG
6.53116E-02	V/GAMMA			
F= 34 HZ	B/A=-23.9001	DB	PHI=-143.7	DEG
9.01565E-02	V/GAMMA			
F= 40 HZ	B/A=-17.5	DB	PHI=-151.508	DEG
.133352	V/GAMMA			
F= 45 HZ	B/A=-15.2001	DB	PHI=-157.7	DEG
.173779	V/GAMMA			
F= 52 HZ	B/A=-12.2999	DB	PHI=-161.008	DEG
.242663	V/GAMMA			
F= 60 HZ	B/A=-9.59998	DB	PHI=-168.6	DEG
.331132	V/GAMMA			
F= 69 HZ	B/A=-7.29968	DB	PHI=-173.8	DEG
.431535	V/GAMMA			
F= 79 HZ	B/A=-5.00024	DB	PHI=-174.6	DEG
.562325	V/GAMMA			
F= 91 HZ	B/A=-2.7002	DB	PHI=-178.6	DEG
.732333	V/GAMMA			
F= 105 HZ	B/A=-.299942	DB	PHI=-184.1	DEG
.966257	V/GAMMA			
F= 121 HZ	B/A= 1.90002	DB	PHI= 165.1	DEG
1.24452	V/GAMMA			
F= 139 HZ	B/A= 4 DB	PHI= 154	DEG	
1.53459	V/GAMMA			
F= 159 HZ	B/A= 5.79993	DB	PHI= 144.8	DEG
1.94983	V/GAMMA			
F= 180 HZ	B/A= 7.70007	DB	PHI= 134.6	DEG
2.42663	V/GAMMA			
F= 211 HZ	B/A= 9.59998	DB	PHI= 125	DEG
3.01994	V/GAMMA			
F= 242 HZ	B/A= 11.2001	DB	PHI= 116.2	DEG
3.63381	V/GAMMA			
F= 273 HZ	B/A= 12.7001	DB	PHI= 107	DEG
4.31523	V/GAMMA			
F= 319 HZ	B/A= 14 DB	PHI= 97.6	DEG	
5.01133	V/GAMMA			
F= 367 HZ	B/A= 15.2001	DB	PHI= 88.4	DEG
5.75445	V/GAMMA			
F= 422 HZ	B/A= 16.2001	DB	PHI= 79	DEG
6.4556	V/GAMMA			
F= 485 HZ	B/A= 17.1	DB	PHI= 70.4	DEG
7.16141	V/GAMMA			
F= 557 HZ	B/A= 17.9	DB	PHI= 62.2001	DEG
7.85238	V/GAMMA			
F= 639 HZ	B/A= 18.5	DB	PHI= 54.5	DEG
8.41395	V/GAMMA			
F= 735 HZ	B/A= 19 DB	PHI= 47.1	DEG	
8.91251	V/GAMMA			
F= 844 HZ	B/A= 19.4	DB	PHI= 40.2001	DEG
9.33257	V/GAMMA			
F= 970 HZ	B/A= 19.7001	DB	PHI= 33.7999	DEG
9.66359	V/GAMMA			
F= 1114 HZ	B/A= 20 DB	PHI= 27.7999	DEG	
10.	V/GAMMA			

VLFF N^o 34
CAL EXT
39 MARS 10
CHAMP 15

N^o 0010

F= 1279	HZ B/A= 20.1	DB	PHI= 22.2001	DEG	VLFN ₂ 34
10.1158	V/GAMMA				
F= 1470	HZ B/A= 20.2999	DB	PHI= 16.9	DEG	<AL EXT (SUITE)
10.3513	V/GAMMA				
F= 1688	HZ B/A= 20.2999	DB	PHI= 11.9	DEG	
10.3513	V/GAMMA				
F= 1940	HZ B/A= 20.4	DB	PHI= 6.90002	DEG	
10.4713	V/GAMMA				
F= 2228	HZ B/A= 20.5	DB	PHI= 2.09998	DEG	
10.5925	V/GAMMA				
F= 2559	HZ B/A= 20.6	DB	PHI=-2.6001	DEG	
10.7152	V/GAMMA				
F= 2940	HZ B/A= 20.6	DB	PHI=-7.50024	DEG	
10.7152	V/GAMMA				
F= 3377	HZ B/A= 20.6	DB	PHI=-12.5005	DEG	
10.7152	V/GAMMA				
F= 3880	HZ B/A= 20.6	DB	PHI=-17.7999	DEG	
10.7152	V/GAMMA				
F= 4457	HZ B/A= 20.6	DB	PHI=-23.501	DEG	
10.7152	V/GAMMA				
F= 5119	HZ B/A= 20.5	DB	PHI=-29.6	DEG	
10.5925	V/GAMMA				
F= 5881	HZ B/A= 20.2999	DB	PHI=-36.2999	DEG	
10.3513	V/GAMMA				
F= 6755	HZ B/A= 20.2001	DB	PHI=-43.7001	DEG	
10.233	V/GAMMA				
F= 7760	HZ B/A= 19.9	DB	PHI=-52.1	DEG	
9.88556	V/GAMMA				
F= 8914	HZ B/A= 19.6	DB	PHI=-61.502	DEG	
9.5499	V/GAMMA				
F= 10240	HZ B/A= 19.1	DB	PHI=-72.2999	DEG	
9.01569	V/GAMMA				
F= 11762	HZ B/A= 18.4	DB	PHI=-84.9	DEG	
8.31766	V/GAMMA				
F= 13511	HZ B/A= 17.2999	DB	PHI=-100.1	DEG	
7.32818	V/GAMMA				
F= 15520	HZ B/A= 14.5	DB	PHI=-121.8	DEG	
5.30834	V/GAMMA				
F= 17828	HZ B/A= 14.7999	DB	PHI=-87.5039	DEG	
5.49536	V/GAMMA				
F= 20480	HZ B/A= 14.4	DB	PHI=-125.7	DEG	
5.24809	V/GAMMA				
F= 23525	HZ B/A= 11.4	DB	PHI=-147.3	DEG	
3.71536	V/GAMMA				
F= 27023	HZ B/A= 5.40002	DB	PHI=-158.6	DEG	
1.86209	V/GAMMA				
F= 31042	HZ B/A= 4.29993	DB	PHI=-76.7999	DEG	
1.64058	V/GAMMA				
F= 35657.	HZ B/A= 18.7001	DB	PHI=-115.4	DEG	
8.61001	V/GAMMA				
F= 40960.	HZ B/A= 15.1	DB	PHI= 156.7	DEG	
5.68851	V/GAMMA				
F= 47051.	HZ B/A= 9.20007	DB	PHI= 122.8	DEG	
2.88406	V/GAMMA				
F= 54047.	HZ B/A= 4.09998	DB	PHI= 99.1	DEG	
1.60324	V/GAMMA				
F= 62084.	HZ B/A=-1.20013	DB	PHI= 80.6	DEG	
.87095	V/GAMMA				
F= 71316.	HZ B/A=-5.69983	DB	PHI= 71.2999	DEG	
.51881	V/GAMMA				

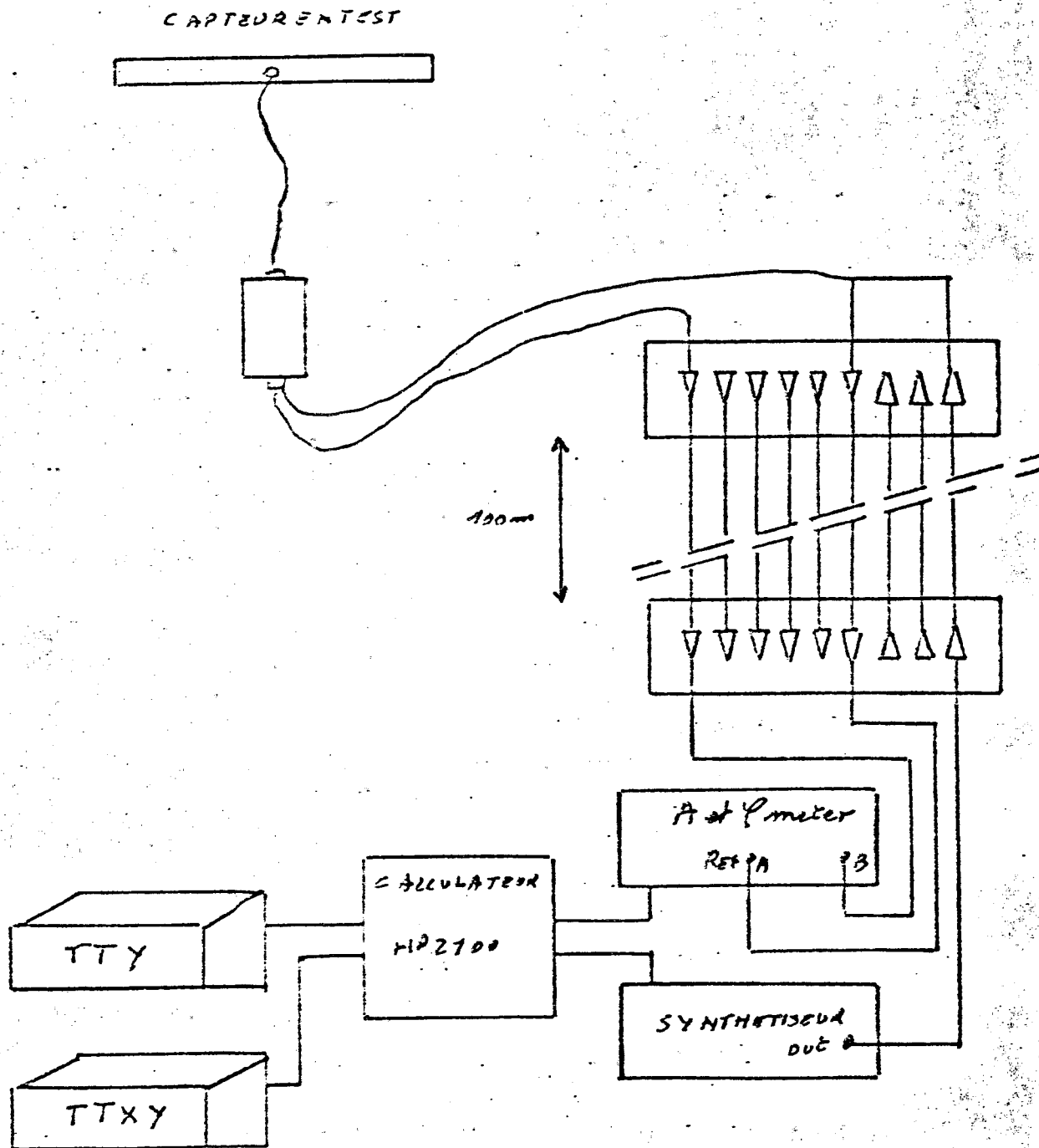

Repère	N° plan	Nbre	Désignation	Matière
CREE	CENTRE DE RECHERCHE EN PHYSIQUE DE L'ENVIRONNEMENT			Date: 21 JUN 76
				Dessiné: F.X. SENE
			MAGNETOMETRE SOL	Echelle: <i>OR</i> CNET
			CALIBRATION INTERNE (MEASURE)	
				NO 34

A(V/V)

35

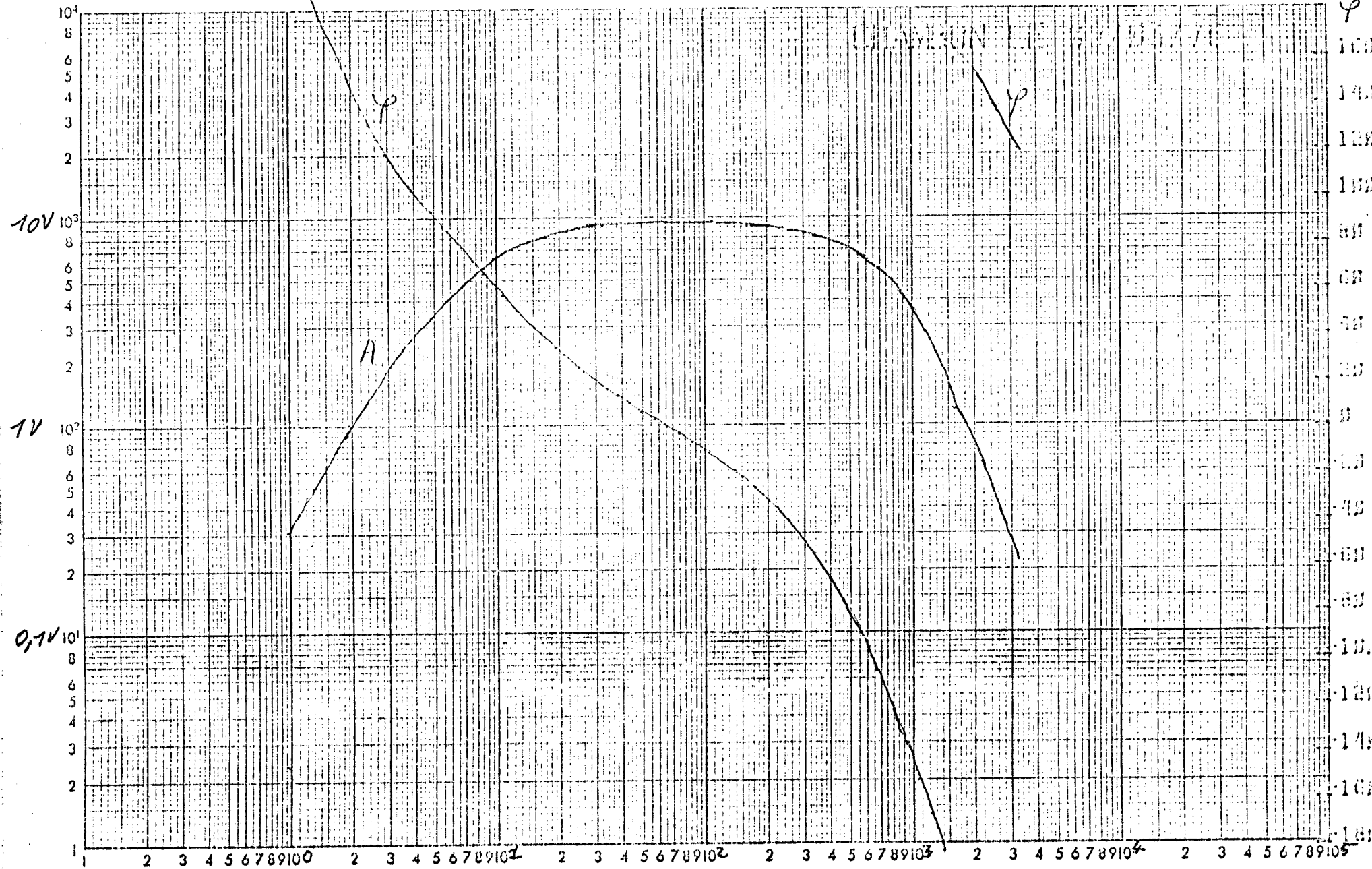

CAMBRON L.F. 10071

N° 1033

CAL INT FN TRFT ELF NO 30

FREQUENCY (Hz)

00110

0011

09 MARS 1976

ELF 30

CAL INT

FRUN	ELF	ELF	ELF	ELF
F= 1	HZ	B/A=-13.8225	DB	PHI=-145.3 DEG
.31621		V/V		
F= 2	HZ	B/A= .232373	DB	PHI= 153.9 DEG
1.82233		V/V		
F= 3	HZ	B/A= 5.42222	DB	PHI= 118.2 DEG
1.86209		V/V		
F= 4	HZ	B/A= 8.5	DB	PHI= 103 DEG
2.66073		V/V		
F= 5	HZ	B/A= 13.6	DB	PHI= 93.6 DEG
3.38843		V/V		
F= 6	HZ	B/A= 12.2999	DB	PHI= 84.7999 DEG
4.12094		V/V		
F= 7	HZ	B/A= 13.6	DB	PHI= 77.9 DEG
4.78629		V/V		
F= 8	HZ	B/A= 14.5	DB	PHI= 71.9 DEG
5.30884		V/V		
F= 9	HZ	B/A= 15.2999	DB	PHI= 66.5 DEG
5.82098		V/V		
F= 10	HZ	B/A= 16.4	DB	PHI= 62.6 DEG
6.60696		V/V		
F= 11	HZ	B/A= 16.7301	DB	PHI= 57.4 DEG
6.83917		V/V		
F= 13	HZ	B/A= 17.4	DB	PHI= 53.5 DEG
7.41313		V/V		
F= 15	HZ	B/A= 17.9	DB	PHI= 44.9 DEG
7.35233		V/V		
F= 17	HZ	B/A= 18.2301	DB	PHI= 41.1 DEG
8.12337		V/V		
F= 20	HZ	B/A= 18.6	DB	PHI= 34.2999 DEG
8.51136		V/V		
F= 22	HZ	B/A= 18.7999	DB	PHI= 31 DEG
8.70956		V/V		
F= 26	HZ	B/A= 19.1	DB	PHI= 25.7999 DEG
9.01569		V/V		
F= 30	HZ	B/A= 19.2999	DB	PHI= 21.4 DEG
9.22564		V/V		
F= 34	HZ	B/A= 19.4	DB	PHI= 17.6 DEG
9.33257		V/V		
F= 40	HZ	B/A= 19.5	DB	PHI= 13.2301 DEG
9.44061		V/V		
F= 45	HZ	B/A= 19.6	DB	PHI= 13.2301 DEG
9.5499		V/V		
F= 52	HZ	B/A= 19.6	DB	PHI= 6.09998 DEG
9.5499		V/V		
F= 60	HZ	B/A= 19.7301	DB	PHI= 3.09998 DEG
9.66059		V/V		
F= 69	HZ	B/A= 19.7301	DB	PHI=-.200081 DEG
9.66059		V/V		
F= 79	HZ	B/A= 19.7301	DB	PHI=-3.30005 DEG
9.66059		V/V		

F= 91	HZ	B/A= 19.7001	DB	PHI=-6.79968	DEG
9.56059	V/V				
F= 105	HZ	B/A= 19.7001	DB	PHI=-10.4	DEG
9.56359	V/V				
F= 121	HZ	B/A= 19.6	DB	PHI=-14.1	DEG
9.5499	V/V				
F= 139	HZ	B/A= 19.6	DB	PHI=-18.1	DEG
9.5499	V/V				
F= 159	HZ	B/A= 19.5	DB	PHI=-22.1	DEG
9.44061	V/V				
F= 183	HZ	B/A= 19.4	DB	PHI=-26.7001	DEG
9.33257	V/V				
F= 211	HZ	B/A= 19.2001	DB	PHI=-31.7999	DEG
9.12319	V/V				
F= 242	HZ	B/A= 19.1	DB	PHI=-37.2001	DEG
9.01569	V/V				
F= 273	HZ	B/A= 18.9	DB	PHI=-43.2999	DEG
8.81052	V/V				
F= 319	HZ	B/A= 18.6	DB	PHI=-49.9	DEG
8.51136	V/V				
F= 367	HZ	B/A= 18.2999	DB	PHI=-57.502	DEG
8.22236	V/V				
F= 422	HZ	B/A= 17.9	DB	PHI=-65.7999	DEG
7.85238	V/V				
F= 485	HZ	B/A= 17.5	DB	PHI=-75.2001	DEG
7.49394	V/V				
F= 557	HZ	B/A= 16.9	DB	PHI=-85.5039	DEG
6.99844	V/V				
F= 639	HZ	B/A= 16.1	DB	PHI=-96.7999	DEG
6.63262	V/V				
F= 735	HZ	B/A= 15.2001	DB	PHI=-109.4	DEG
6.25445	V/V				
F= 844	HZ	B/A= 14	DB	PHI=-123.004	DEG
5.81188	V/V				
F= 973	HZ	B/A= 12.5	DB	PHI=-137.4	DEG
4.21697	V/V				
F= 1114	HZ	B/A= 10.6	DB	PHI=-152.1	DEG
3.38343	V/V				
F= 1279	HZ	B/A= 8.29993	DB	PHI=-167.008	DEG
2.60014	V/V				
F= 1473	HZ	B/A= 5.70007	DB	PHI=-182.3	DEG
1.92754	V/V				
F= 1633	HZ	B/A= 1.59993	DB	PHI= 158.9	DEG
1.20226	V/V				
F= 1940	HZ	B/A= .400024	DB	PHI= 170.2	DEG
1.04713	V/V				
F= 2223	HZ	B/A=-2.6001	DB	PHI= 152.2	DEG
.741302	V/V				
F= 2559	HZ	B/A=-5.69983	DB	PHI= 139.1	DEG
.51831	V/V				
F= 2940	HZ	B/A=-9.39998	DB	PHI= 130.4	DEG
.350753	V/V				
F= 3377	HZ	B/A=-12.4	DB	PHI= 120.3	DEG
.239383	V/V				

ELF 30

CAL INT(SOITE)

READY

38

A (V/V)

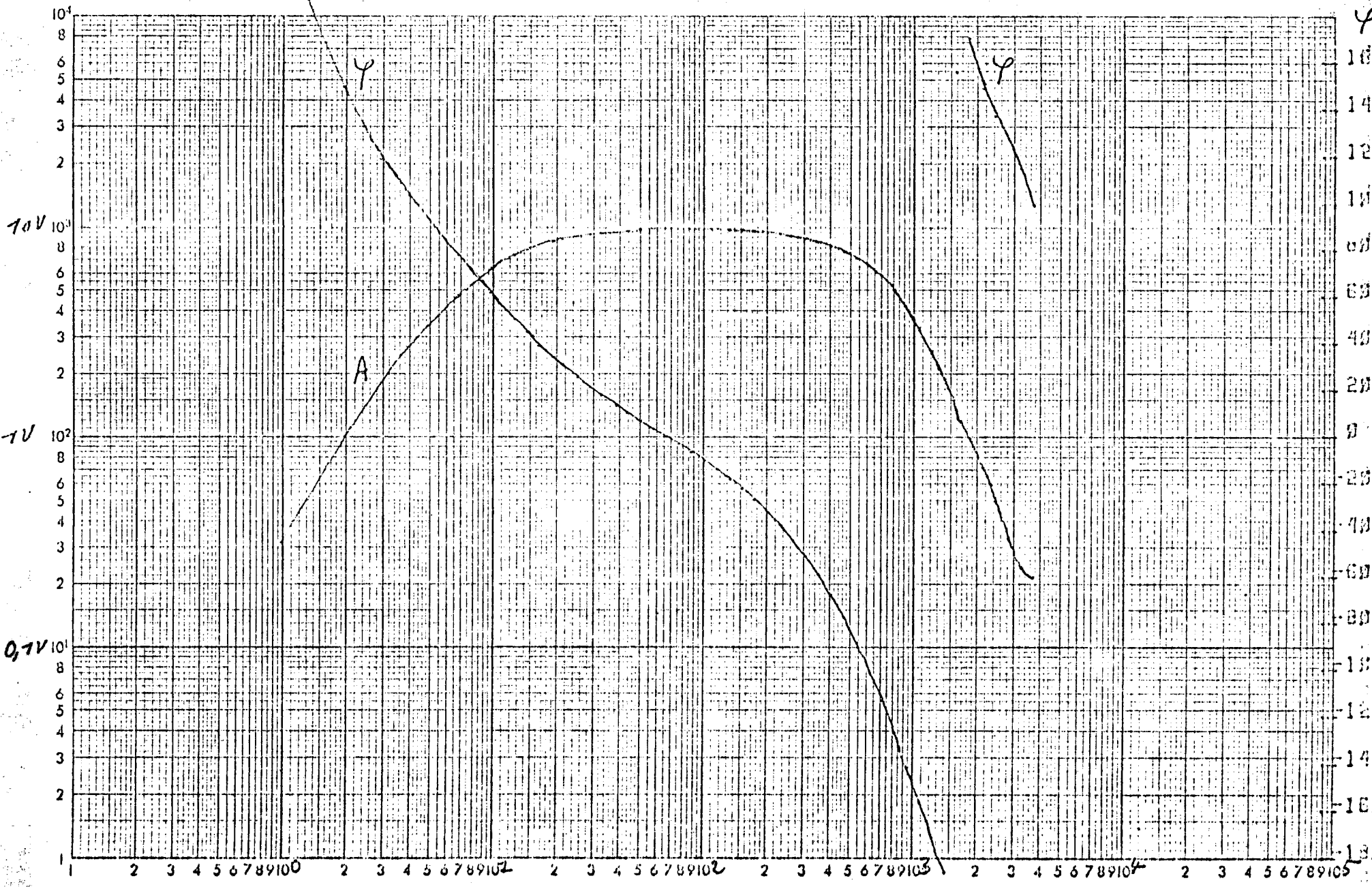

N 1033

CAL INT EN TRET ELF NO 31

FREQUENCE (Hz)

10 001 07

00107

6 MAR 1971

ELF 37

CAL INT

ELF		ELF		ELF		
F= 1	HZ	B/A=-9.79993	DB	PHI=-142.1	DEG	
.323596		V/V				
F= 2	HZ	B/A= 9.99756E-02	DB	PHI= 153.1	DEG	
1.31158		V/V				
F= 3	HZ	B/A= 5.29993	DB	PHI= 119.4	DEG	
1.34076		V/V				
F= 4	HZ	B/A= 8.73007	DB	PHI= 104	DEG	
2.72272		V/V				
F= 5	HZ	B/A= 10.7301	DB	PHI= 94.9	DEG	
3.42771		V/V				
F= 6	HZ	B/A= 12.4	DB	PHI= 85.2999	DEG	
4.16871		V/V				
F= 7	HZ	B/A= 13.6	DB	PHI= 78.4	DEG	
4.78629		V/V				
F= 8	HZ	B/A= 14.6	DB	PHI= 72.2999	DEG	
5.3703		V/V				
F= 9	HZ	B/A= 15.4	DB	PHI= 67.2001	DEG	
5.38845		V/V				
F= 10	HZ	B/A= 16.4	DB	PHI= 62.4	DEG	
6.60696		V/V				
F= 11	HZ	B/A= 16.7001	DB	PHI= 57.7999	DEG	
6.33917		V/V				
F= 13	HZ	B/A= 17.4	DB	PHI= 50.7999	DEG	
7.41313		V/V				
F= 15	HZ	B/A= 17.9	DB	PHI= 45.5	DEG	
7.35238		V/V				
F= 17	HZ	B/A= 18.4	DB	PHI= 39.4	DEG	
8.31766		V/V				
F= 20	HZ	B/A= 18.7001	DB	PHI= 34.5	DEG	
8.61001		V/V				
F= 22	HZ	B/A= 18.9	DB	PHI= 31.4	DEG	
8.31052		V/V				
F= 26	HZ	B/A= 19.2001	DB	PHI= 26.1	DEG	
9.12019		V/V				
F= 30	HZ	B/A= 19.4	DB	PHI= 21.7999	DEG	
9.33257		V/V				
F= 34	HZ	B/A= 19.5	DB	PHI= 18.2001	DEG	
9.44061		V/V				
F= 40	HZ	B/A= 19.6	DB	PHI= 13.7001	DEG	
9.5499		V/V				
F= 45	HZ	B/A= 19.7001	DB	PHI= 10.6	DEG	
9.66059		V/V				
F= 52	HZ	B/A= 19.9	DB	PHI= 7.29993	DEG	
9.33556		V/V				
F= 60	HZ	B/A= 19.9	DB	PHI= 3.5	DEG	
9.38556		V/V				
F= 69	HZ	B/A= 19.9	DB	PHI= .200073	DEG	
9.38556		V/V				
F= 79	HZ	B/A= 19.9	DB	PHI=-2.90015	DEG	
9.33556		V/V				
F= 91	HZ	B/A= 19.9	DB	PHI=-6.39973	DEG	
9.33556		V/V				

F= 105 HZ	B/A= 19.9	DB	PHI=-10.0005	DEG
9.88556	V/V			
F= 121 HZ	B/A= 19.9	DB	PHI=-13.7999	DEG
9.38556	V/V			
F= 139 HZ	B/A= 19.7999	DB	PHI=-17.7999	DEG
9.77229	V/V			
F= 159 HZ	B/A= 19.7999	DB	PHI=-21.9	DEG
9.77229	V/V			
F= 183 HZ	B/A= 19.7001	DB	PHI=-26.6	DEG
9.66059	V/V			
F= 211 HZ	B/A= 19.5	DB	PHI=-31.7999	DEG
9.44061	V/V			
F= 242 HZ	B/A= 19.4	DB	PHI=-37.4	DEG
9.33257	V/V			
F= 278 HZ	B/A= 19.2001	DB	PHI=-43.7001	DEG
9.12019	V/V			
F= 319 HZ	B/A= 18.9	DB	PHI=-50.7001	DEG
8.81052	V/V			
F= 367 HZ	B/A= 18.6	DB	PHI=-58.6	DEG
8.51135	V/V			
F= 422 HZ	B/A= 18.2001	DB	PHI=-67.4	DEG
8.12837	V/V			
F= 485 HZ	B/A= 17.7001	DB	PHI=-77.1	DEG
7.67363	V/V			
F= 557 HZ	B/A= 17.1	DB	PHI=-87.9	DEG
7.16141	V/V			
F= 639 HZ	B/A= 16.4	DB	PHI=-99.7999	DEG
6.60696	V/V			
F= 735 HZ	B/A= 15.4	DB	PHI=-112.8	DEG
5.88845	V/V			
F= 844 HZ	B/A= 14.1	DB	PHI=-126.7	DEG
5.06989	V/V			
F= 970 HZ	B/A= 12.5	DB	PHI=-141.3	DEG
4.21697	V/V			
F= 1114 HZ	B/A= 10.5	DB	PHI=-156.2	DEG
3.34966	V/V			
F= 1279 HZ	B/A= 8.20007	DB	PHI=-171.008	DEG
2.57042	V/V			
F= 1470 HZ	B/A= 5.5	DB	PHI=-186.008	DEG
1.83365	V/V			
F= 1683 HZ	B/A= 1.79993	DB	PHI= 156.2	DEG
1.23025	V/V			
F= 1940 HZ	B/A=-.200081	DB	PHI= 170.4	DEG
.977223	V/V			
F= 2228 HZ	B/A=-2.90015	DB	PHI= 149.1	DEG
.716131	V/V			
F= 2559 HZ	B/A=-6.09973	DB	PHI= 137.3	DEG
.495465	V/V			
F= 2940 HZ	B/A=-9.59998	DB	PHI= 127.7	DEG
.331132	V/V			
F= 3377 HZ	B/A=-12.4	DB	PHI= 115	DEG
.239883	V/V			
F= 3880 HZ	B/A=-13.2999	DB	PHI= 99.5	DEG
.216274	V/V			
F= 4457 HZ	B/A=-13.6	DB	PHI= 89.2001	DEG
.20893	V/V			

STOP

ELF 31

CAL INT (SCITE)

A (V/V)

41

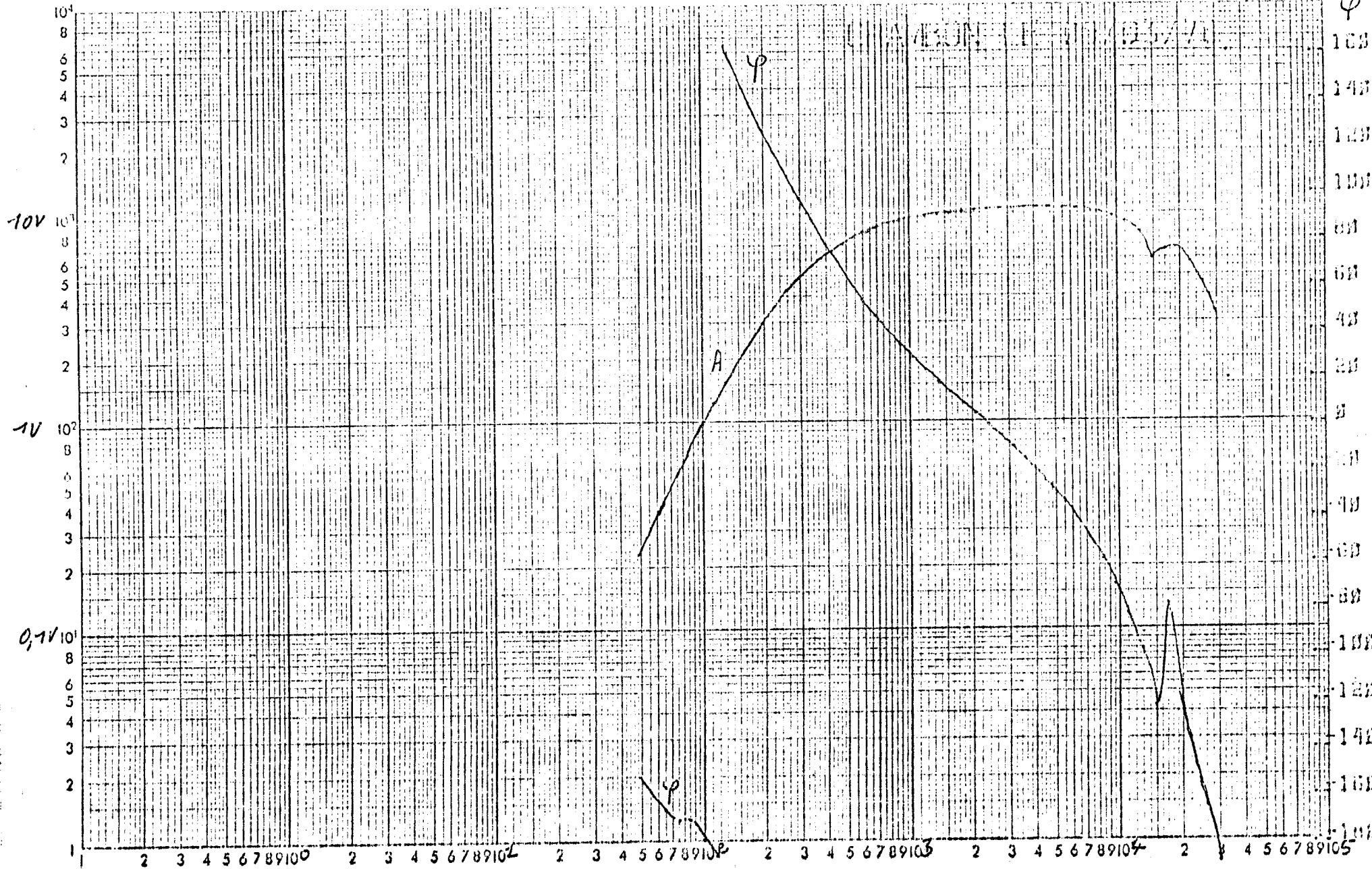

N° 1033

CAL INT FN TRFT VLF NO 32

FREQUENCY

N° UU106

VL F	VL F	VL F	VL F	VL F
F= 52 HZ .239883	B/A=-12.4 V/V	DB	PHI=-151.9	DEG
F= 60 HZ .319889	B/A=-9.90002 V/V	DB	PHI=-159.9	DEG
F= 69 HZ .421685	B/A=-7.50024 V/V	DB	PHI=-166.1	DEG
F= 80 HZ .568867	B/A=-4.89978 V/V	DB	PHI=-170.3	DEG
F= 91 HZ .741302	B/A=-2.6001 V/V	DB	PHI=-170.008	DEG
F= 105 HZ .988556	B/A=-9.99794E-02 V/V	DB	PHI=-178.1	DEG
F= 121 HZ 1.25893	B/A= 2 V/V	DB	PHI=-184.6	DEG
F= 139 HZ 1.53489	B/A= 4 V/V	DB	PHI= 163.5	DEG
F= 159 HZ 1.97243	B/A= 5.90002 V/V	DB	PHI= 151.3	DEG
F= 183 HZ 2.45469	B/A= 7.79993 V/V	DB	PHI= 139.3	DEG
F= 211 HZ 3.05495	B/A= 9.70007 V/V	DB	PHI= 127.6	DEG
F= 242 HZ 3.67279	B/A= 11.2999 V/V	DB	PHI= 117.2	DEG
F= 278 HZ 4.41572	B/A= 12.9 V/V	DB	PHI= 107.6	DEG
F= 319 HZ 5.06989	B/A= 14.1 V/V	DB	PHI= 98	DEG
F= 367 HZ 5.82098	B/A= 15.2999 V/V	DB	PHI= 88.2001	DEG
F= 422 HZ 6.53125	B/A= 16.2999 V/V	DB	PHI= 78.4	DEG
F= 485 HZ 7.16141	B/A= 17.1 V/V	DB	PHI= 69.9	DEG
F= 557 HZ 7.85238	B/A= 17.9 V/V	DB	PHI= 61.7999	DEG
F= 639 HZ 8.41395	B/A= 18.5 V/V	DB	PHI= 54.2999	DEG
F= 735 HZ 8.81052	B/A= 18.9 V/V	DB	PHI= 47	DEG
F= 844 HZ 9.22564	B/A= 19.2999 V/V	DB	PHI= 40.4	DEG
F= 970 HZ 9.5499	B/A= 19.6 V/V	DB	PHI= 34.2001	DEG
F= 1114 HZ 9.83556	B/A= 19.9 V/V	DB	PHI= 28.5	DEG
F= 1279 HZ 10.	B/A= 20 V/V	DB	PHI= 23.2001	DEG
F= 1470 HZ 10.1158	B/A= 20.1 V/V	DB	PHI= 18.1	DEG
F= 1688 HZ 10.233	B/A= 20.2001 V/V	DB	PHI= 13.2999	DEG
F= 1940 HZ 10.3513	B/A= 20.2999 V/V	DB	PHI= 8.59998	DEG

N^o 0010

-9 MARS

VL F 32

CAL INT

F	Unit	B/A	DB	PHI	DEG
10.5925	HZ	20.6	DB	PHI=-.40004	DEG
F= 2559	V/V				
10.7152	HZ	20.7001	DB	PHI=-5.00024	DEG
F= 2940	V/V				
10.8394	HZ	20.7001	DB	PHI=-9.90002	DEG
F= 3377	V/V				
10.8394	HZ	20.7999	DB	PHI=-15.0005	DEG
F= 3883	V/V				
10.9647	HZ	20.7999	DB	PHI=-20.501	DEG
F= 4457	V/V				
10.9647	HZ	20.7999	DB	PHI=-26.6	DEG
F= 5119	V/V				
10.9647	HZ	20.7001	DB	PHI=-33.4	DEG
F= 5881	V/V				
10.8394	HZ	20.6	DB	PHI=-40.9	DEG
F= 6755	V/V				
10.7152	HZ	20.5	DB	PHI=-49.4	DEG
F= 7760	V/V				
10.5925	HZ	20.2999	DB	PHI=-59.002	DEG
F= 8914	V/V				
10.3513	HZ	19.9	DB	PHI=-69.9	DEG
F= 10240	V/V				
9.83556	HZ	19.2999	DB	PHI=-82.6	DEG
F= 11762	V/V				
9.22564	HZ	18.4	DB	PHI=-98.2001	DEG
F= 13511	V/V				
8.31766	HZ	15.7001	DB	PHI=-122.004	DEG
F= 15520	V/V				
6.09542	HZ	16.6	DB	PHI=-78.2001	DEG
F= 17823	V/V				
6.76031	HZ	16.9	DB	PHI=-119.9	DEG
F= 20430	V/V				
6.99344	HZ	15.4	DB	PHI=-143.008	DEG
F= 23525	V/V				
5.88845	HZ	13.5	DB	PHI=-164.7	DEG
F= 27023	V/V				
4.73151	HZ	10.7001	DB	PHI=-187.6	DEG
F= 31042	V/V				
3.42771	HZ	4.20007	DB	PHI= 160.6	DEG
F= 35657.	V/V				
1.62182	HZ	7.09998	DB	PHI= 155.1	DEG
F= 40960.	V/V				
2.26464	HZ	4	DB	PHI= 126.8	DEG
F= 47051.	V/V				
1.58489	HZ	.200073	DB	PHI= 104.6	DEG
F= 54047.	V/V				
1.0233	HZ	-4.29968	DB	PHI= 84.9	DEG
F= 62034.	V/V				
.609559	HZ	-7.50024	DB	PHI= 72.9	DEG
F= 71316.	V/V				
.421685					

CAL INT (3078)

A(V/V)

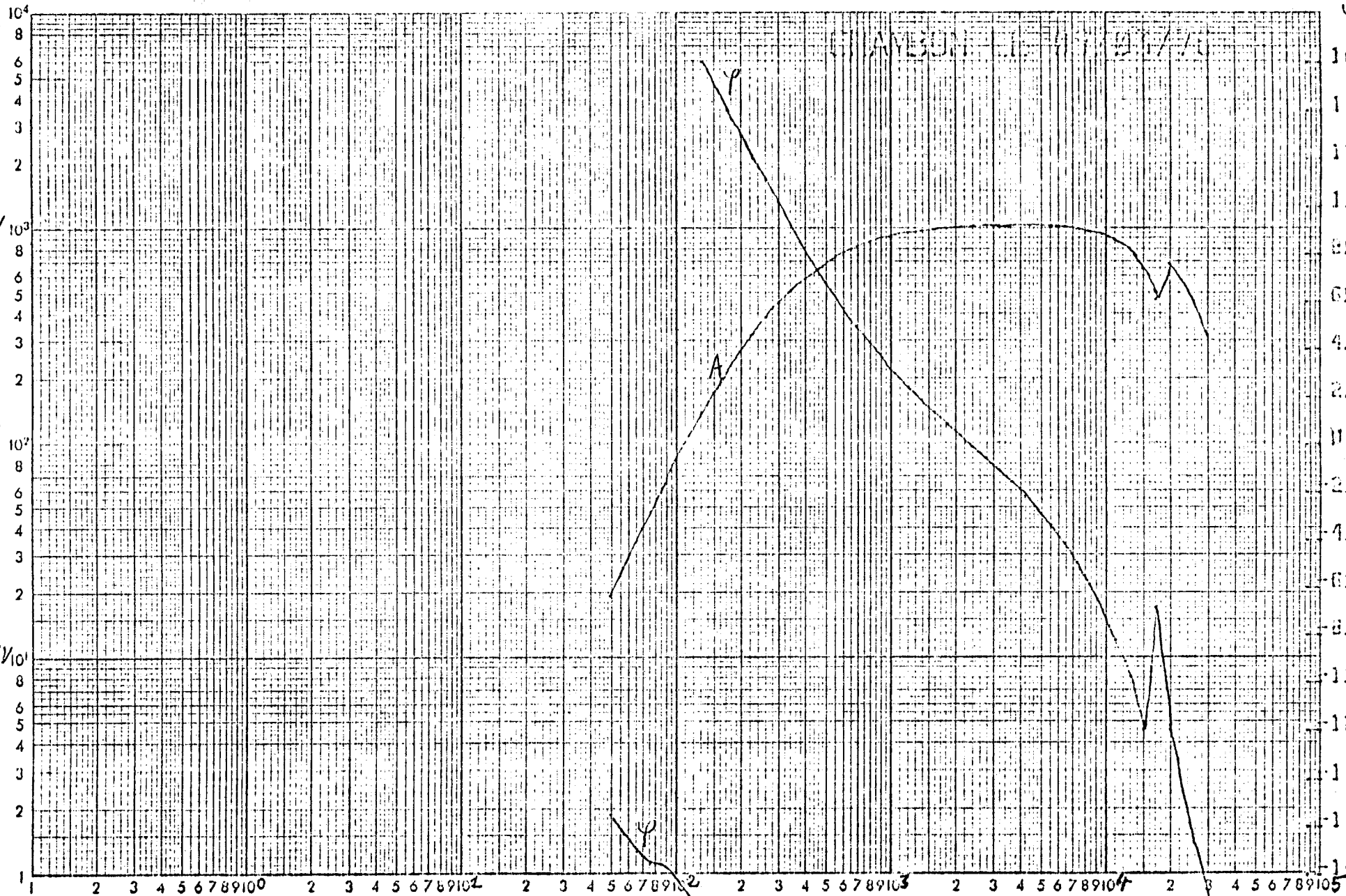

44

N° 1033

CAL INT EN TRET MLE MA 33

FREQUENCE (Hz)

10 00 1 00

VLF	VLF	VLF			
F= 52 HZ .199515	B/A=-14.2335 V/V	DB	PHI=-154.4		DEG
F= 63 HZ .269153	B/A=-11.4 V/V	DB	PHI=-162.538		DEG
F= 69 HZ .353921	B/A=-8.93332 V/V	DB	PHI=-169.9		DEG
F= 83 HZ .489788	B/A=-6.19933 V/V	DB	PHI=-174.538		DEG
F= 91 HZ .63094	B/A=-4.23324 V/V	DB	PHI=-174.9		DEG
F= 105 HZ .85113	B/A=-1.43339 V/V	DB	PHI=-183.4		DEG
F= 121 HZ 1.10918	B/A= .933324 V/V	DB	PHI=-189.2		DEG
F= 139 HZ 1.41254	B/A= 3 V/V	DB	PHI= 160.4		DEG
F= 159 HZ 1.75793	B/A= 4.93332 V/V	DB	PHI= 150.2		DEG
F= 183 HZ 2.18774	B/A= 6.79993 V/V	DB	PHI= 140.4		DEG
F= 211 HZ 2.72272	B/A= 8.73337 V/V	DB	PHI= 130.1		DEG
F= 242 HZ 3.31132	B/A= 10.4 V/V	DB	PHI= 120.3		DEG
F= 273 HZ 3.93107	B/A= 12 V/V	DB	PHI= 111.4		DEG
F= 319 HZ 4.62377	B/A= 13.2999 V/V	DB	PHI= 101.9		DEG
F= 367 HZ 5.33384	B/A= 14.5 V/V	DB	PHI= 92.4		DEG
F= 422 HZ 6.02558	B/A= 15.6 V/V	DB	PHI= 82.7999		DEG
F= 485 HZ 6.63344	B/A= 16.5 V/V	DB	PHI= 74		DEG
F= 557 HZ 7.32318	B/A= 17.2999 V/V	DB	PHI= 65.6		DEG
F= 639 HZ 7.94328	B/A= 18 V/V	DB	PHI= 57.7001		DEG
F= 735 HZ 8.51136	B/A= 18.6 V/V	DB	PHI= 50.2331		DEG
F= 844 HZ 8.91251	B/A= 19 V/V	DB	PHI= 43.1		DEG
F= 970 HZ 9.33257	B/A= 19.4 V/V	DB	PHI= 36.4		DEG
F= 1114 HZ 9.5499	B/A= 19.6 V/V	DB	PHI= 30.2999		DEG
F= 1279 HZ 9.77229	B/A= 19.7999 V/V	DB	PHI= 24.6		DEG
F= 1470 HZ 10.	B/A= 23 V/V	DB	PHI= 19.1		DEG
F= 1688 HZ 10.1158	B/A= 23.1 V/V	DB	PHI= 14		DEG
F= 1940 HZ 10.233	B/A= 23.2001 V/V	DB	PHI= 9		DEG

29 MARS 1976
 200103
 VLF 33
 CAL INT

F= 2228	HZ	B/A= 20.2999	DB	PHI= 4.20007	DEG	
10.3513	V/V					
F= 2559	HZ	B/A= 20.4	DB	PHI=-.600006	DEG	VLF 33
10.4713	V/V					
F= 2940	HZ	B/A= 20.5	DB	PHI=-5.39978	DEG	CAL INT (SMT)
10.5925	V/V					
F= 3377	HZ	B/A= 20.5	DB	PHI=-10.2999	DEG	
10.5925	V/V					
F= 3880	HZ	B/A= 20.5	DB	PHI=-15.6	DEG	
10.5925	V/V					
F= 4457	HZ	B/A= 20.5	DB	PHI=-21.2001	DEG	
10.5925	V/V					
F= 5119	HZ	B/A= 20.5	DB	PHI=-27.2001	DEG	
10.5925	V/V					
F= 5881	HZ	B/A= 20.4	DB	PHI=-33.7999	DEG	
10.4713	V/V					
F= 6755	HZ	B/A= 20.2999	DB	PHI=-41.1	DEG	
10.3513	V/V					
F= 7760	HZ	B/A= 20.1	DB	PHI=-49.4	DEG	
10.1158	V/V					
F= 8914	HZ	B/A= 19.9	DB	PHI=-58.7001	DEG	
9.88556	V/V					
F= 10240	HZ	B/A= 19.6	DB	PHI=-69.5039	DEG	
9.5499	V/V					
F= 11762	HZ	B/A= 19.1	DB	PHI=-82.0039	DEG	
9.01569	V/V					
F= 13511	HZ	B/A= 18.2999	DB	PHI=-97.2001	DEG	
8.22236	V/V					
F= 15520	HZ	B/A= 16.4	DB	PHI=-119.3	DEG	
6.60696	V/V					
F= 17828	HZ	B/A= 13.6	DB	PHI=-68.1	DEG	
4.78629	V/V					
F= 20480	HZ	B/A= 16.9	DB	PHI=-119.504	DEG	
6.99844	V/V					
F= 23525	HZ	B/A= 15.4	DB	PHI=-145.2	DEG	
5.88845	V/V					
F= 27023	HZ	B/A= 13.4	DB	PHI=-168.2	DEG	
4.67737	V/V					
F= 31042	HZ	B/A= 10.4	DB	PHI=-192.008	DEG	
3.31132	V/V					
F= 35657.	HZ	B/A= 3.59998	DB	PHI= 157.4	DEG	
1.51356	V/V					
F= 40960.	HZ	B/A= 6.70007	DB	PHI= 152.3	DEG	
2.16274	V/V					
F= 47051.	HZ	B/A= 3.59998	DB	PHI= 122.2	DEG	
1.51356	V/V					
F= 54047.	HZ	B/A=-.40004	DB	PHI= 99.4	DEG	
.954989	V/V					
F= 62084.	HZ	B/A=-5.09973	DB	PHI= 80	DEG	
.555921	V/V					
F= 71316.	HZ	B/A=-8.29993	DB	PHI= 69.2001	DEG	
.384595	V/V					

DEADY

A(V/V)

47

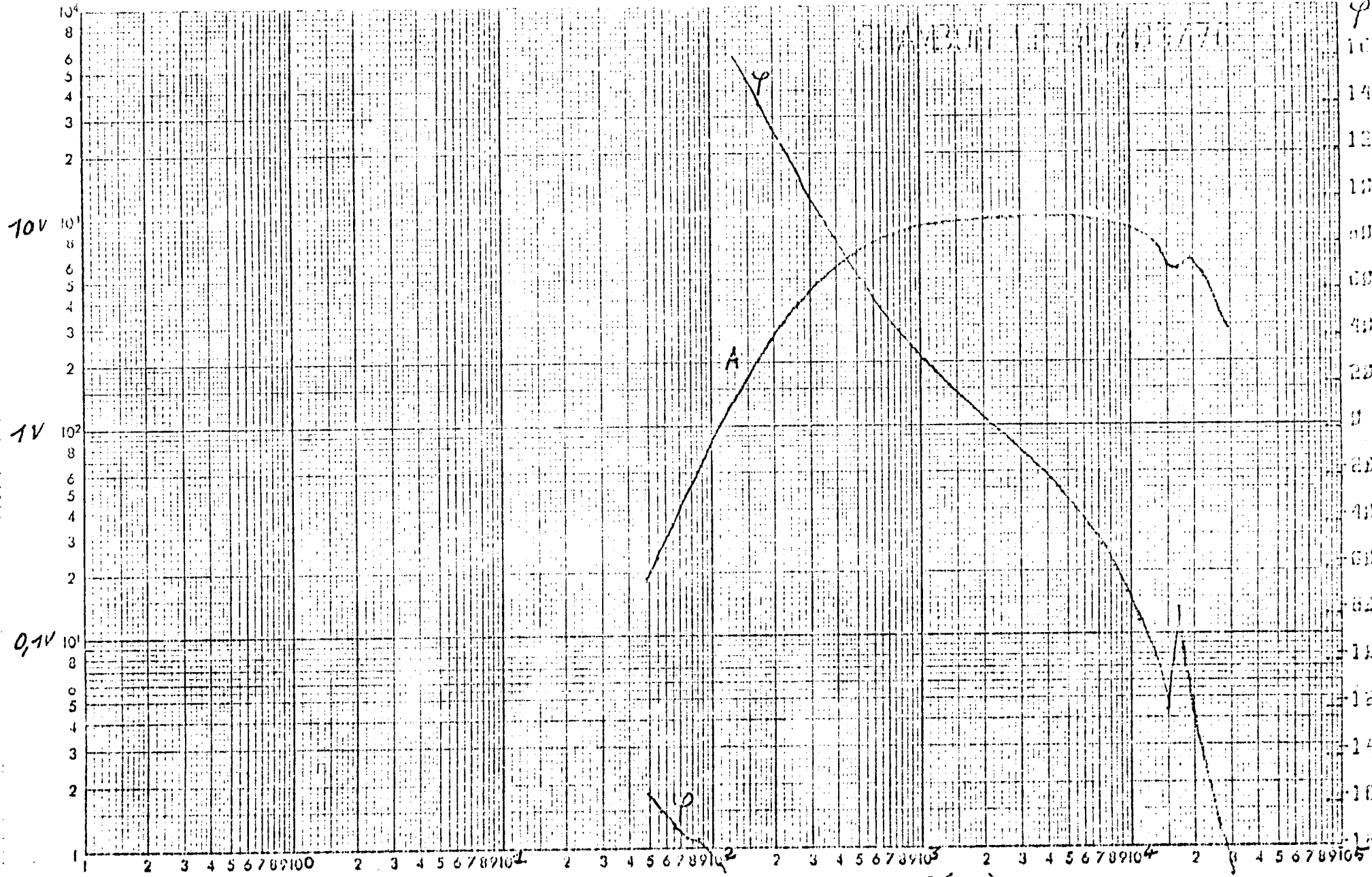

N° 1033

CAL INT FN TRFT VLF N° 34

N° 00102

VLF		VLF		VLF			
F= 52	HZ	B/A=-14.1		DB	PHI=-155.2	DEG	
.197243		V/V					
F= 60	HZ	B/A=-11.4		DB	PHI=-163.008	DEG	
.269153		V/V					
F= 69	HZ	B/A=-8.79993		DB	PHI=-170.008	DEG	
.363081		V/V					
F= 80	HZ	B/A=-6.19983		DB	PHI=-174.1	DEG	
.489783		V/V					
F= 91	HZ	B/A=-4.00024		DB	PHI=-174.2	DEG	
.63094		V/V					
F= 105	HZ	B/A=-1.50006		DB	PHI=-180.008	DEG	
.841389		V/V					
F= 121	HZ	B/A= .799927		DB	PHI=-188.3	DEG	
1.09647		V/V					
F= 139	HZ	B/A= 2.90002		DB	PHI= 160.3	DEG	
1.39637		V/V					
F= 159	HZ	B/A= 4.79993		DB	PHI= 150.7	DEG	
1.73779		V/V					
F= 183	HZ	B/A= 6.70007		DB	PHI= 139.9	DEG	
2.16274		V/V					
F= 211	HZ	B/A= 8.59998		DB	PHI= 130	DEG	
2.69153		V/V					
F= 242	HZ	B/A= 10.2999		DB	PHI= 120.5	DEG	
3.27338		V/V					
F= 278	HZ	B/A= 11.7999		DB	PHI= 111.1	DEG	
3.89042		V/V					
F= 319	HZ	B/A= 13.2001		DB	PHI= 101.6	DEG	
4.57092		V/V					
F= 367	HZ	B/A= 14.4		DB	PHI= 91.9	DEG	
5.24809		V/V					
F= 422	HZ	B/A= 15.5		DB	PHI= 82.2999	DEG	
5.95662		V/V					
F= 485	HZ	B/A= 16.4		DB	PHI= 73.6	DEG	
6.60696		V/V					
F= 557	HZ	B/A= 17.2001		DB	PHI= 65.2001	DEG	
7.24442		V/V					
F= 639	HZ	B/A= 17.7999		DB	PHI= 57.4	DEG	
7.76241		V/V					
F= 735	HZ	B/A= 18.4		DB	PHI= 49.7999	DEG	
8.31766		V/V					
F= 844	HZ	B/A= 18.7999		DB	PHI= 42.7999	DEG	
8.70956		V/V					
F= 970	HZ	B/A= 19.2001		DB	PHI= 36.2001	DEG	
9.12019		V/V					
F= 1114	HZ	B/A= 19.5		DB	PHI= 30	DEG	
9.44061		V/V					
F= 1279	HZ	B/A= 19.7001		DB	PHI= 24.4	DEG	
9.66059		V/V					
F= 1470	HZ	B/A= 19.7999		DB	PHI= 18.9	DEG	
9.77229		V/V					
F= 1683	HZ	B/A= 19.9		DB	PHI= 13.7999	DEG	
9.88556		V/V					
F= 1940	HZ	B/A= 20	DB	PHI= 8.79993	DEG		
10.		V/V					

29 MARS 1978

00102

VLF 34
CAL INT

F= 2228	HZ	B/A= 20.1	DB	PHI= 4	DEG
10.1158	V/V				
F= 2559	HZ	B/A= 20.2001	DB	PHI=-.700104	DEG
10.233	V/V				
F= 2940	HZ	B/A= 20.2999	DB	PHI=-5.59973	DEG
10.3513	V/V				
F= 3377	HZ	B/A= 20.2999	DB	PHI=-10.5005	DEG
10.3513	V/V				
F= 3880	HZ	B/A= 20.2999	DB	PHI=-15.7999	DEG
10.3513	V/V				
F= 4457	HZ	B/A= 20.2999	DB	PHI=-21.4	DEG
10.3513	V/V				
F= 5119	HZ	B/A= 20.2999	DB	PHI=-27.501	DEG
10.3513	V/V				
F= 5881	HZ	B/A= 20.2001	DB	PHI=-34.1	DEG
10.233	V/V				
F= 6755	HZ	B/A= 20.1	DB	PHI=-41.502	DEG
10.1158	V/V				
F= 7760	HZ	B/A= 19.9	DB	PHI=-49.7999	DEG
9.88556	V/V				
F= 8914	HZ	B/A= 19.7001	DB	PHI=-59.2999	DEG
9.66059	V/V				
F= 10240	HZ	B/A= 19.2999	DB	PHI=-70.1	DEG
9.22564	V/V				
F= 11762	HZ	B/A= 18.7999	DB	PHI=-82.7001	DEG
8.70956	V/V				
F= 13511	HZ	B/A= 17.9	DB	PHI=-98.2001	DEG
7.85238	V/V				
F= 15520	HZ	B/A= 15.5	DB	PHI=-120.6	DEG
5.95662	V/V				
F= 17828	HZ	B/A= 15.2001	DB	PHI=-77.2001	DEG
5.75445	V/V				
F= 20480	HZ	B/A= 16.4	DB	PHI=-121.3	DEG
6.60696	V/V				
F= 23525	HZ	B/A= 14.7999	DB	PHI=-145.508	DEG
5.49536	V/V				
F= 27023	HZ	B/A= 12.7001	DB	PHI=-167.7	DEG
4.31523	V/V				
F= 31042	HZ	B/A= 9.5	DB	PHI=-190.3	DEG
2.98538	V/V				
F= 35657.	HZ	B/A= 3.79993	DB	PHI=-186.2	DEG
1.5488	V/V				
F= 40960.	HZ	B/A= 6.20007	DB	PHI= 151.5	DEG
2.04175	V/V				
F= 47051.	HZ	B/A= 2.79993	DB	PHI= 124.5	DEG
1.38037	V/V				
F= 54047.	HZ	B/A=-1.20013	DB	PHI= 103.4	DEG
.87095	V/V				
F= 62084.	HZ	B/A=-5.89978	DB	PHI= 88.2999	DEG
.507004	V/V				
F= 71316.	HZ	B/A=-8.59998	DB	PHI= 74.6	DEG
.371536	V/V				

VLF 34
CAL INT (SPITE)

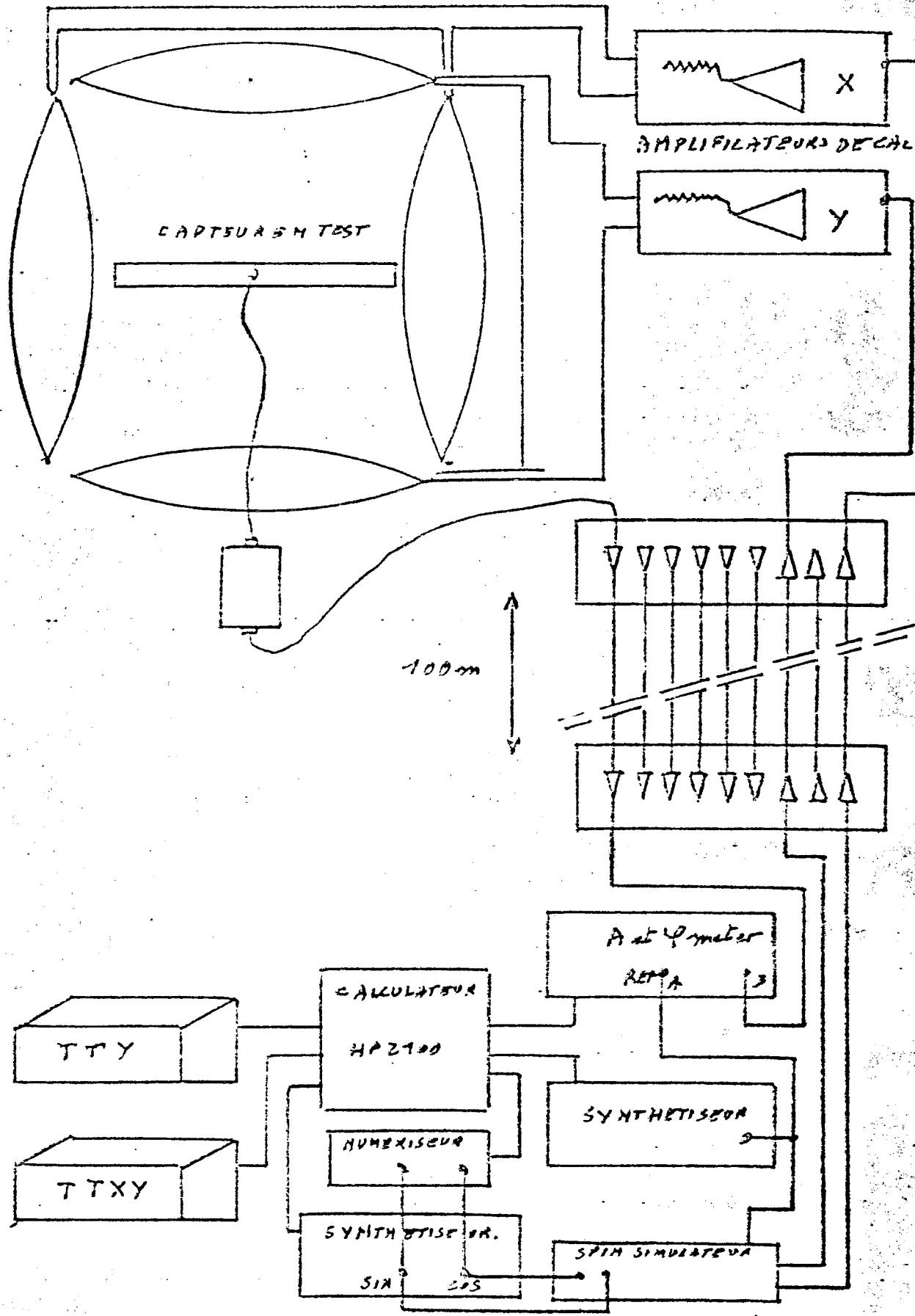

Repère	N° plan	Nbre	Désignation	Matière
CREE	CENTRE DE RECHERCHE EN PHYSIQUE DE L'ENVIRONNEMENT			Date: 9 JUN 71
				Dessiné: F. X. SENE
			MAGNETOMETRE SOL	Echelle:
			DIAGRAMME DE RECEPTION	CNET
			(MESURE)	
Modifications				NO 50

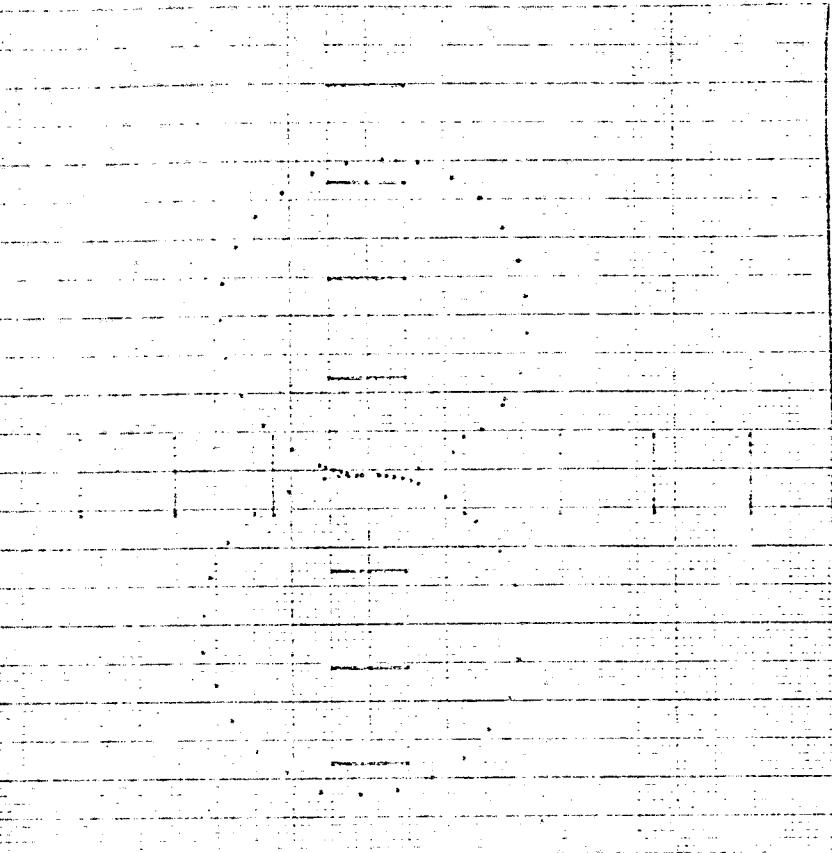

FILE SDL 12 HI XY

PLAN XY

MAX=-9.56337	ANGLE= 268.268
MIN=-31.5999	ANGLE= 358.613
MIN=-34.2	ANGLE= 176.6

BB 4043
(DUMEX)

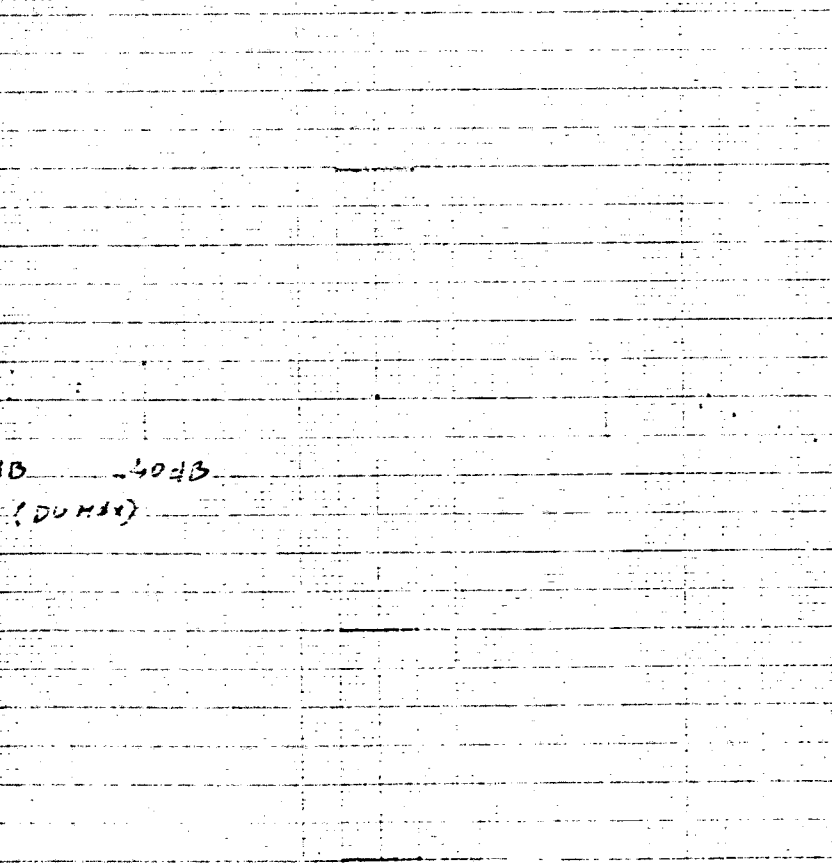

ELRSOL 122 HZ XY

MAX=-7.15993
MIN=-37.1001
MIN=-40.8

ANGLE= 271.245
ANGLE= 359.172
ANGLE= 177.874

03 -40.17
(20.M.S.)

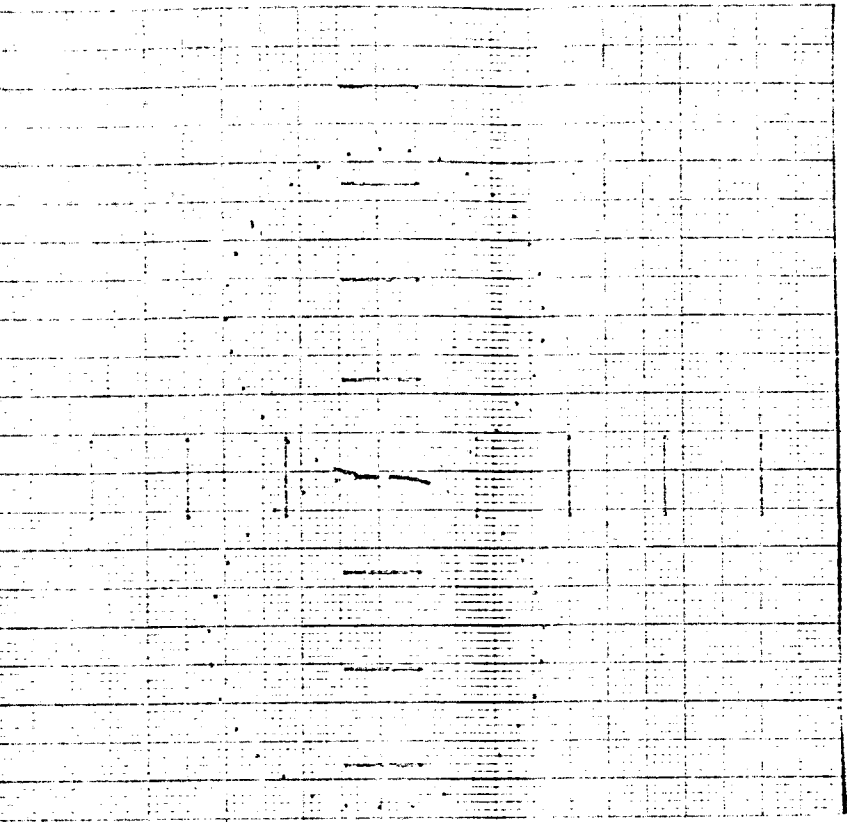

ELE SOL 457HZ XY

PLAN XY

MAX=-9.45998	ANGLE= 90
MIN=-33.6001	ANGLE= .416185
MIN=-33	ANGLE= 359.168
MIN=-34.1001	ANGLE= 178.586
MIN=-33.901	ANGLE= 177.455
MIN=-34.5	ANGLE= 176.6

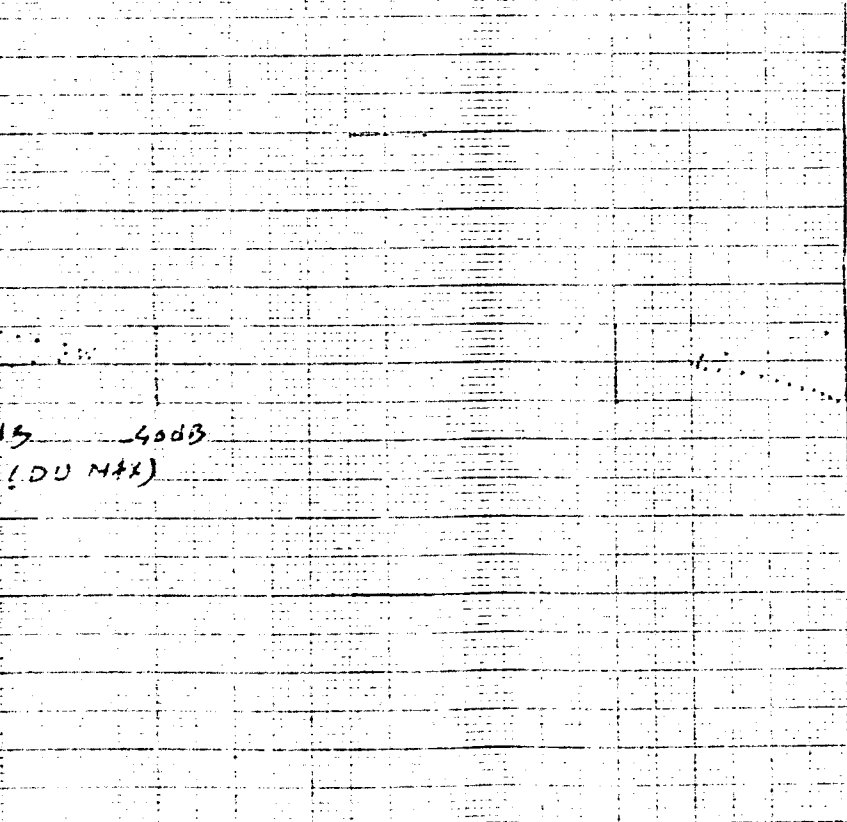

15 40dB
(DU MAX)

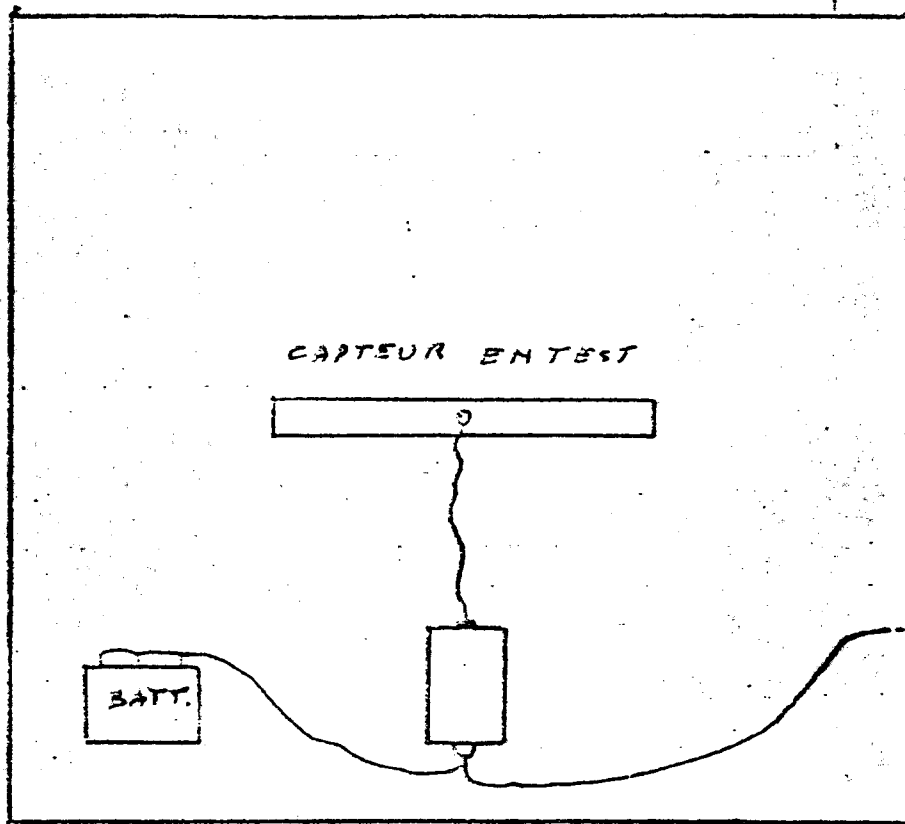

CHAMBRE METAL

2 m x 2 m x 2 m
(ESTEC)

50 m

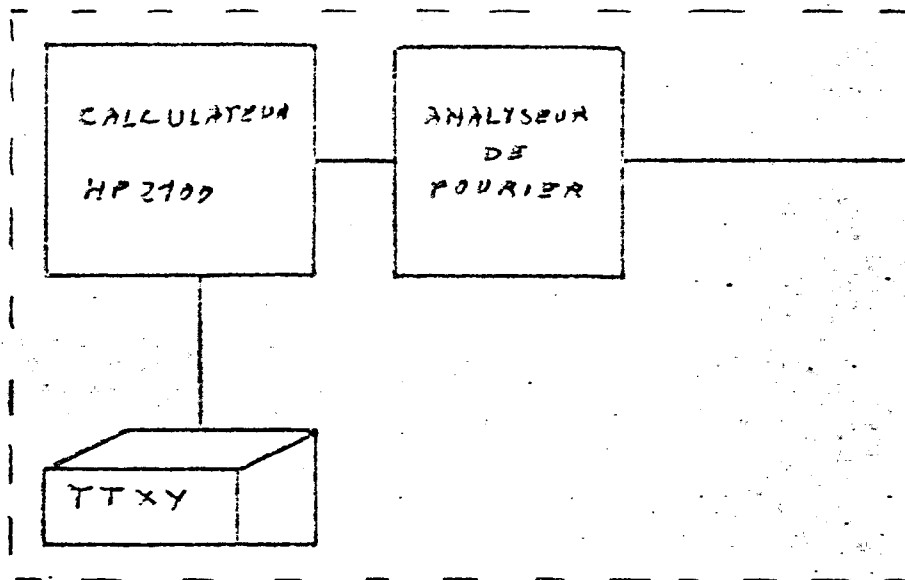

Repère	No plan	Nbre	Désignation	Matière
CREE			CENTRE DE RECHERCHE EN PHYSIQUE DE L'ENVIRONNEMENT	Date: 8 JUN 76 Dessiné: F.X. SENE
			MAGNETOMETRE SOL MESURE DE LA SENSIBILITE	Echelle: CNET
Modifications				No 54

V. HZ $\frac{1}{2}$

DEBIT DE SORTIE ELF

55

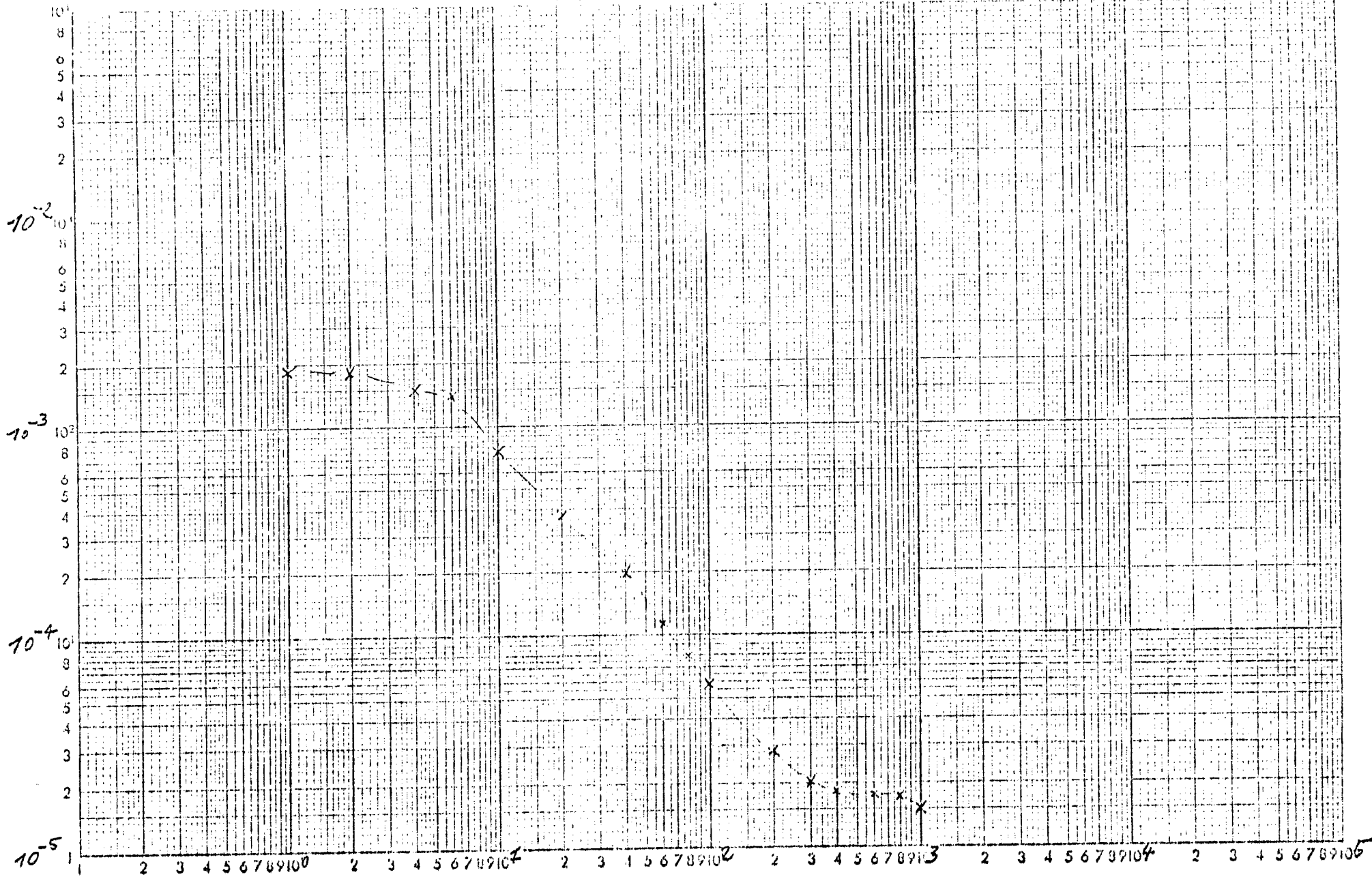

N° 1033

FREQUENCE (HZ)

$\gamma \cdot 112^{-\frac{1}{2}}$

SENSIBILITE ELF

56

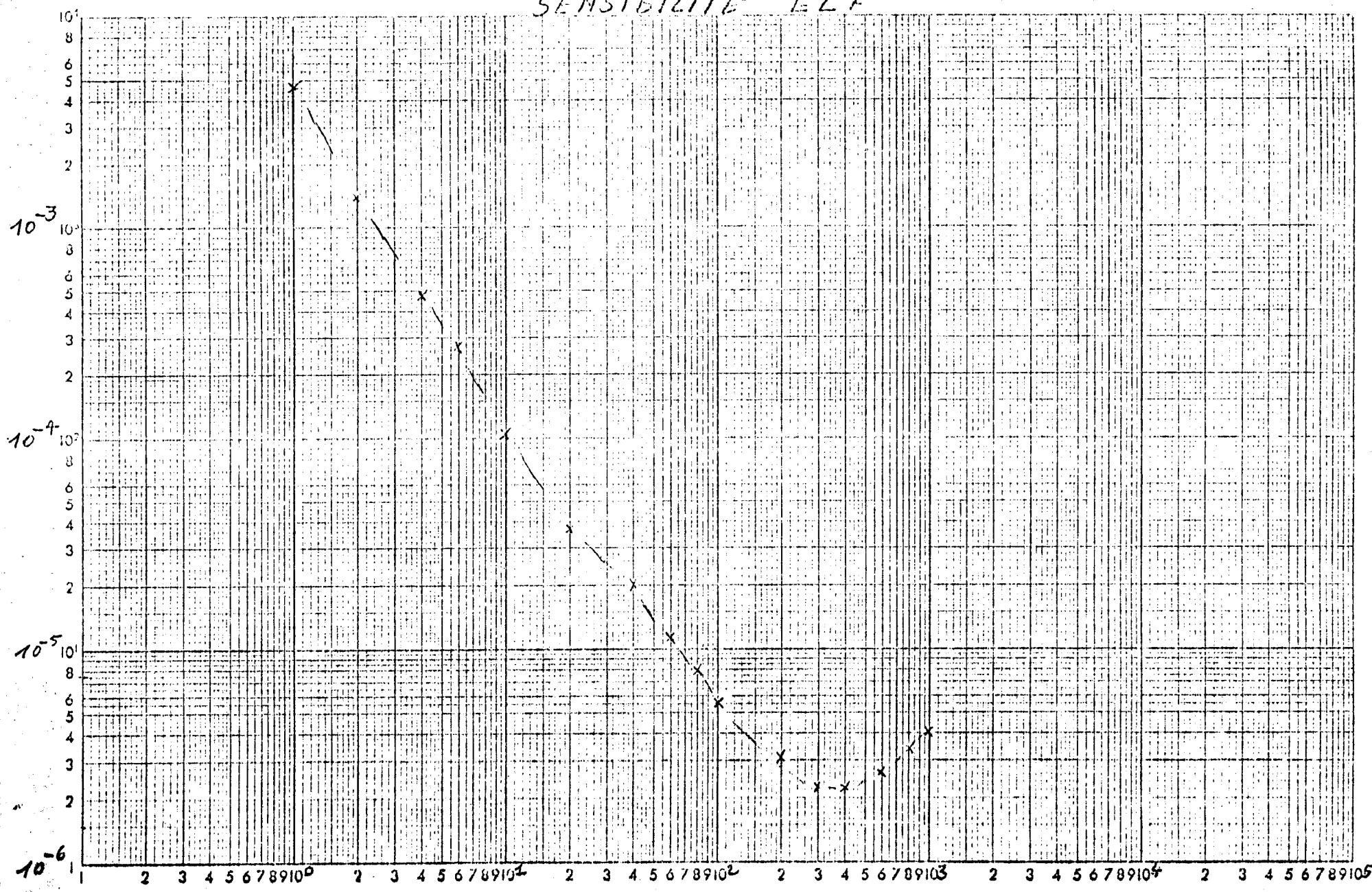

N° 1033

FREQUENCE (Hz)

$V.H^{-1/2}$

BRUIT DE SORTIE VLF

57

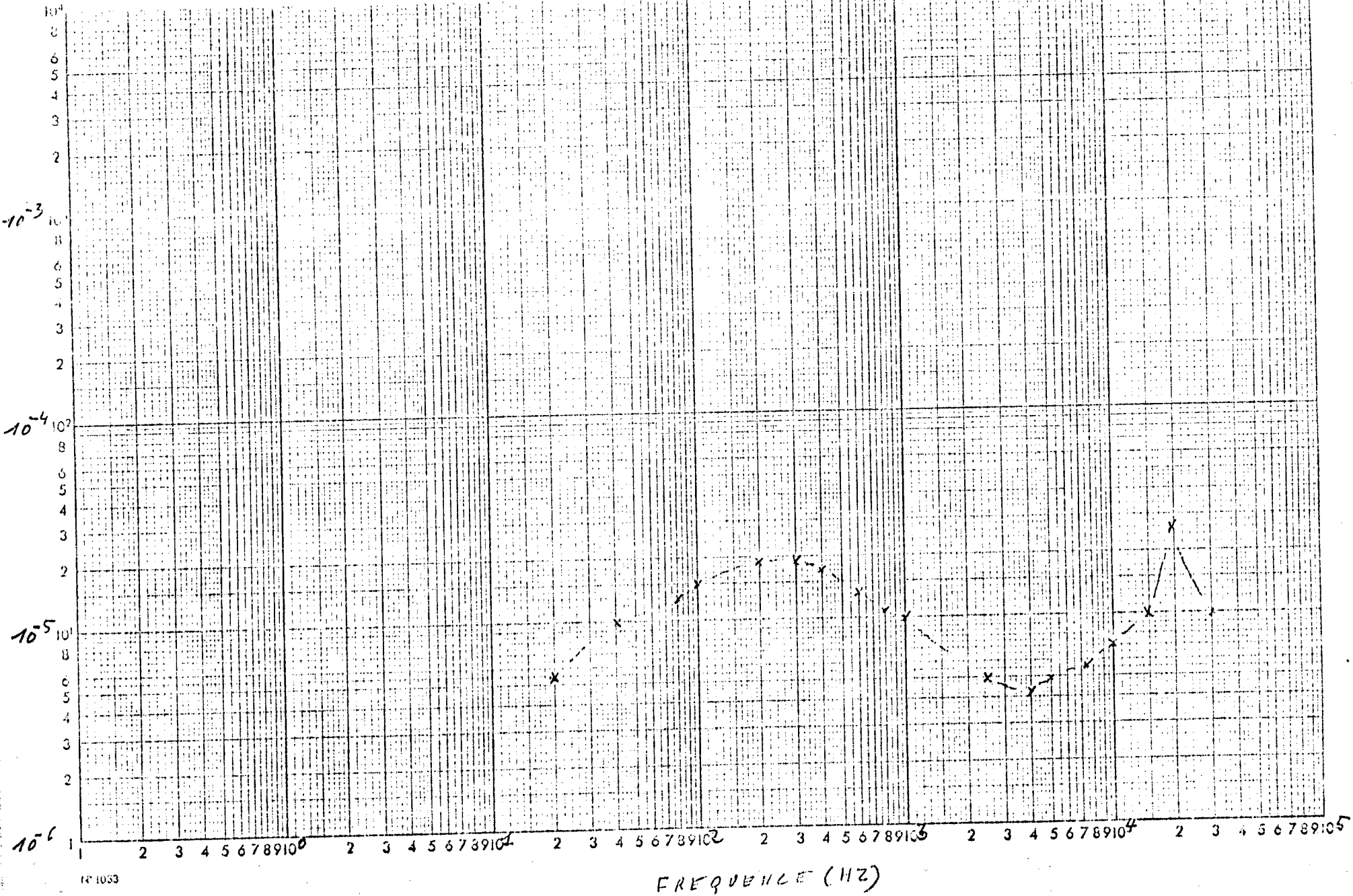

$\gamma \cdot \nu \cdot \nu^{-\frac{1}{2}}$

SENSIBILITE VLF

58

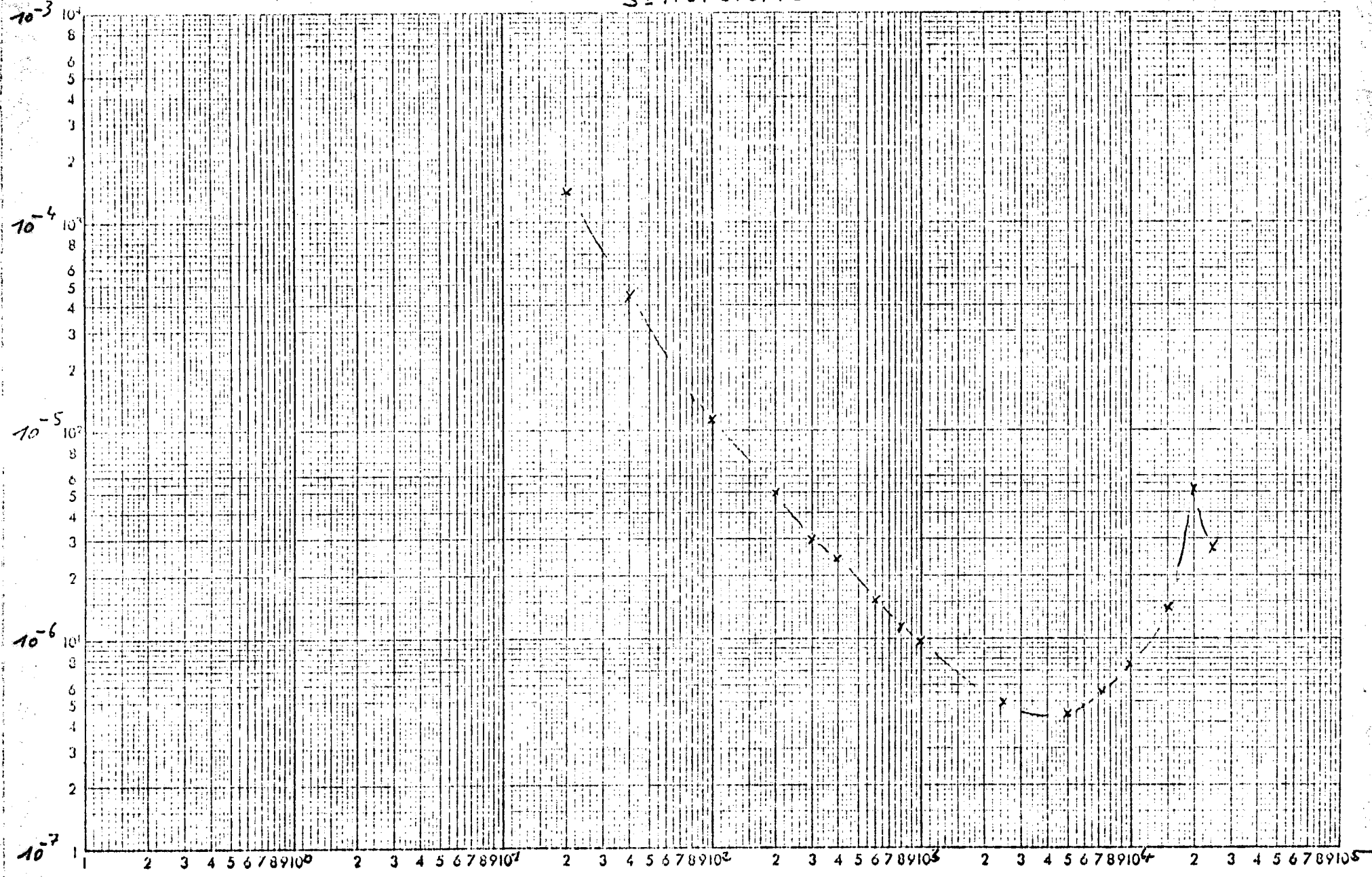

N° 1033

FREQUENCE (Hz)

GAIN DU PA E.L.F. en dB

$G = 38.000 = 57,6 \text{ dB}$
 à 20%
 E.L.F. 10V

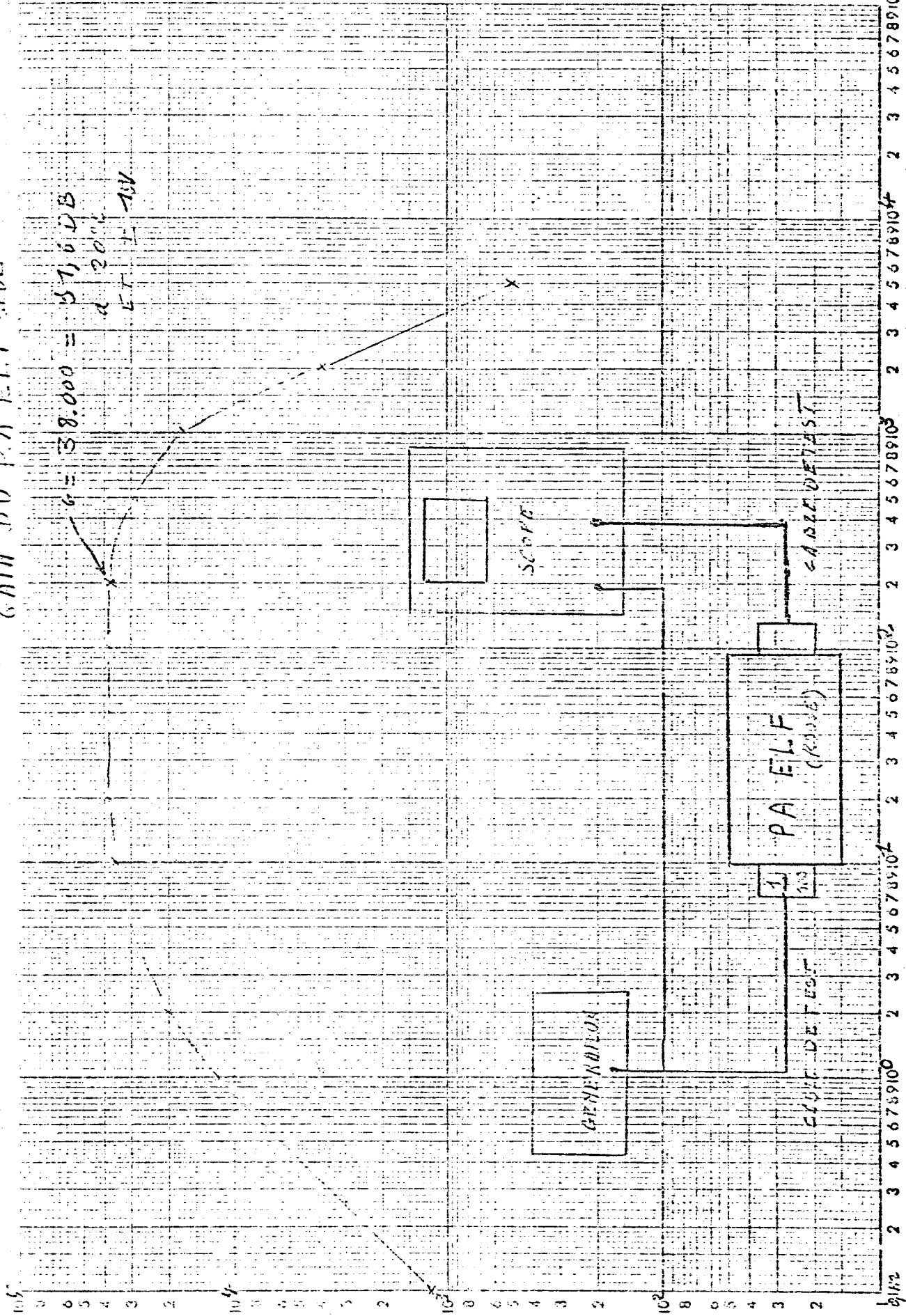

FRÉQUENCE (Hz)

N° 1013

GAIN DU PA VLF SCUL

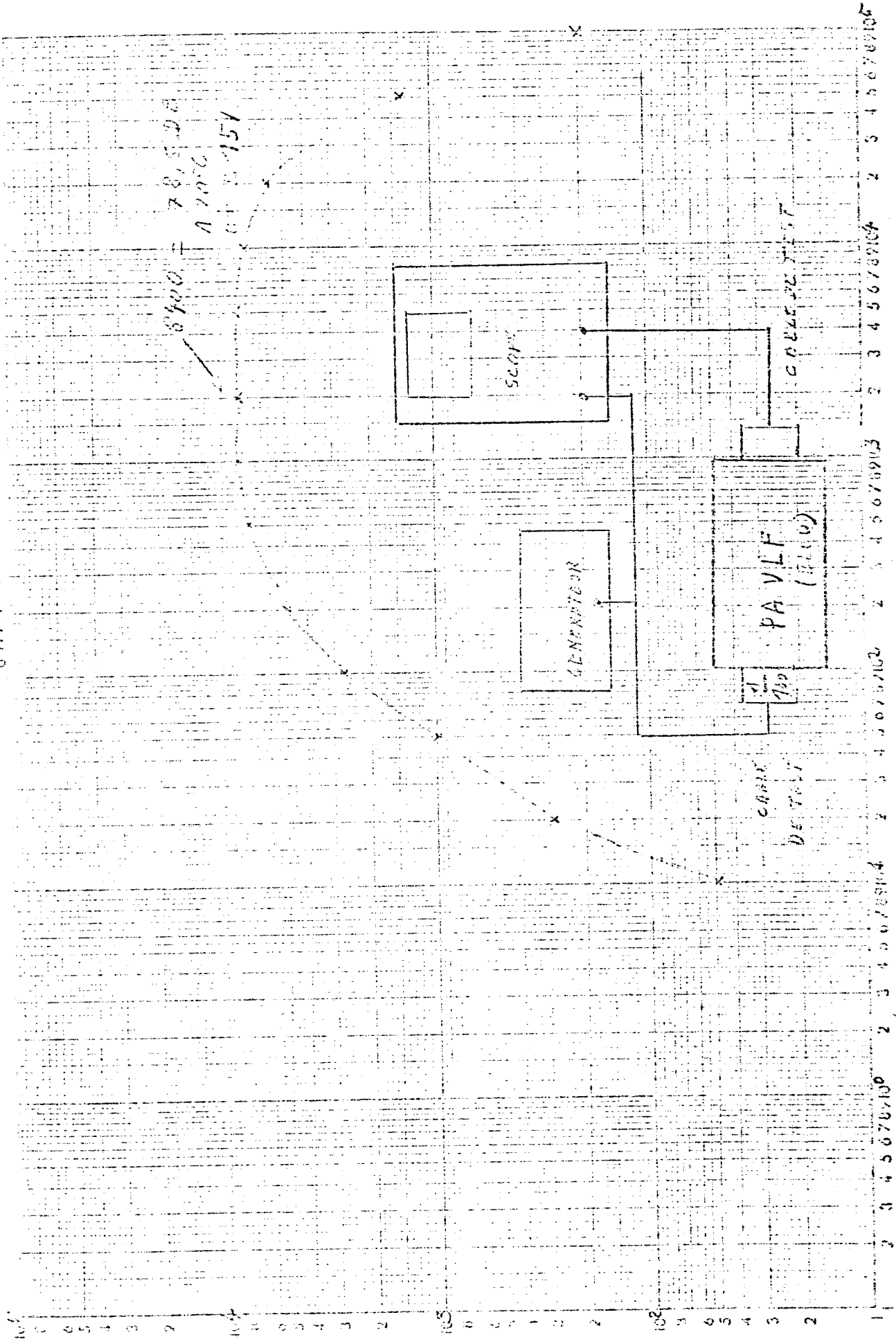

FREQUENCE (Hz)

CRPE
*Centre de Recherches
en Physique de l'Environnement
terrestre et planétaire*

*Avenue de la Recherche scientifique
45045 ORLEANS CEDEX*

Département PCE
*Physique et Chimie
de l'Environnement*

*Avenue de la Recherche scientifique
45045 ORLEANS CEDEX*

Département ETE
*Etudes par Télédétection
de l'Environnement*

*CNET - 38-40 rue du général Leclerc
92131 ISSY-LES-MOULINEAUX*