



HAL
open science

Recognitions of figures with two-dimensional cellular automata.

Laure Tougne

► **To cite this version:**

Laure Tougne. Recognitions of figures with two-dimensional cellular automata.. [Research Report] LIP RR-1994-39, Laboratoire de l'informatique du parallélisme. 1995, 2+85pp. hal-02102119

HAL Id: hal-02102119

<https://hal-lara.archives-ouvertes.fr/hal-02102119>

Submitted on 17 Apr 2019

HAL is a multi-disciplinary open access archive for the deposit and dissemination of scientific research documents, whether they are published or not. The documents may come from teaching and research institutions in France or abroad, or from public or private research centers.

L'archive ouverte pluridisciplinaire **HAL**, est destinée au dépôt et à la diffusion de documents scientifiques de niveau recherche, publiés ou non, émanant des établissements d'enseignement et de recherche français ou étrangers, des laboratoires publics ou privés.

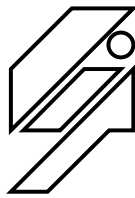

Laboratoire de l'Informatique du Parallélisme

Ecole Normale Supérieure de Lyon
Unité de recherche associée au CNRS n°1398

*Recognition of figures with
two-dimensional cellular automata*

Laure Tougne

December 1994

Research Report N° 94-39

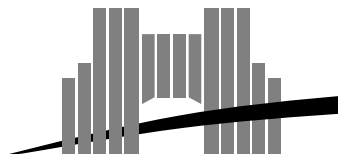

Ecole Normale Supérieure de Lyon

46 Allée d'Italie, 69364 Lyon Cedex 07, France

Téléphone : (+33) 72.72.80.00 Télécopieur : (+33) 72.72.80.80

Adresse électronique : lip@lip.ens-lyon.fr

Recognition of figures with two-dimensional cellular automata

Laure Tougne

December 1994

Abstract

We consider a family of figures of the discrete plane (rectangles, squares, ellipses,...); how shall we decide with a 2D cellular automaton whether a given figure belongs to the family or not?

We essentially give three kinds of results. First, we look for a parallel way of defining the family. For example, a rectangle is a connected figure without hole such that all cells that are in the border have exactly two neighbors in the border. We show that this definition is equivalent to the classical one and give a cellular automaton which recognizes the rectangles' family in an optimal time. Secondly, the figures are defined with the help of an algorithm which can be easily parallelized. A natural and meaningful example is the ellipses' recognition. An ellipse is a figure with two distinguished cells (the focuses); it is composed of all the cells the sum of distances to the two focus of which is less than a constant k (for the norm $\| \cdot \|_1$ or $\| \cdot \|_\infty$). In this case, the algorithm of recognition is the following one: a signal, generated by one of the focuses, spreads with an optimal speed in all the possible directions, and it is reflected back by the border of the pattern. The figure is an ellipse if and only if all these signals are resorbed on the other focus.

Finally, we present an other algorithm inspired by a synchronization algorithm due to F. Grasselli. in order to recognize the squares' family.

Keywords: 2D cellular automata, recognition, family of figures, synchronization

Résumé

Nous considérons une famille de figures du plan discret (rectangles, carrés, ellipses,...); comment décider à l'aide d'un automate cellulaire plan, si une figure donnée appartient à la famille? Nous donnons essentiellement trois types de résultats. Premièrement, nous cherchons un mode de définition de la famille de figures qui soit parallèle. Par exemple, un rectangle est une figure connexe sans trou telle que toute case du bord a exactement deux voisines dans le bord. Nous montrons que cette définition est équivalente à la définition classique du rectangle et exhibons un automate cellulaire reconnaissant la famille des rectangles en temps optimal.

Deuxièmement, les figures sont définies par un algorithme facilement parallélisable et, un exemple naturel et très démonstratif est la reconnaissance des ellipses. Une ellipse est une figure avec deux cases distinguées (les foyers), formée de toutes les cases dont la somme des distances aux deux foyers (pour la norme $\| \cdot \|_1$ or $\| \cdot \|_\infty$) est inférieure à une constante k . Dans ce cas, l'algorithme de reconnaissance est le suivant: un signal engendré par un des deux foyers se diffuse à vitesses maximale dans toutes les directions du plan, puis est réfléchi par le bord de la figure. La figure est une ellipse si et seulement si tous ces signaux se résorbent sur l'autre foyer.

Pour finir, nous présentons un algorithme inspiré d'un algorithme de synchronisation de F. Grasselli pour reconnaître la famille des carrés.

Mots-clés: Automates cellulaires plans, reconnaissance, famille de figures, synchronisation

Contents

1	Introduction.	2
2	Basic notions.	5
2.1	Cellular automata	5
2.2	Neighborhoods	6
2.3	Figures	7
2.4	Recognition of figures	9
3	Recognition of rectangles.	11
3.1	Definition of a rectangle.	11
3.2	Demonstration.	12
3.2.1	The Jordan's lemma for \mathbb{Z}^2	13
3.2.2	Construction of a sequence which describes of the border of F	14
3.2.3	Study of the path.	22
3.2.4	Characterization of F	26
3.3	An automaton which recognizes the rectangles.	27
3.4	Conclusion.	29
4	Recognition of squares.	31
4.1	Introduction.	31
4.2	Definition of the square.	31
4.3	Demonstration.	33
4.4	An automaton which recognizes the squares.	35
4.5	Conclusion.	38
5	Recognition of patterns which are built with rectangles.	39
5.1	Definitions	39
5.1.1	Coming out and retracting vertices	39
5.2	Recognition of "L".	40
5.2.1	Definition of the L family.	40
5.2.2	Automaton which recognizes L	41

5.2.3	Automaton which recognizes the "L" family using cells that are outside the figure.	43
5.3	Recognition of "U".	43
5.3.1	Definition of the U family.	43
5.3.2	Automaton which recognizes the "U".	44
5.3.3	Automaton which recognizes the U family using cells that are outside the figure.	46
5.4	Recognition of "O".	46
5.4.1	Definition of the O family.	46
5.4.2	Automaton which recognizes the "O".	47
5.5	Recognition of "T".	47
5.5.1	Definition of the "T" family: T	48
5.5.2	Automaton which recognizes the "T".	49
5.6	Generalization.	49
5.6.1	Encoding of a figure	49
5.6.2	A more general family of figure	50
5.7	Conclusion	51
6	Recognition of ellipses.	52
6.1	Introduction.	52
6.2	An automaton which recognizes the $4 - ellipses$	54
6.3	Demonstration.	54
6.4	Particular cases.	57
6.4.1	Case where the focuses are merged.	57
6.4.2	Case of the isocetes triangle.	58
6.5	$8 - ellipses$	59
6.6	conclusion	59
7	Conclusions.	61
7.1	Extensions.	61
7.1.1	Other figures.	61
7.1.2	Properties.	65
7.1.3	Implementation.	65
7.2	Link with the Firing Squad problem.	66
7.2.1	The Firing Squad problem.	66
7.2.2	Solutions that are proposed by Szwerinski.	67
7.2.3	Questions.	71
8	Addendum	72

Chapter 1

Introduction.

Cellular automata (in short *CA*) were introduced by J.von Neumann [vN67] in the beginning of the sixties, according to S. Ulam's ideas, as a model of self reproduction.

Cellular automata are finite automata which are regularly connected each other. They can be considered as dynamic systems. In its general historical form, a cellular automaton of dimension d is an infinite set of identical elementary finite machines (called *cells*, which are indexed by \mathbb{Z}^d). A cell is a finite automaton which evolves according to some receiving information and according to its past *state* which it keeps in memory (it has only a finite number of states). Thus, at the initial moment, all cells are in a given state and the system evolves as follows:

- Synchronously: The new time is obtained when all cells have changed their state.
- Uniformly: The new state of a cell depends on the states of other cells which depend themselves on other cells that in the same way for all components of the network.
- Locally: The new state of a cell depends only on a finite number of cells which are in a bounded neighborhood.

Cellular automata have been studied as languages' recognizers and, more recently as functions' computers. One of their application is the study of massively parallel algorithms in order to spread and to synchronize local information.

In the following discussion, we develop a new utilization of cellular automata: we want to recognize families of figures with 2D cellular automata. As far as I know, no paper has previously been published about this subject.

This report contains different families of figures we tried to recognize. This families are grouped in two parts.

In the first part, we search for the "most locally possible" definition of the figure.

The main example is the rectangle's family: a rectangle is a discrete connected figure, without hole which has exactly four vertexes or, a connected figure, without hole, all border cells of which have two border cells in their neighborhood. So, considering a connected figure which has no hole, the examination of the borders is sufficient to determine if the figure is a rectangle or not. Likewise concerning the square: it's a rectangle which has a symmetry property, which is detected at the heart of the square.

In this part, are also some families of figures such as the "L's family", the "U's family", the "O's family" ... These families are globally defined. In this case, we count the number of retracting vertexes the figure has in order to recognize it.

In the second part, we have figures which bring into play waves evolving on the plane. For example, we have the ellipses' family: an ellipse is a figure with two distinguished cells (the focuses); it is composed of all the cells the sum of distances to the two focus of which is less than a constant k . In order to recognize this family of figures, we utilize a two dimensional signal which spread as a one-dimensional one. On a line, a wave spreads like that: at each top, each reached cell communicates the information to its not reached neighborhood, if it has one (see the figure 1.1). On the plane, it is a wave which seems to be a

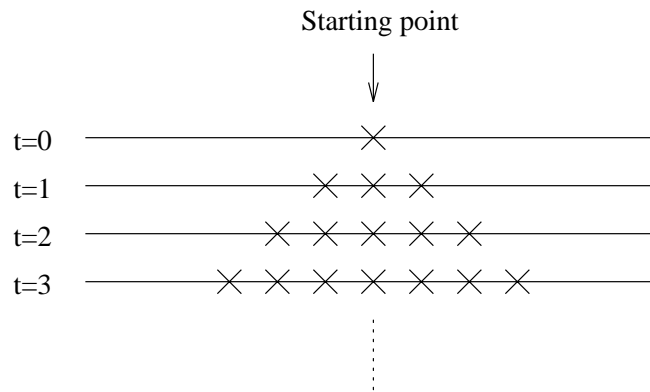

Figure 1.1: Propagation of a one-dimensional wave.

volume in the space-time diagram (it's a three-dimensional diagram). Thus, a signal which has the quickest speed appears as a pyramid, if the neighborhood is the Von Neumann's one (see figure 1.2). The wave form depends on neighborhood. We can define a line in terms of wave: "A wave which starts from a focus, disappears on the other focus".

Then, there exist figures which can be defined in terms of wave.

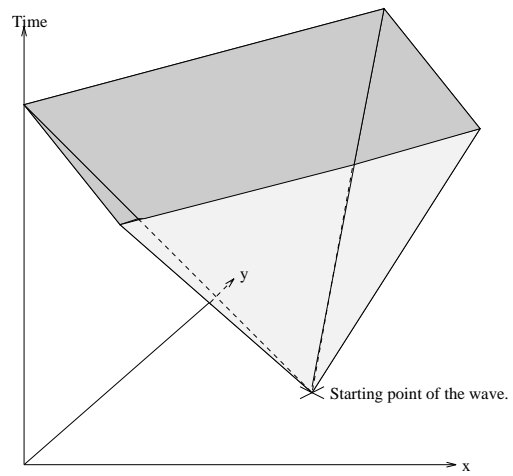

Figure 1.2: Space-time diagram of a 2D wave which spreads at quickest speed.

Chapter 2

Basic notions.

Our goal is to recognize families of figures with plane cellular automata. In this section, we define notions which are useful to understand the rest.

2.1 Cellular automata

Definition 1 (Cellular automata)

A *two-dimensional cellular automaton*, A , is a 4-tuple (d, S, H, δ) such that:

- $d = 2$, is called the dimension,
- S is a finite set, the elements of which are called the states and denoted by:
 $S = \{s_k; k \in \{0, \dots, |S| - 1\}\}$,
- H is a finite set of \mathbb{Z}^2 , called the neighborhood and denoted by:
 $H = \{v_j = \{s_{1,j}, s_{2,j}\}; j \in \{1, \dots, |H|\}\}$,
- δ is a function from $S^{|H|}$ to S , called the local transition function.

The cellular automata we consider are two-dimensional ones: we put in each point of \mathbb{Z}^2 , called *cell*, the same finite automaton.

Let A be a cellular automaton.

Definition 2 (Configuration of a cellular automaton)

A *configuration* C_A of A is an application from \mathbb{Z}^2 to S . A configuration C_A evolves to another configuration C_A^* defined by:

$\forall (x, y) \in \mathbb{Z}^2, C_A^*(x, y) = \delta(C_A(x + x_{1,1}, y + x_{2,1}), \dots, C_A(x + x_{1,|H|}, y + x_{2,|H|}))$.
We denote this evolution by $C_A \vdash C_A^*$ and we call it the global function of A .

Starting from an initial configuration C_A^0 , we obtain an infinite sequence of configurations C_A^t ; $t \in \mathbb{N}$ defined by $\forall t \in \mathbb{N}, C_A^t \vdash C_A^{t+1}$.

A cell enters a new state according to its state and the states of its adjacent cells in which we apply δ .

2.2 Neighborhoods

Let H be the considered *neighborhood*.

Definition 3 (Von Neumann's neighborhood)

Let $(x, y) \in \mathbb{Z}^2$, the Von Neumann's neighborhood of the cell (x, y) is the set of cells, denoted by $H_4(x, y)$, such that: $H_4(x, y) = \{(x + 1, y), (x - 1, y), (x, y - 1), (x, y + 1)\}$.

We put $H_4^1(x, y) = (x, y - 1)$, $H_4^2(x, y) = (x - 1, y)$, $H_4^3(x, y) = (x, y + 1)$ and $H_4^4(x, y) = (x + 1, y)$.

See figure 2.1.

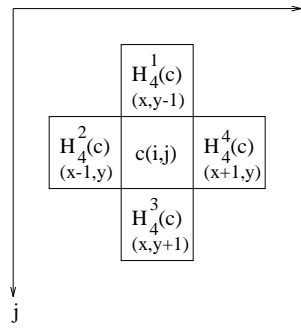

Figure 2.1: Von Neumann's neighborhood.

Definition 4 (Moore's neighborhood)

Let $(x, y) \in \mathbb{Z}^2$, the Moore's neighborhood of the cell (x, y) is the set of cells, denoted by $H_8(x, y)$, such that: $H_8(x, y) = \{(x + 1, y), (x - 1, y), (x, y - 1), (x, y + 1), (x + 1, y + 1), (x + 1, y - 1), (x - 1, y + 1), (x - 1, y - 1)\}$.

We put $H_8^1(x, y) = (x, y - 1)$, $H_8^2(x, y) = (x - 1, y - 1)$, $H_8^3(x, y) = (x - 1, y)$, $H_8^4(x, y) = (x - 1, y + 1)$, $H_8^5(x, y) = (x, y + 1)$, $H_8^6(x, y) = (x + 1, y + 1)$, $H_8^7(x, y) = (x + 1, y)$ and $H_8^8(x, y) = (x + 1, y - 1)$.

See figure 2.2.

Let us notice that the cells which are in the Von Neumann's neighborhood of the cell (x, y) are the cells which are one distance unit away from the cell (x, y) where the distance is d_4 ,

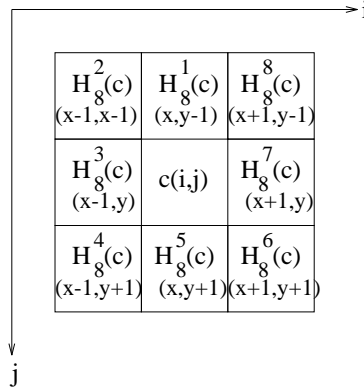

Figure 2.2: Moore's neighborhood.

$$d_4(P, Q) = |i_P - i_Q| + |j_P - j_Q|$$

This distance is called *City Block Distance* (or Square Distance).

In the Moore's case, the distance is d_8 ,

$$d_8(P, Q) = \max(|i_P - i_Q|, |j_P - j_Q|)$$

This distance is called *Chessboard Distance* (or Diamond Distance).

2.3 Figures

We consider the *discrete plane* \mathbb{Z}^2 .

Definition 5 (Figure)

We call *figure*, denoted by F , any finite subset of \mathbb{Z}^2 .

Definition 6 (4-connected path)

A *4-connected path* is any sequence of points of \mathbb{Z}^2 , $(x_0, y_0), (x_1, y_1), \dots, (x_l, y_l)$ such that $\forall i \in \{0, \dots, l-1\}$ ($x_{i+1} = x_i + 1$ and $y_{i+1} = y_i$) or ($x_{i+1} = x_i - 1$ and $y_{i+1} = y_i$) or ($x_{i+1} = x_i$ and $y_{i+1} = y_i + 1$) or ($x_{i+1} = x_i$ and $y_{i+1} = y_i - 1$).

Definition 7 (8-connected path)

A *8-connected path* is any sequence of points of \mathbb{Z}^2 , $(x_0, y_0), (x_1, y_1), \dots, (x_l, y_l)$ such that $\forall i \in \{0, \dots, l-1\}$ ($x_{i+1} = x_i + 1$ and $y_{i+1} = y_i$) or ($x_{i+1} = x_i - 1$ and $y_{i+1} = y_i$) or ($x_{i+1} = x_i$ and $y_{i+1} = y_i + 1$) or ($x_{i+1} = x_i$ and $y_{i+1} = y_i - 1$) or ($x_{i+1} = x_i + 1$ and $y_{i+1} = y_i + 1$) or ($x_{i+1} = x_i - 1$ and $y_{i+1} = y_i - 1$) or ($x_{i+1} = x_i + 1$ and $y_{i+1} = y_i - 1$) or ($x_{i+1} = x_i - 1$ and $y_{i+1} = y_i + 1$).

Definition 8 (Connected figure)

A figure F is *4-connected* (respectively *8-connected*) if and only if for all cells c

and c' in F such that $c \neq c'$, there exists a 4-connected (respectively 8-connected) path which connects c to c' .

The figure 2.3 shows examples of 4 and 8-connected paths and 4 and 8-connected figures.

Every figure we consider here are 4-connected or 8-connected.

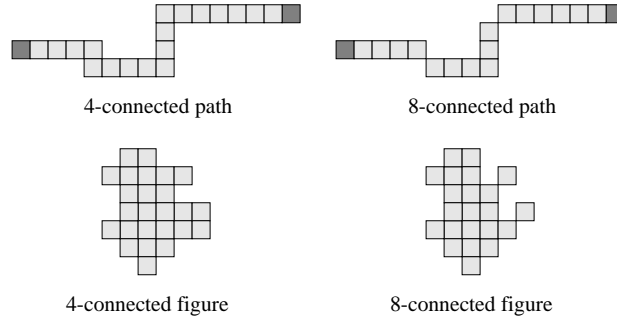

Figure 2.3: 4-connected and 8-connected paths, 4-connected and 8-connected figures.

Definition 9 (Figure without hole)

A figure F is without hole for d_4 (respectively d_8) if and only if \bar{F} (the complement of F in \mathbb{Z}^2) is 4-connected (respectively 8-connected).

Definition 10 (The external layer of a figure)

We define the external layer of the figure F , denoted by $L_{ext}(F)$, as follows:
 $L_{ext}(F) = \{(x, y) \in F; \exists x', y' \text{ with } ((x'=x+1 \text{ and } y'=y) \text{ or } (x'=x-1 \text{ and } y'=y) \text{ or } (x'=x \text{ and } y'=y+1) \text{ or } (x'=x \text{ and } y'=y-1)), (x', y') \notin F.\}$

$L_{ext}(F)$ is the set of cells that are on the border of F , that is to say the cells that have at least one cell in their neighborhood which is not in the figure F (see figure 2.4).

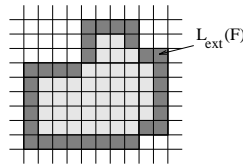

Figure 2.4: The external layer, $L_{ext}(F)$, of the figure F .

Definition 11 (Vertices of a figure) Let $v \in F$, we say that v is a vertex of F if and only if there exists c_1 and c_2 ($c_1 \neq c_2$) in $H(v)$ such that $c_1 \notin F$ and $c_2 \notin F$

See figure 2.5.

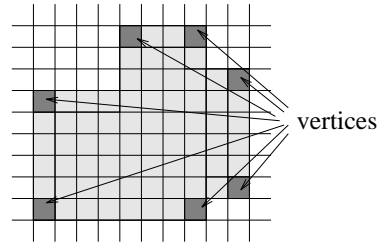

Figure 2.5: Vertices of a figure.

2.4 Recognition of figures

Definition 12 (The state of a cell)

Let $state(c, t)$ be the state of the cell c at time t .

Initially, $\forall c \in F, state(c, 0) = 1$ and $\forall c \notin F, state(c, 0) = 0$. The cells which belong to F are in state 1 and the others are in state 0.

The state of the cell (i, j) , at time $(t + 1)$, is completely determined by the state of (i, j) and the states of the adjacent cells at time t .

Definition 13 (Recognition of figures)

We have two notions of recognition:

- *The local recognition: one cell of the figure enters an accepting state or a rejection state.*
- *The global recognition: all the cells of the figure enter the same state: acceptance state or rejection state.*

Definition 14 (Family which is recognisable with 2-dimensional cellular automata)

We say that a family of figures, denoted by \mathcal{F} , is recognizable with 2D cellular automata if and only if there exists a cellular automaton A such that for every figure F on the plane there is a time t such that,

$$A^t(F) = a \text{ everywhere in } F \text{ (} a = \text{acceptance state).}$$

$$\text{Otherwise, } A^t(F) = r \text{ everywhere in } F \text{ (} r = \text{rejection state).}$$

That is to say there is an automaton which accepts all the figures of \mathcal{F} and which rejects all the others.

Definition 15 (Time of recognition)

We denote $rtime(P, A) = \min(t, \forall c \in F \text{ state}(c, t) = a \text{ or } \forall c \in F \text{ state}(c, t) = r)$
the recognition time of F with A if the figure F is recognizable with A .

It is the first time all the cells of the figure are in the same state (acceptance state or rejection state).

Chapter 3

Recognition of rectangles.

The goal of this part is to show that rectangles are recognizable by two-dimensional cellular automata. The idea here developed, consists in looking for the most locally possible definition of the rectangle and using this definition in order to construct a cellular automaton which allows to recognize it.

3.1 Definition of a rectangle.

Let us consider the rectangles' family, denoted by \mathcal{R} , that is to say the set of figures F such that:

$$\exists(i_0, j_0) \in \mathbb{Z}^2 \text{ and } (i_f, j_f) \in \mathbb{Z}^2; F = \{(i, j) \in \mathbb{Z}^2, i_0 \geq i \geq i_f \text{ and } j_0 \geq j \geq j_f\}$$

Now, we give a definition of the rectangles which is equivalent to the previous one but, which gives us a local characterization of the rectangles. In fact, we want this definition to indicate us the neighborhood of each cell of the figure. It will help us to construct a cellular automaton recognizing the rectangles' family.

Let F be a 4-connected figure without hole.

We have to keep in mind that, at time 0, all the cells which belong to F are in state 1 and the others are in state 0.

Let P_1 be the following property, associated to the figure F :

Property 1 (Property of the external layer of a figure)

$$\forall(i, j) \in L_{ext}(F), |H(i, j) \cap L_{ext}(F)| = 2$$

This property means that all the cells which belong to the external layer of the figure F , have exactly two adjacent cells which belong to this layer.

Then, we have the following theorem:

Theorem 1

A figure F is a rectangle if and only if F is 4-connected, without hole and $P_1(F)$ is true.

3.2 Demonstration.

In this section, we want to prove the previous theorem.

Let F be a figure which is 4-connected, without hole and which verifies the property P_1 . We want to show that F is a rectangle.

The proof is long then, we decompose it as follows:

In a first part, we present the Jordan's lemma for \mathbb{Z}^2 . It will be useful in order to demonstrate the following lemmas.

In a second part, we construct a sequence of cells which describes the border of the figure F : we take the upper-left most cell of the figure as the first element of the sequence and we go round the border the figure in the counterclockwise direction (see figure 3.1).

We show that the border of F is constituted by four parts: an horizontal part,

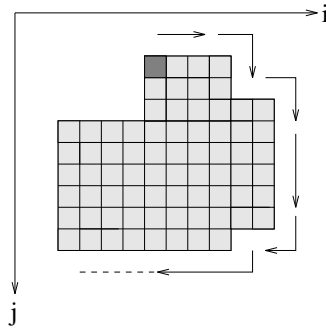

Figure 3.1: Description of the border of F .

a vertical part, an other horizontal part and an other vertical one (as in the figure 3.2). By an iterative process, we construct the rest of the sequence.

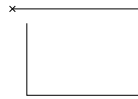

Figure 3.2: In a first time, the border of F is constituted by four parts

Then, we show that there are two cases: the sequence is either a spiral or the border of a rectangle (see figure 3.3).

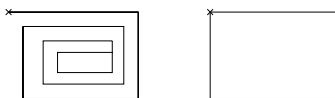

Figure 3.3: The constructed sequence is either a spiral or a rectangle

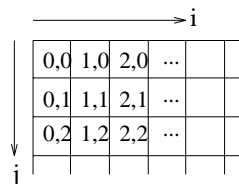

Figure 3.4: i and j axis.

In the third part, we show that the first case leads to a contradiction. In the fourth part, we deduce that the figure F is a rectangle the border of which is the sequence we have just constructed. In order to fix the ideas, we use the part of the grid which is shown in the figure 3.4.

3.2.1 The Jordan's lemma for \mathbb{Z}^2 .

Lemma 1 (Jordan's lemma for \mathbb{Z}^2)

Any connected path which connects the point (a, b) to the point $(a + 1, b - 1)$ meets any connected path which connects the point $(a + 1, b)$ to $(a, b - 1)$.

See figure 3.5.

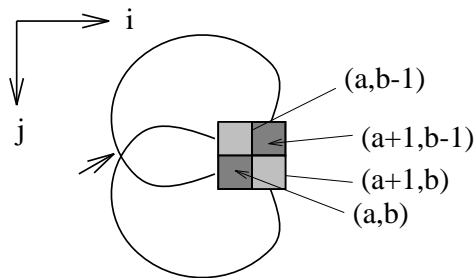

Figure 3.5: Jordan's lemma for \mathbb{Z}^2

This lemma has already been proved by Rosenfeld ([Ros70], [Ros73], [Ros74], [Ros75], [Ros79], [ROS89]).

3.2.2 Construction of a sequence which describes of the border of F

We study the position of the cells which are on the border of the figure. We start with the upper-left most cell and we go round the border of the figure in the counterclockwise direction.. As soon as we go round, we construct a 4-connected path, denoted by h_l for $0 \leq l \leq n$, which contains the meeting cells.

The first element, h_0 , of this path is the upper-left most cell the coordinates of which are i_0 and j_0 such that:

Definition 16 (Definition of (i_0, j_0))

We put $j_0 = \min\{j; \exists i, (i, j) \in F\}$ and $i_0 = \min\{i; (i, j_0) \in F\}$.

By definition of i_0 and j_0 , we have:

Fact 1

$(i_0, j_0) \in L_{ext}(F)$; $(i_0, j_0 + 1) \in L_{ext}(F)$; $(i_0 + 1, j_0) \in L_{ext}(F)$

Proof

$(i_0, j_0) \in F$ and $(i_0, j_0 - 1) \notin F$ because of the definition of j_0 then $(i_0, j_0) \in L_{ext}(F)$. $(i_0 - 1, j_0) \notin F$ because of the definition of i_0 . As $(i_0, j_0 - 1) \notin F$, $(i_0 - 1, j_0) \notin F$, $(i_0, j_0) \in L_{ext}(F)$ and F satisfies P_1 we have: $(i_0, j_0 + 1) \in L_{ext}(F)$ and $(i_0 + 1, j_0) \in L_{ext}(F)$. \square

See figure 3.6.

We go round the figure by the right. So, we first describe the higher border of the figure:

Lemma 2

There exists an index α such that $\forall k \in \{0, \dots, \alpha - 1\}$, $i_{k+1} = i_k + 1$, $j_{k+1} = j_k$ and $i_{\alpha+1} = i_\alpha$ and $j_{\alpha+1} = j_\alpha + 1$.

Proof.

See figure 3.7.

Let α be the first index such that $(i_\alpha + 1, j_\alpha) \notin L_{ext}(F)$. Then $(i_\alpha, j_\alpha - 1) \notin L_{ext}(F)$ with the definition of j_0 (we have $j_0 = j_1 = \dots = j_\alpha$). Therefore $(i_\alpha, j_\alpha + 1) \in L_{ext}(F)$ because F satisfy P_1 and $i_{\alpha+1} = i_\alpha$, $j_{\alpha+1} = j_\alpha + 1$. \square

Now, we successively give a description of the right, the bottom and the left most borders.

Lemma 3

There exists an index β ($0 \leq \alpha \leq \beta$) such that $\forall k \in \{\alpha, \dots, \beta - 1\}$, $i_{k+1} = i_k$, $j_{k+1} = j_k + 1$ and $i_{\beta+1} = i_\beta - 1$ and $j_{\beta+1} = j_\beta$.

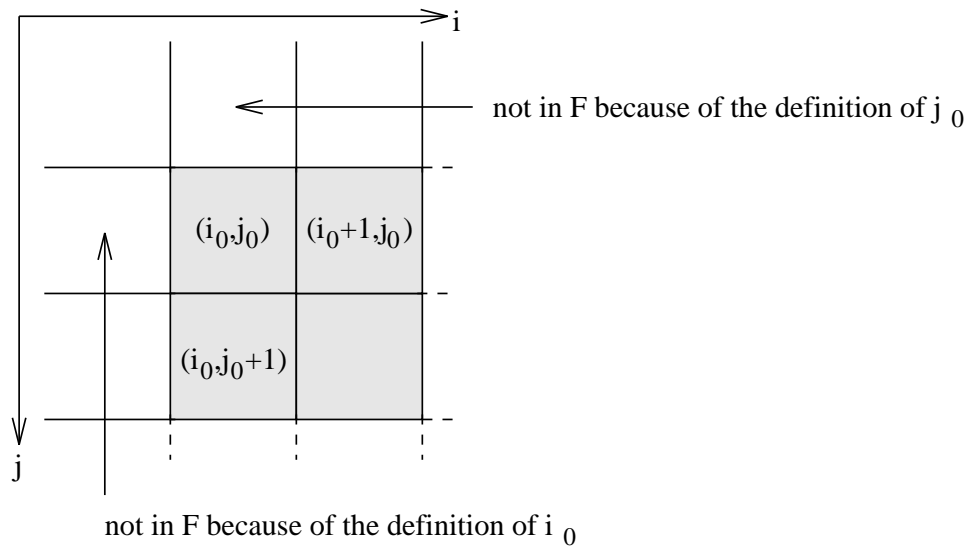

Figure 3.6: The adjacent cells of the upper-left most cell

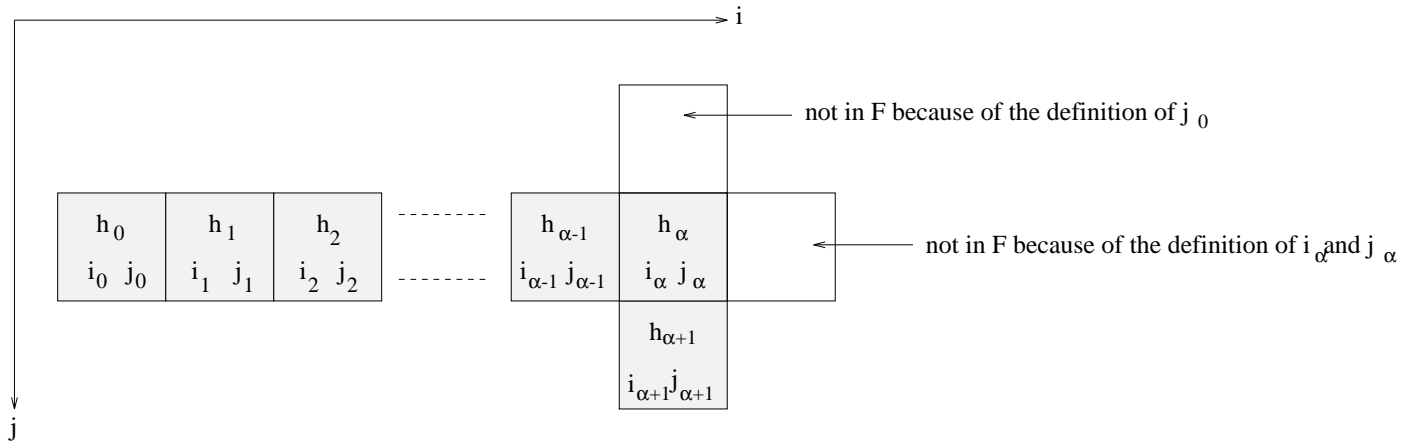

Figure 3.7: The higher border

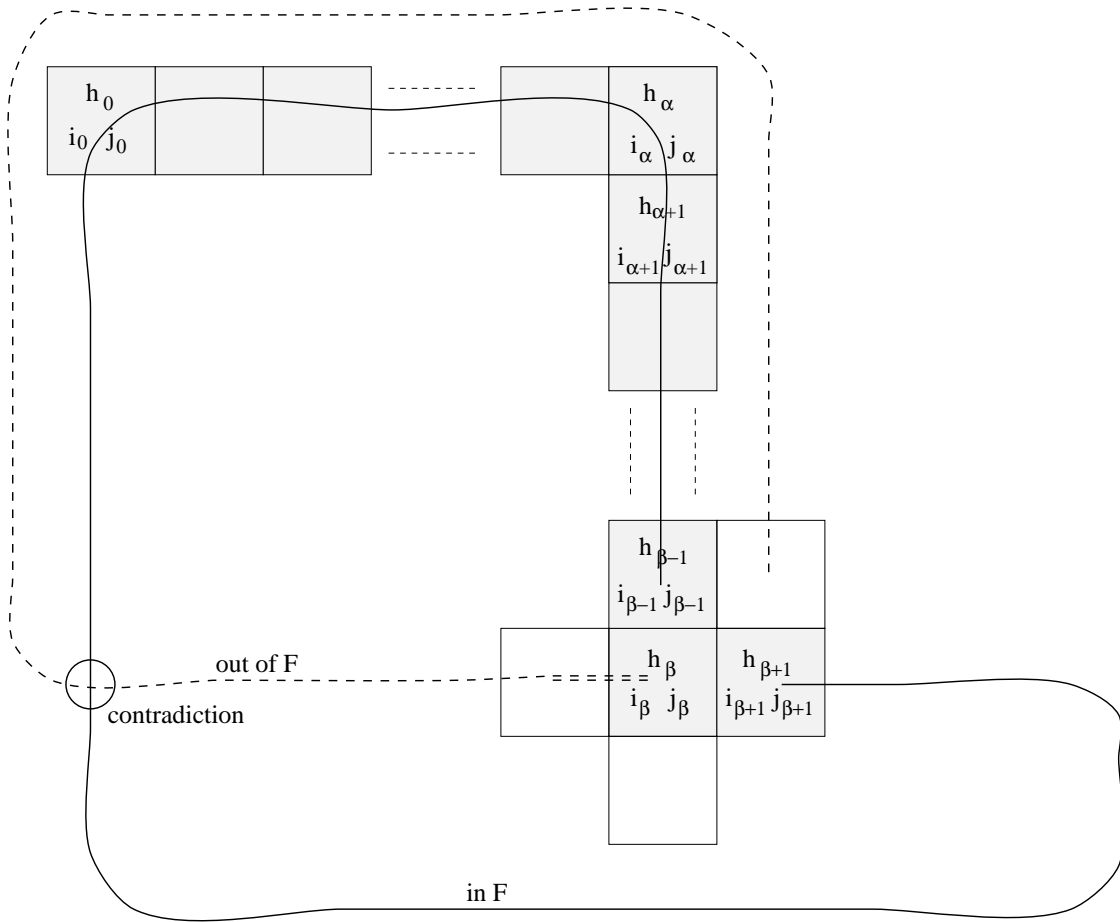

Figure 3.8: The righter border

Proof.

See figure 3.8.

Let β be the smaller index ($\beta > \alpha$) such that $(i_\beta, j_\beta + 1) \notin L_{ext}(F)$. Then, as F satisfies the property P_1 , if $(i_\beta + 1, j_\beta) \notin L_{ext}(F)$ then $(i_\beta - 1, j_\beta) \in L_{ext}(1)$. We show, by reduction to the absurd, that $(i_\beta + 1, j_\beta) \notin L_{ext}(F)$. Otherwise, $(i_\beta, j_\beta - 1) \in L_{ext}(F)$ and $(i_\beta + 1, j_\beta) \in L_{ext}(F)$ and therefore belong to F . As $(i_\beta, j_\beta) \in L_{ext}(F)$, it belongs to F and therefore the point $(i_\beta - 1, j_\beta)$ doesn't belong to F .

$L_{ext}(F) \setminus \{(i_\beta, j_\beta)\}$ is a $\| \cdot \|_1$ connected path which connects $(i_\beta, j_\beta - 1)$ to $(i_\beta + 1, j_\beta)$.

As F is a figure without hole, there exists a $\| \cdot \|_1$ connected path which connects $(i_\beta - 1, j_\beta)$ to $(i_0, j_0 - 1)$. We extend this path adding it the point (i_β, j_β) , the points $(i_h, j_h - 1)$ for $h \in \{1, \dots, \alpha\}$ and $(i_h + 1, j_h)$ for $h \in \{\alpha, \dots, \beta - 1\}$. Then we obtain a path which connects (i_β, j_β) to $(i_\beta + 1, j_\beta - 1)$. With the lemma 2, this two paths have a common point which belongs to $L_{ext}(F) \setminus (i_\beta, j_\beta)$ and therefore to F . But, with the definition of the second path, it doesn't belong to F . There is a contradiction. \square

Lemma 4

There exists an index γ ($0 \leq \alpha \leq \beta \leq \gamma$) such that $\forall h \in \{\beta, \dots, \gamma - 1\}$, $i_{k+1} = i_k - 1$, $j_{k+1} = j_k$ and $i_{\gamma+1} = i_\gamma$ and $j_{\gamma+1} = j_\gamma - 1$.

Proof.

It is similar to the previous one (see figure 3.9). \square

Now, we have several possible cases. They are shown in the figure 3.10. Actually, the first case can readily be eliminated (because of the definition of j_0).

Lemma 5

Either $\forall k \in \{\gamma, \dots, n\}$ $i_{k+1} = i_k$, $j_{k+1} = j_k - 1$ and $(i_{k+1}, j_{k+1}) \in L_{ext}(F)$ or, $\exists \delta$ such that $\forall k \in \{\gamma, \dots, \delta - 1\}$ $i_{k+1} = i_k$, $j_{k+1} = j_k - 1$ and $i_{\delta+1} = i_\delta + 1$ and $j_{\delta+1} = j_\delta$.

Proof.

If we are in the first case, the construction is ended. We will discuss about this situation after.

Let δ be the smaller index ($\delta \geq \gamma$) such that $(i_\delta, j_\delta - 1) \notin L_{ext}(F)$. Two cases are possible: either $(i_\delta - 1, j_\delta) \in L_{ext}(F)$ or $(i_\delta + 1, j_\delta) \in L_{ext}(F)$. We show that the first case leads to a contradiction (see figure 3.11): the two points $(i_\delta + 1, j_\delta)$ and $(i_\delta, j_\delta - 1)$ don't belong to F . We call (\tilde{i}, \tilde{j}) one of these points, and we consider the two paths:

- $L_{ext}(1) \setminus (i_\delta, j_\delta)$ in F

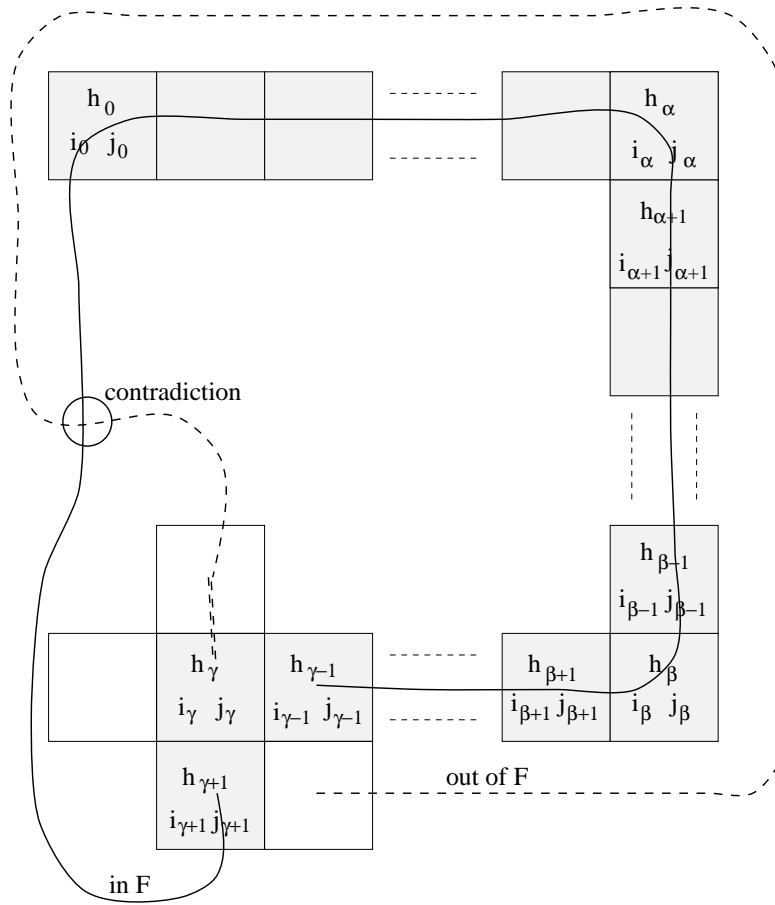

Figure 3.9: The bottom border

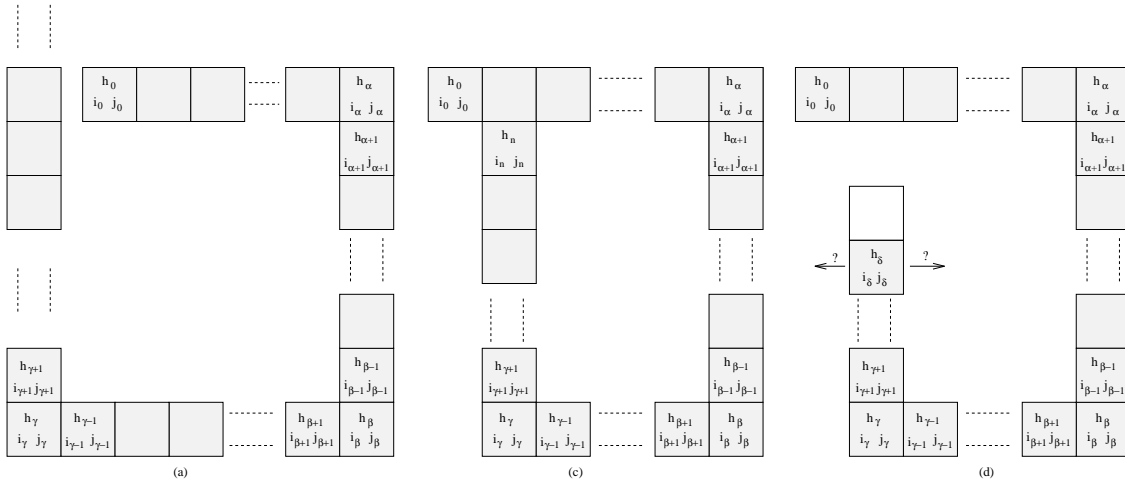

Figure 3.10: The left most border

- The path constituted with the path which doesn't belong to F and which connects (\tilde{i}, \tilde{j}) to $(i_0, j_0 - 1)$, with the point (i_δ, j_δ) and the points $(i_h, j_h - 1)$ for $h \in \{1, \dots, \alpha\}$, $(i_h + 1, j_h)$ for $h \in \{\alpha, \dots, \beta\}$ and $(i_h, j_h + 1)$ for $h \in \{\beta, \dots, \gamma\}$.

These two paths meet in a point which is not (i_δ, j_δ) and which is both in F and outside F . \square

In the case where there exists an index δ such that, for all k in $\{\gamma, \dots, \delta - 1\}$, $i_{k+1} = i_k$, $j_{k+1} = j_k - 1$, $i_{\delta+1} = i_\delta + 1$ and $j_{\delta+1} = j_\delta$ the construction of the is not ended. We continue it by induction.

There are four cases, which correspond to the four possible directions of the path (see figure 3.12).

Lemma 6

There exists a sequence of indices k_m indexed by $m \in \{0, \dots, \lambda\}$ such that:

- Si $m = 0$, $k_0 = 0$
- Si $m > 0$,
 - If $m \equiv 0 \pmod{4}$
 - * $\forall k \in \{k_{m-1}, \dots, k_m - 1\}$ $i_{k+1} = i_k$ and $j_{k+1} = j_k - 1$
 - * $i_{k_m+1} = i_{k_m} + 1$ and $j_{k_m+1} = j_{k_m}$
 - If $m \equiv 1 \pmod{4}$
 - * $\forall k \in \{k_{m-1}, \dots, k_m - 1\}$ $i_{k+1} = i_k + 1$ and $j_{k+1} = j_k$

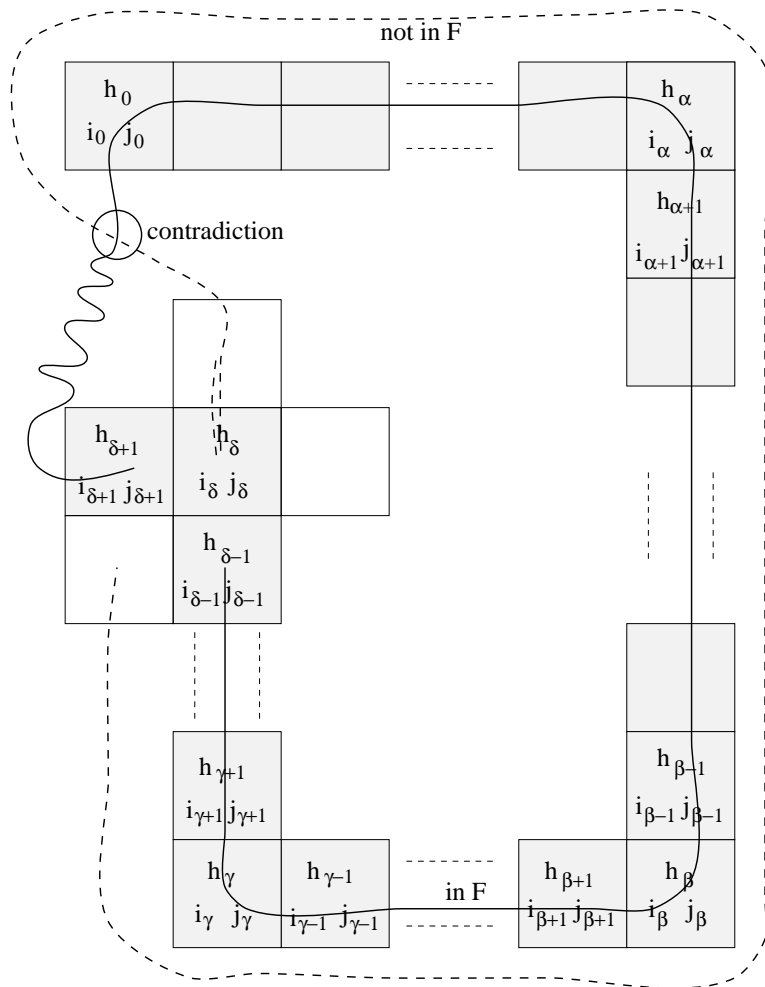

Figure 3.11: The left most border

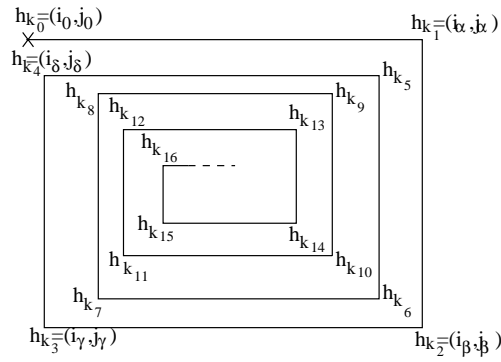

Figure 3.12: Construction of the path by induction

- * $i_{k_{m+1}} = i_{k_m}$ and $j_{k_{m+1}} = j_{k_m} + 1$
- If $m \equiv 2 \pmod{4}$
 - * $\forall k \in \{k_{m-1}, \dots, k_m - 1\}$ $i_{k+1} = i_k$ and $j_{k+1} = j_k + 1$
 - * $i_{k_{m+1}} = i_{k_m} - 1$ and $j_{k_{m+1}} = j_{k_m}$
- If $m \equiv 3 \pmod{4}$
 - * $\forall k \in \{k_{m-1}, \dots, k_m - 1\}$ $i_{k+1} = i_k - 1$ and $j_{k+1} = j_k$
 - * $i_{k_{m+1}} = i_{k_m}$ and $j_{k_{m+1}} = j_{k_m} - 1$

Proof.

Notice that the constructed path is a spiral.

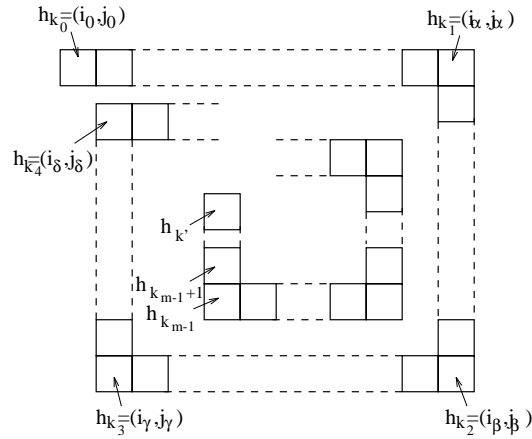

Figure 3.13: Construction of the spiral

We show this lemma by induction on m , distinguishing the different cases: $m = 0, 1, 2, 3(4)$. We have:

- For $m = 0$, $h_{k_0} = h_0 = (i_0, j_0)$ (the upper-left most cell),
- for $m = 1$ (respectively 2, 3 and 4), we have the same situation as in the lemma 2 (respectively lemma 3, lemma 4 and lemma 5) with $k_1 = \alpha$ (respectively $k_2 = \beta$, $k_3 = \gamma$, $k_4 = \delta$),

- for $m \geq 5$,

we suppose that the path h has been constructed for $k \in \{0 \dots k_{m-1} + 1\}$. We want to define it for $k \in \{k_{m-1} + 2 \dots k_m + 1\}$.

Notice that we only give the demonstration in the case where $m \equiv 0(4)$ because the other cases are similar.

- Case $m \equiv 0(4)$

With the recurrence hypothesis, we have $i_{k_{m-1}+1} = i_{k_{m-1}}$ and $j_{k_{m-1}+1} = j_{k_{m-1}} - 1$ (see figure 3.13). Let k' be the smaller index ($k' > k_{m-1}$) such that $j_{k'+1} \neq j_{k'} - 1$. In $H(i_k, j_k) \cap L_{ext}$, we have the point $(i_{k'}, j_{k'} + 1)$. As F satisfies the property P_1 , one of the two points $(i_{k'} - 1, j_{k'})$ or $(i_{k'} + 1, j_{k'}) \in L_{ext}(F) \cap H(i_{k'}, j_{k'})$. We show that if it is $(i_{k'} - 1, j_{k'})$, then we come to a contradiction (see figure 3.14). So, $(i_{k'} + 1, j_{k'})$ and $(i_{k'}, j_{k'} - 1)$ do not belong to F ; let (\tilde{i}, \tilde{j}) be one of these points.

The path I made of $L_{ext}(1)$ except $(i_{k'}, j_{k'})$, which connects $(i_{k'} - 1, j_{k'})$ to $(i_{k'}, j_{k'} - 1)$ is entirely in F .

Moreover, $(i_{k'} - 1, j_{k'} + 1)$ do not belong to $L_{ext}(F)$. So, as F is 4-connected and without hole, there exists a path CH , which is entirely outside F , and which connects (\tilde{i}, \tilde{j}) to $(i_{k'} - 1, j_{k'} + 1)$. Therefore, with the lemma 2, these two paths I and CH have a common point. This common point can't be the point (\tilde{i}, \tilde{j}) which doesn't belong to $L_{ext}(F)$. Whence the contradiction.

- Other cases.

They are similar to the former one.

□

3.2.3 Study of the path.

In this section, we study the spiral. More precisely, as we have shown that it is finite, we show that every case of stop leads to a contradiction.

We start working on the sequence of indices k_m or $m \in \{0, \dots, \lambda\}$. We show that, if we give an other formulation of this sequence, we can deduce relations between the coordinates of the points h_{k_m} (see figure 3.15).

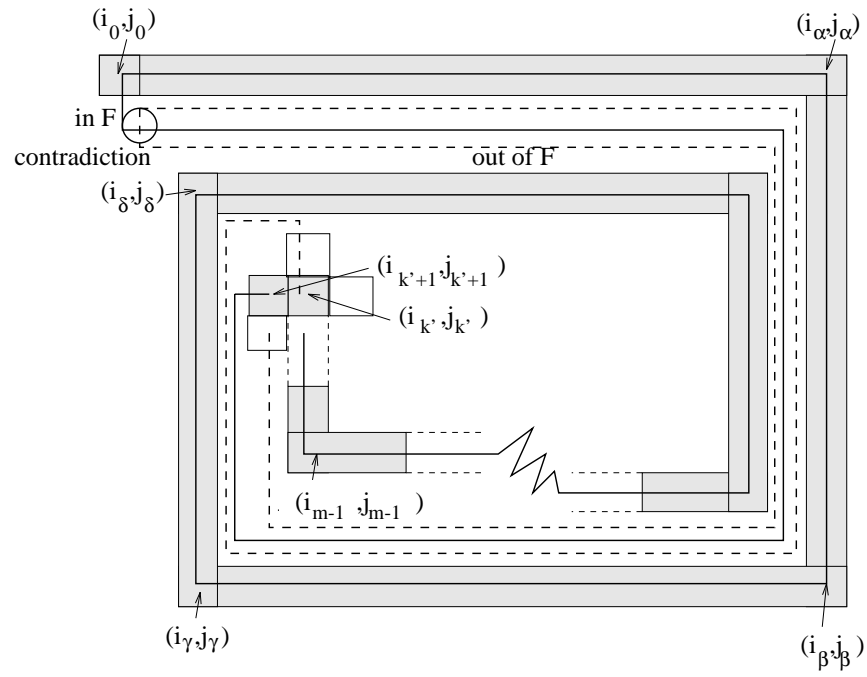

Figure 3.14: Case $m \equiv 0 \pmod{4}$

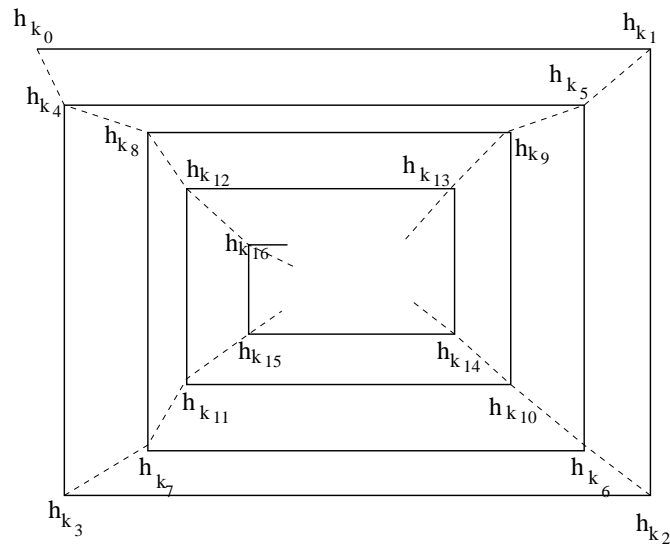

Figure 3.15: Relations between the points h_{k_m} .

Lemma 7

If $\lambda > 3$ then, nominating again the sequence k_m by $k_{0+4l}, k_{1+4l}, k_{2+4l}, k_{3+4l}$,
 $l \in \{0, \dots, \frac{\lambda-3}{4}\}$, we have:

$\forall l \in \{0, \dots, \frac{\lambda-3}{4}\}$

$$a- i_{k_{4l}} < i_{k_{4(l+1)}} < i_{k_{4(l+1)+1}} < i_{k_{4l+1}} \text{ for } l \geq 1$$

$$b- j_{k_{4l+1}} < j_{k_{4(l+1)+1}} < j_{k_{4(l+1)+2}} < j_{k_{4l+2}}$$

$$c- i_{k_{4l+2}} < i_{k_{4(l+1)+2}} < i_{k_{4(l+1)+3}} < i_{k_{4l+3}}$$

$$d- j_{k_{4l+3}} < j_{k_{4(l+1)+3}} < j_{k_{4(l+1)+4}} < j_{k_{4l+4}}$$

Proof.

We show it, by recurrence on l .

- $l=0$

We have:

$$- j_{k_1} < j_{k_5} < j_{k_6} < j_{k_2}$$

$$- i_{k_2} > i_{k_6} > i_{k_7} > i_{k_3}$$

$$- j_{k_3} > j_{k_7} > j_{k_8} > j_{k_4}$$

Effectively, $j_{k_1} = j_{k_0}$ by definition of k_1 . $j_{k_4} > j_{k_0}$ by definition of $j_0 = j_{k_0}$.

So, $j_{k_4} > j_{k_1}$. As, $j_{k_5} = j_{k_4}$ (by definition of k_5) we have $j_{k_1} < j_{k_5}$.

$j_{k_6} > j_{k_5}$ by definition of k_6 , hence $j_{k_1} < j_{k_5} < j_{k_6}$.

We prove that $j_{k_6} < j_{k_2}$ by reducing it to the absurd.

We suppose that $j_{k_6} \geq j_{k_2}$ (see figure 3.16). Then, there exists an index

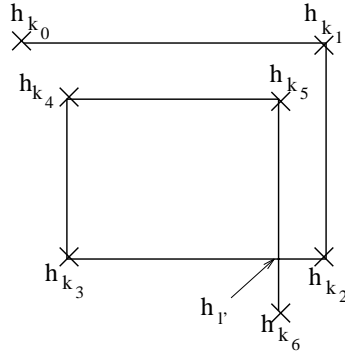

Figure 3.16: Case $j_{k_6} \geq j_{k_2}$.

$l', k_5 < l' \leq k_6$, such that $h_{l'}$ has more than two adjacent cells which belong to $L_{ext}(F)$. Hence, the contradiction.

So, we have $j_{k_1} < j_{k_5} < j_{k_6} < j_{k_2}$.

With a similar reasoning, we prove that $i_{k_2} > i_{k_6} > i_{k_7} > i_{k_3}$ and $j_{k_3} > j_{k_7} > j_{k_8} > j_{k_4}$.

• l_0

We only show the item a- because the other ones are similar.

We suppose that the relations are true for the index $(l - 1)$ (see figure 3.17).

First, we have $i_{k_{4l}} < i_{k_{4l+1}}$ by the hypothesis of recurrence .

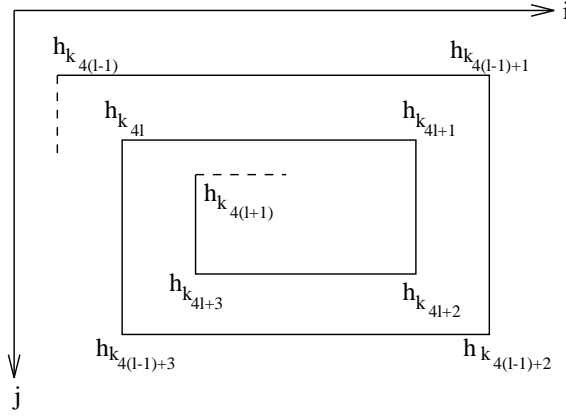

Figure 3.17: General case of the lemma 7

Moreover, $i_{k_{4l+2}} = i_{k_{4l+1}}$ by definition of $h_{k_{4l+2}}$ and $i_{k_{4l+3}} < i_{k_{4l+2}}$, hence $i_{k_{4l+3}} < i_{k_{4l+1}}$.

But, $i_{k_{4l+3}} > i_{k_{4l}}$ by the hypothesis of recurrence. Then, $i_{k_{4l}} < i_{k_{4l+3}}$.

$i_{k_{4l+4}} = i_{k_{4(l+1)}} = i_{k_{4l+3}}$ by definition of $h_{k_{4(l+1)}}$. Hence, $i_{k_{4l}} < i_{k_{4(l+1)}} < i_{k_{4l+1}}$.

Moreover, $i_{k_{4(l+1)+1}} < i_{k_{4(l+1)}}$ by the definition of $h_{k_{4(l+1)+1}}$. But, $i_{k_{4(l+1)+1}} < i_{k_{4l+1}}$ because otherwise, there exists an index l' , $k_{4(l+1)} < l' \leq k_{4(l+1)+1}$, such that $h_{l'}$ has more than two adjacent cells which belong to $L_{ext}(F)$ (see figure 3.18).

Hence, $i_{k_{4l}} < i_{k_{4(l+1)}} < i_{k_{4(l+1)+1}} < i_{k_{4l+1}}$.

□

We observe that the lemma 5 gives a possibility to stop the construction. As the figure is a finite set of cells and since the lemme 7, the sequences of points $h_{k_{0+m}}$, $h_{k_{1+m}}$, $h_{k_{2+m}}$ and $h_{k_{3+m}}$, for $m \in \{0, \dots, \lambda\}$, converge to one or two points. So, the sequence of indices k_m , for $m \in \{0, \dots, \lambda\}$ is finite. The figure 3.19 shows different possible ends of the construction.

Proposition 1

$L_{ext}(F) = \{(i, j); ((j = j_0 \text{ or } j = j_3) \text{ and } i_0 \leq i \leq i_1) \text{ or } ((i = i_0 \text{ or } i = i_1) \text{ and } j_3 \leq j \leq j_0))$

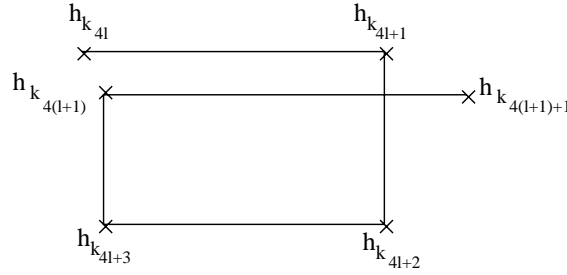

Figure 3.18: Case $i_{k_{4l+3}} > i_{k_{4l+2}}$

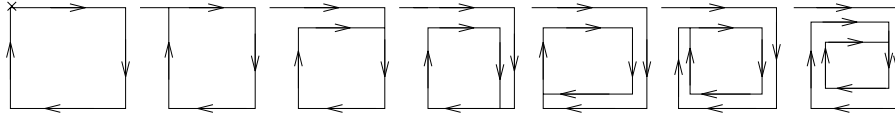

Figure 3.19: Different ends of the spiral construction

Proof.

We know that there are two kinds of stop: either the construction of the path h stops as in the situation of the first case of the lemma 5 and $i_3 > i_0$ or $i_3 = i_0$; or, it continues as in the lemma 6 and we have spiral the construction of which ends in four different case.

In fact, we can prove that every cases of stop, except the case where $i_3 = i_0$, lead to a contradiction.

Effectively, in each case there exists a cell of the path which has more than two adjacent cells which belong to $L_{ext}(F)$ (see figure 3.19).

Hence, h is the set of cells (i, j) such that $((j = j_0$ or $j = j_3)$ and $i_0 \leq i \leq i_1)$ or $((i = i_0$ or $i = i_1)$ and $j_3 \leq j \leq j_0)$ and h is the border of F . \square

3.2.4 Characterization of F .

In this section, we prove that the path which has been constructed previously is the border of a rectangle, that is to say F is a rectangle.

Proposition 2

$$F = \{(i, j); i_0 \leq i \leq i_1 \text{ and } j_3 \leq j \leq j_0\}.$$

Proof

In the former subsection, we have shown that the border of F , denoted by $L_{ext}(F)$, is such that $L_{ext}(F) = \{(i, j); ((j = j_0$ or $j = j_3)$ and $i_0 \leq i \leq i_1)$ or $((i = i_0$ or $i = i_1)$ and $j_3 \leq j \leq j_0)$. The figure 3.20 gives a graphic representation of the border of F . As F is 4-connected and without hole, F cannot only be the border of a rectangle and there not exists any cell (i, j) such

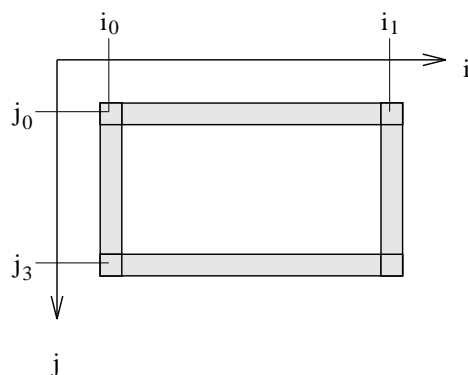
Figure 3.20: The border of F

that $i_0 \leq i \leq i_1$, $j_3 \leq j \leq j_0$ and (i, j) doesn't belong to F .
Hence, $F = \{(i, j); i_0 \leq i \leq i_1 \text{ and } j_3 \leq j \leq j_0\}$. \square

3.3 An automaton which recognizes the rectangles.

We have to find an automaton A , which allows to have, at a given time t , all the cells of the figure in the same state: the acceptance state if the figure belongs to the rectangle family or, the rejection state if the figure doesn't belong to the rectangle family.

We have shown that a figure F is a rectangle if and only if every cell that belong to the border of F have exactly two adjacent cells which belonging to the border. We use this definition in order to construct a cellular automaton recognizing the rectangles: each cell of the figure says to its neighbors whether it is on the border or not. A cell which is on the border and which has not exactly to adjacent cells on the border generates a rejection state. And, a cell which is on the border and which has exacty two adjacent cells on the border, generates an acceptance state. The proposed automaton A is $A = (2, S, H, \delta)$ such that:

- A has 5 states: $S = \{0, 1, 2, 3, 4\}$,
- H is the Von Neumann's neighborhood,
- δ is the transition function given by the transition table 3.1.

The principle is the following one. A cell which is in state 1 and that belongs to the external layer of the figure (that is to say a cell which has at least one adjacent cell in state 0) enters state 2. Afterwards, each cell which is in state

Cell	H_4^1	H_4^2	H_4^3	H_4^4	New state
1	0				2
1		0			2
1			0		2
1				0	2
2	2	2			3
2		2	2		3
2			2	2	3
2	2			2	3
2	2		2		3
2		2		2	3
2	0	0	0	0	3
$\neq 0, \neq 3, \neq 4$	3	$\neq 4$	$\neq 4$	$\neq 4$	3
$\neq 0, \neq 3, \neq 4$	$\neq 4$	3	$\neq 4$	$\neq 4$	3
$\neq 0, \neq 3, \neq 4$	$\neq 4$	$\neq 4$	3	$\neq 4$	3
$\neq 0, \neq 3, \neq 4$	$\neq 4$	$\neq 4$	$\neq 4$	3	3
2	$\neq 2$	$\neq 2$	$\neq 2$	$\neq 2$	4
2	2	$\neq 2$	$\neq 2$	$\neq 2$	4
2	$\neq 2$	2	$\neq 2$	$\neq 2$	4
2	$\neq 2$	$\neq 2$	2	$\neq 2$	4
2	$\neq 2$	$\neq 2$	$\neq 2$	2	4
$\neq 0, \neq 4$	4				4
$\neq 0, \neq 4$		4			4
$\neq 0, \neq 4$			4		4
$\neq 0, \neq 4$				4	4

Table 3.1: The transition function of the automaton recognizing the rectangle's family.

2 is going to determine, according to its neighborhood, if it may belong to the border of a rectangle. In fact, a cell which is in state 2, knows that it is not the border of a rectangle if it doesn't have exactly two adjacent cells which are in state 2. So, each cell that belongs to the border, enters the acceptance state (state 3) or in the rejection state (state 4). Then, these states spread; the rejection state is stronger than the acceptance state.

At some time t , we have:

$$\begin{aligned} \forall c \in F, \text{state}(c) &= 3 \quad (F \in \mathcal{R}) \\ \forall c \notin F, \text{state}(c) &= 4 \quad (F \notin \mathcal{R}) \end{aligned}$$

Then, we know if F is a rectangle or not.

Examples are given in the figures 3.21 and 8.1.

If all the cells of the considered figure are in state 3 then the figure is a rectangle; otherwise, if all the cells are in state 4 then the figure is not a rectangle. Let us consider the first figure. All the cells of the external layer have exactly two adjacent cells belonging to this layer, therefore they all enter the acceptance state (state 3). Afterwards, this state spreads in all the figure.

On the other hand, in the third figure, two cells of the external layer haven't exactly two adjacent cells in this layer, therefore these cells enter the rejection state. The rejection state dominates the acceptance state, so all the cells of the figure progressively enter the rejection state (state 4).

3.4 Conclusion.

We gave an automaton which allows to decide whether any 4-connected figure without hole of the discrete plane is a rectangle or not.

We can notice that four of the five states are essential: the initial states 0 and 1 and the terminal states 3 and 4 can not be suppressed. It seems that this automaton has a minimal number of states. Otherwise, it allows to detect very quickly, as soon as the second iteration, whether the figure is a rectangle and this independently regardless of its size.

For a rectangle the size of which is $m \times n$, the global recognition time is $\text{rtime}(\mathcal{R}, A) = \lceil \frac{\min(m,n)}{2} \rceil + 1$.

Chapter 4

Recognition of squares.

4.1 Introduction.

In this chapter, we study the squares' family that is to say the set of figures F such that:

$$\exists(i_0, j_0) \in \mathbb{Z}^2 \text{ and } l \in \mathcal{N} ; F = \{(i, j) \in \mathbb{Z}^2, i_0 \geq i \geq i_0 + l \text{ and } j_0 \geq j \geq j_0 + l\}$$

We are going to give an automaton which allows to recognize the squares. For this, we are going to use a similar method as the one used for the rectangles and we are going to say that a square is a rectangle which has a symmetry property. In fact, we are going to apply the idea, which has been developed by Grasselli (1975) in [Gra75], for the two-dimensional Firing Squad Problem, to the square recognition problem. Grasselli defines two operations which are applied on the figures. The first one, the decrease, consists in taking off the most external cells (that are the cells which have at least one adjacent cell which doesn't belong to the figure). The opposite operation, the expansion, consists in adding a layer of cells to the figure. If the decrease is successively applied to any figure, at a given time, if we apply one supplementary decrease, then all the cells of the figure disappear: we will say that the nucleus of the figure is reached. We will use again this idea of "peeling an onion" in order to recognize the squares.

4.2 Definition of the square.

Let F be a figure of the discrete plane.

We start from the following configuration of the plane:

$$\begin{aligned} \forall c \in F, \text{state}(c,0) &= 1 \\ \forall c \notin F, \text{state}(c,0) &= 0 \end{aligned}$$

Definition 17 (The layers of a figure)

We define the i^{th} layer of the figure F , denoted by $L_i(F)$, as follows:

- $L_0 = L_{\text{ext}}(F)$
- $i \geq 1, L_i = L_{\text{ext}}(F \setminus (L_0 \cup \dots \cup L_{i-1}))$

(See figure 4.1).

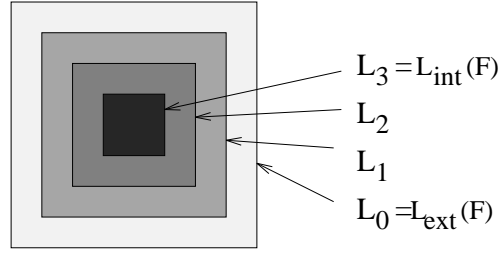

Figure 4.1: The layers of a figure.

Definition 18 (The internal layer of a figure)

As F is a finite figure, there exists an index i' such that $L_{i'+1}(F) = \emptyset$. We put $L_{\text{int}}(F) = L_{i'}(F)$. $L_{\text{int}}(F)$ is called the internal layer of the figure or the nucleus of the figure.

We define the following property, S , of a neighborhood.

Property 2

$S(H_4(x, y)) \Leftrightarrow \exists i, i', (H_4^1(x, y) \in L_i \text{ and } H_4^2(x, y) \in L_i \text{ and } H_4^3(x, y) \in L_{i'} \text{ and } H_4^4(x, y) \in L_{i'}) \text{ or } (H_4^1(x, y) \in L_i \text{ and } H_4^2(x, y) \in L_{i'} \text{ and } H_4^3(x, y) \in L_{i'} \text{ and } H_4^4(x, y) \in L_i) \text{ or } (H_4^1(x, y) \in L_{i'} \text{ and } H_4^2(x, y) \in L_{i'} \text{ and } H_4^3(x, y) \in L_i \text{ and } H_4^4(x, y) \in L_i) \text{ or } (H_4^1(x, y) \in L_{i'} \text{ and } H_4^2(x, y) \in L_i \text{ and } H_4^3(x, y) \in L_i \text{ and } H_4^4(x, y) \in L_{i'})$

If the neighborhood H_4 verify S , the cells which belong to H_4 are two-two in the same state (see figure 4.2)

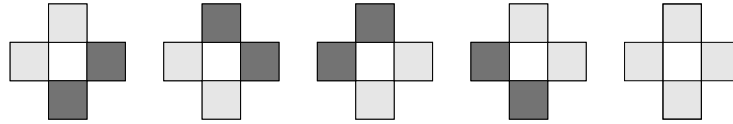

Figure 4.2: Neighborhoods that verify the property S .

For a figure F , we define the following property P_2 :

Property 3

$P_2(F) \Leftrightarrow P_1(F)$ and $(\forall(i, j) \in L_{int}(F), S(H_4(i, j)))$

F verifies P_2 if and only if F verifies P_1 , that is to say all the cells of the external layer of the figure have exactly two adjacent cells in this layer, and if the neighborhood of any cell that belongs to the nucleus of the figure verifies S .

Then, we have the following theorem:

Theorem 2

F is a square ($F \in \mathcal{S}$) $\Leftrightarrow F$ is 4-connected, without hole and $P_2(F)$ true

4.3 Demonstration.

We want to prove the former theorem.

Using the theorem 1 (chapter 3), we know that F is a rectangle, that is to say $\exists(i_0, j_0), (i_f, j_f) \in \mathbb{Z}^2, F = \{(i, j); i_0 \leq i \leq i_f \text{ and } j_0 \leq j \leq j_f\}$

Then, three cases are possible:

- Case 1: $j_f - j_0 > i_f - i_0$.
 - Case 1.1: $i_f - i_0$ odd.
As $i_f - i_0$ is odd,
 $\exists i, L_i = L_{int}(F) = R(i_0 + (i - 1), j_0 + (i - 1), i_0 + (i - 1), j_f - (i - 1)) = \{(i, j) \in F, i_0 + (i - 1) \leq i \leq i_0 + (i - 1) \text{ et } j_0 + (i - 1) \leq j \leq j_f - (i - 1)\}$
because of the definition of $L_{int}(F)$. So $L_{int}(F)$ is a rectangle the sides of which are parallel to the axis i and the length of which is 1.
Let c_1 and c_2 be the extremist cells of this rectangle, $c_1 = (i_0 + (i - 1), j_0 + (i - 1))$ and $c_2 = (i_0 + (i - 1), j_f - (i - 1))$. We have: $H_4^1(c_1) \in L_{i-1}$, $H_4^2(c_1) \in L_{i-1}$, $H_4^3(c_1) \in L_i$ et $H_4^4(c_1) \in L_{i-1}$.
Therefore, $H_4(c_1)$ doesn't satisfy the property S (it's the same for $H_4(c_2)$). Therefore P_2 is not verified in this case.
 - Case 1.2: $i_f - i_0$ even.
As $i_f - i_0$ is even,
 $\exists i, L_i(F) = L_{int}(F) = R(i_0 + (i - 1), j_0 + (i - 1), i_0 + i, j_f - (i - 1)) = \{(i, j) \in F, (i_0 + (i - 1) \leq i \leq i_0 + i \text{ and } j_0 + (i - 1) \leq j \leq j_f - (i - 1)\}$.
So $L_{int}(F)$ is a rectangle the sides of which are parallel to the axis i and the length of which is 2.
Let $c_1 = (i_0 + (i - 1), j_0 + i)$. $c_1 \in L_{int}(F)$. This cell is such that $H_4^1(c_1) \in L_i$, $H_4^2(c_1) \in L_{i-1}$, $H_4^3(c_1) \in L_i$ et $H_4^4(c_1) \in L_i$. Therefore $H_4(c_1)$ doesn't verify the property S and then, P_2 is not verified again.
- Case 2: $j_f - j_0 < i_f - i_0$

- Case 2.1: $j_f - j_0$ odd. The reasoning is the same as in the case 1.1. We obtain a rectangle the sides of which are parallel to the axis j , and the length of which is 1. And, we conclude as in 1.1.
- Case 2.2: $j_f - j_0$ even. Idem case 1.2.
- **Case 3: $i_f - i_0 = j_f - j_0$**
 Let $l = i_f - i_0 = j_f - j_0$.
 - Case 3.1: l even.
 $\exists i, L_i = L_{int}(F) = R(i_0 + (i - 1), j_0 + (i - 1), i_0 + i, j_0 + i) = \{(i, j), i_0 + (i - 1) \leq i \leq i_0 + i \text{ et } j_0 + (i - 1) \leq j \leq j_0 + i\}$. The nucleus of the figure, $L_{int}(F)$, is a square the sides of which have a length which equals 2. Therefore, it contains four cells which are named c_1, c_2, c_3 et c_4 . We have:
 - * $H_4(c_1)$ verifies S because $H_4^1(c_1) \in L_{i-1}, H_4^2(c_1) \in L_{i-1}, H_4^3(c_1) \in L_i$ and $H_4^4(c_1) \in L_i$.
 - * It's the same with $H_4(c_2), H_4(c_3)$ et $H_4(c_4)$.

Therefore P_2 is verified.

Definition 19 (The expansion of a figure)

Let $E(F)$ be the operation which is defined as follows:

- * Let $G = \{(i, j) \in F; \exists c \in H_4(i, j) \text{ and } c \in L_{ext}(F)\}$ be the set of the cells which belong to the plane and which have at least one adjacent cell in the external layer of the figure.
- * $E(F) = F \cup G$

The operation $E(F)$ consists in taking again a layer to the figure F : it's the expansion (see figure 4.3).

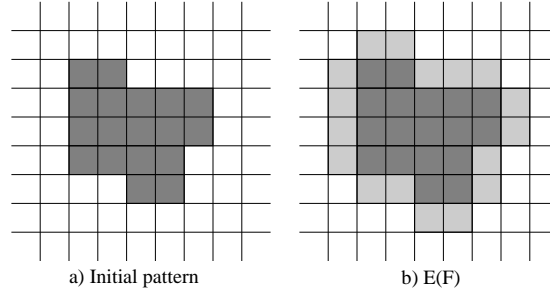

Figure 4.3: Adding a layer.

Lemma 8

If F is a square then $E(F)$ is a square.

Proof.

Let S be a square such that $S = \{(i, j) \in F, i_0 \leq i < i_0 + l \text{ and } j_0 \leq j < j_0 + l\}$. Let $T = \{(i, j) \in F,$

- * $(j = j_0 - 1 \text{ and } i \in \{i_0 - 1, \dots, i_0 + l + 1\})$
- * $(j = j_0 + l + 1 \text{ and } i \in \{i_0 - 1, \dots, i_0 + l + 1\})$
- * $(i = i_0 - 1 \text{ and } j \in \{j_0, \dots, j_0 + l\})$
- * $(i = i_0 - (l + 1) \text{ and } j \in \{j_0, \dots, j_0 + l\})$

$E(C) = C \cup T = \{(i, j) \in F; i_0 \leq i < i_0 + l \text{ and } j_0 \leq j < j_0 + l\}$

- * and $(j = j_0 - 1 \text{ and } i \in \{i_0 - 1, \dots, i_0 + l + 1\})$
- * and $(j = j_0 + l + 1 \text{ and } i \in \{i_0 - 1, \dots, i_0 + l + 1\})$
- * and $(i = i_0 - 1 \text{ and } j \in \{j_0, \dots, j_0 + l\})$
- * and $(i = i_0 - (l + 1) \text{ and } j \in \{j_0, \dots, j_0 + l\})$

Therefore $E(S) = \{(i, j) \in F, i_0 - 1 \leq i < i_0 + l + 1 \text{ and } j_0 - 1 \leq j < j_0 + l + 1\}$. Therefore $E(S)$ is a square the length of which is $l + 2$.

□

As $L_{int}(F)$ is a square, we can deduce with the lemma 8 that F is a square.

– Case 3.2: l odd .

$\exists i, L_i = L_{int}(F) = (i_0 + (i - 1), j_0 + (i - 1))$. The nucleus of the figure is reduced to an unique cell c such that: $H_4^1(c) \in L_{i-1}, H_4^2(c) \in L_{i-1}, H_4^3(c) \in L_{i-1}$ and $H_4^4(c) \in L_{i-1}$. Therefore $H_4(c)$ verify the property S (with $i' = i$) and therefore the conditions of the theorem are verified. Furthermore, $L_{int}(F)$ is reduced to a sole cell, therefore it's a square. We can deduce with the lemma 8 that F is a square.

□

4.4 An automaton which recognizes the squares.

The proposed automaton is $B = (2, S, H, \delta)$ such that:

- B has seven states: $S = \{0, 1, 2, 3, 4, 5, 6\}$,
- The neighborhood H is the Von Neumann's one,
- The transition function δ is given by the transition tables 4.1 and 4.2.
- The terminal states are the states 5 and 6 with:

$$\begin{aligned} \forall c \in F, \text{state}(c)=5 &\Leftrightarrow F \in \mathcal{S} \\ \forall c \in F, \text{state}(c)=6 &\Leftrightarrow F \notin \mathcal{S} \end{aligned}$$

Cell	H 1	H 2	H 3	H 4	New state
1	0				2
1		0			2
1			0		2
1				0	2
1	3				4
1		3			4
1			3		4
1				3	4
1	2				3
1		2			3
1			2		3
1				2	3
1	4				3
1		4			3
1			4		3
1				4	3
2	$\neq 2$	$\neq 2$	$\neq 2$	$\neq 2$	6
2	2	$\neq 2$	$\neq 2$	$\neq 2$	6
2	$\neq 2$	2	$\neq 2$	$\neq 2$	6
2	$\neq 2$	$\neq 2$	2	$\neq 2$	6
2	$\neq 2$	$\neq 2$	$\neq 2$	2	6
4	4	4	2	4	6
4	4	4	4	2	6
4	2	4	4	4	6
4	4	2	4	4	6
$\neq 0, \neq 5, \neq 6$	5	$\neq 6$	$\neq 6$	$\neq 6$	5
$\neq 0, \neq 5, \neq 6$	$\neq 6$	5	$\neq 6$	$\neq 6$	5
$\neq 0, \neq 5, \neq 6$	$\neq 6$	$\neq 6$	5	$\neq 6$	5
$\neq 0, \neq 5, \neq 6$	$\neq 6$	$\neq 6$	$\neq 6$	5	5
$\neq 0, \neq 6$	6				6
$\neq 0, \neq 6$		6			6
$\neq 0, \neq 6$			6		6
$\neq 0, \neq 6$				6	6

Table 4.1: Transition table of the automaton which recognizes the squares (2).

Cell	H 1	H 2	H 3	H 4	New state
4	4	4	3	4	6
4	4	4	4	3	6
4	3	4	4	4	6
4	4	3	4	4	6
3	3	4	3	3	6
3	3	3	4	3	6
3	3	3	3	4	6
3	4	3	3	3	6
3	4	3	4	4	6
3	4	4	3	4	6
3	4	4	4	3	6
3	3	4	4	4	6
4	3	4	3	3	6
4	3	3	4	3	6
4	3	3	3	4	6
4	4	3	3	3	6
4	2	4	2	2	6
4	2	2	4	2	6
4	2	2	2	4	6
4	4	2	2	2	6
2	0	2	0	0	6
2	0	0	2	0	6
2	0	0	0	2	6
2	2	0	0	0	6
4	2	2	2	2	5
4	4	4	2	2	5
4	2	4	4	2	5
4	2	2	4	4	5
4	4	2	2	4	5
3	4	4	4	4	5
3	3	3	4	4	5
3	4	3	3	4	5
3	4	4	3	3	5
3	3	4	4	3	5
4	3	3	3	3	5
4	4	4	3	3	5
4	3	4	4	3	5
4	3	3	4	4	5
4	4	3	3	4	5
2	0	0	0	0	5

Table 4.2: Transition table of the automaton which recognizes the squares (2).

As for the rectangles recognition, the first stage consists in putting the cells that belong to the external layer in state 2. At the second stage, each cell which belongs to this layer is going to determine, according to its neighborhood, if it is on a border of a rectangle (and possibly on a border of a square) or not. Then, after this stage, if no cell enters the error state, we are sure to have a rectangle (according to the chapter 3) and perhaps a square. Afterwards, the figure is decomposed in layers and the cells which belong to "the internal layer" (which belong to the nucleus) are able to know if they are on a square or on a rectangle. As a matter of fact, if a cell which belongs to the nucleus has a symmetrical neighborhood then it is on a square. This is true because if we take off the external layer of a square we obtain an other square. On the other hand, if such a cell has not a symmetrical neighborhood then it is not on a square. See figure 8.2.

4.5 Conclusion.

We proved that the automaton, which is given above, allows to recognize the squares.

The global recognition time is $rtime(\mathcal{S}, B) = \lceil \frac{n}{2} \rceil + 1$ where n is the distance between the farthest cells in the figure.

Chapter 5

Recognition of patterns which are built with rectangles.

In the chapter 3, we have seen that a rectangle is recognizable with plane cellular automata. Now, we consider families of figures which are built with rectangles (families of characters). They are globally defined. In order to recognize these figures, the question is to count the number retracting vertexes that the figure has.

5.1 Definitions

5.1.1 Coming out and retracting vertexes

Definition 20 (Coming out vertex)

*Let $(x, y) \in F$. We say that (x, y) is a **coming out vertex of the figure F** if and only if there exists $(x', y') \in H_4(x, y)$ and $(x'', y'') \in H_4(x, y)$ ($x'' \neq x'$ and $y'' \neq y'$) such that $(x', y') \notin F$ and $(x'', y'') \notin F$.*

See figure 5.1.

Definition 21 (Retracting vertex)

*Let $(x, y) \in F$. We say that (x, y) is a **retracting vertex of the figure F** if and only if there exists $(x', y') \in H_4(x, y)$ and $(x'', y'') \in H_4(x, y)$ ($x'' \neq x'$ and $y'' \neq y'$) such that $(x', y') \in F$ and $(x'', y'') \in F$ and there exists (x''', y''') in $H_4(x', y')$ and in $H_4(x'', y'')$ such that $(x''', y''') \notin F$.*

See figure 5.2.

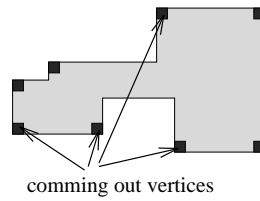

Figure 5.1: Coming out vertices of a figure.

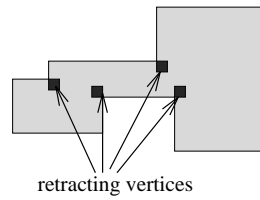

Figure 5.2: Retracting vertices of a figure.

Definition 22 (Vertex of a figure)

Let $(x, y) \in F$. (x, y) is a vertex of F if and only if (x, y) is a coming out vertex or a retracting vertex.

5.2 Recognition of "L".

5.2.1 Definition of the \mathcal{L} family.

A figure is a "L" if and only if it has five vertexes and therefore, one and only one retracting vertex (see figure 5.3).

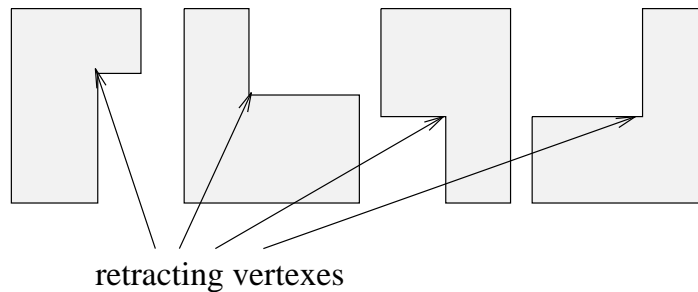

Figure 5.3: Examples of "L".

We are going to define more precisely the "L" family: \mathcal{L} . We consider the Von Neumann's neighborhood.

Definition 23

Let $F_1 = R(i_0, j_0, i_f, j_f) = \{(i, j), i_0 \leq i \leq i_f \text{ and } j_0 \leq j \leq j_f\}$.

Let $F_2 = R(i'_0, j'_0, i'_f, j'_f) = \{(i, j), i'_0 \leq i \leq i'_f \text{ and } j'_0 \leq j \leq j'_f\}$ such that:

- $(i'_0, j'_0) = (i_0, j_0)$ or $(i'_f, j'_0) = (i_f, j_0)$ or $(i'_f, j'_f) = (i_f, j_f)$ or $(i'_0, j'_f) = (i_0, j_f)$
- $(i'_f - i'_0) < (i_f - i_0)$ and $(j'_0 - j'_f) < (j_0 - j_f)$

$$\mathcal{L} = \{F \subset \mathbb{Z}^2, F = F_1 \setminus F_2\}$$

See figure 5.4.

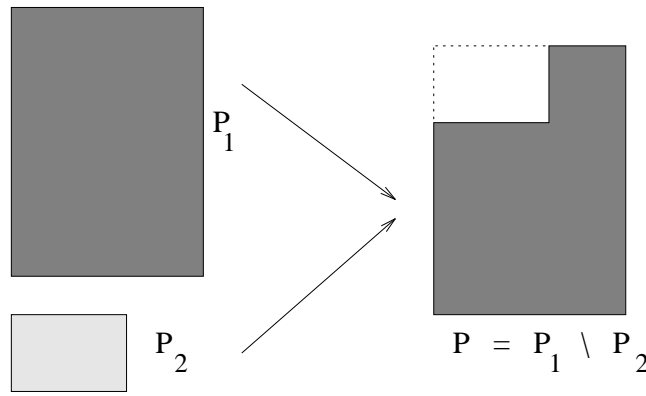

Figure 5.4: Definition of the "L".

5.2.2 Automaton which recognizes \mathcal{L} .

In order to know if any figure belongs to \mathcal{L} , or not, we have to know if the figure has exactly one retracting vertex.

The proposed automaton is $L = (2, S, H, \delta)$ such that:

- * L has 10 states: $S = \{0, 1, 2, 3, 4, 5, 6, 7, 8, 9\}$,
- * The neighborhood H is the Von Neumann's one,
- * The transition function δ is given by the transition table in appendix, chapter 4.

Principle:

- * At first, the borders of the figure are marked: the cells which are concerned (the ones that have at least one adjacent cell in the state 0) enter in the state 2.
- * A second and third times, we differentiate the retracting vertexes: two different states are used in order to distinguish the retracting vertexes (see figure 5.5).

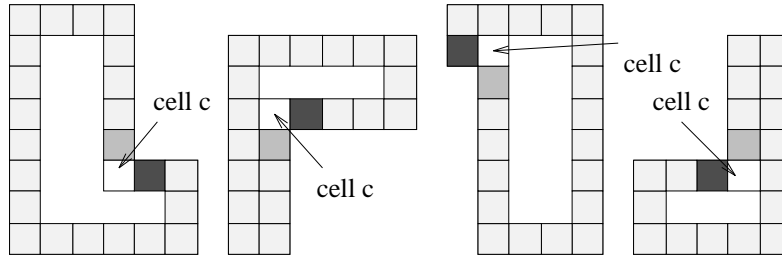

State 2
 State 3
 State 4

A cell which is in the state 2, which has a unique adjacent cell in the state 2 and which is on a vertical border enters in the state 3. A cell which is in the state 2, which has a unique adjacent cell in the state 2 and which is on an horizontal border enters in the state 4.

This generates four possible neighborhood for the cell c . Then, this cell enters in a different state according to its neighborhood (this state is propagated...).

Figure 5.5: How differentiate the retracting vertexes.

- * Afterwards, the states of the angles spread:
 - If two different states meet then the figure has several retracting angles and it doesn't belong to \mathcal{L} .
 - Otherwise, at a given moment, all the cells of the figure are in the same state (the one that has been propagated since the unique angle) and $F \in \mathcal{L}$.

In order to solve the problem that occurs when the figure has no retracting angle (case of the rectangle), the state 2 is propagated and if, at a given moment, all the cells of the figure are in the state 2 then the figure is not a \mathcal{L} (see figures 8.3).

5.2.3 Automaton which recognizes the "L" family using cells that are outside the figure.

We can notice that the utilization of cells that are outside the figure facilitates the recognition and in particular, reduces the number of states that are necessary. So, a possible automaton $L' = (2, S, H, \delta)$ is such that:

- L' has 8 states: $S = \{0, 1, 2, 3, 4, 5, 6, 7\}$,
- H is the Von Neumann's neighborhood,
- The transition function δ is given in appendix, chapter 4.

The principle is exactly the same as previously but a cell that is in a retracting angle (therefore, which is outside the figure) knows right away the existence of this angle and therefore, it's not necessary to use two different states in order to distinguish the angles (see figure 5.6 and 8.4).

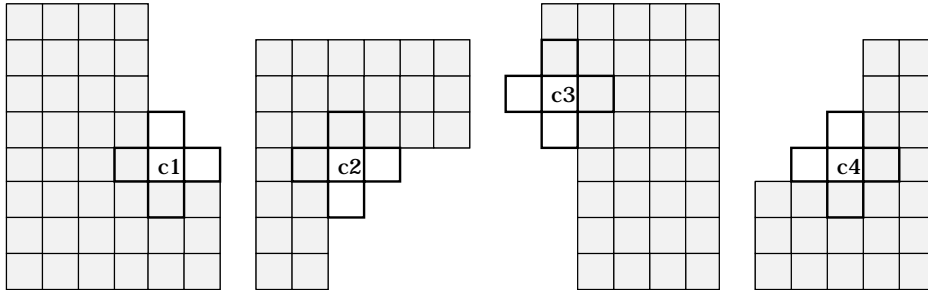

Les cellules c_1 , c_2 , c_3 et c_4 ont des voisinages différents. Elles peuvent donc entrer dans des états différents; qui se propageront ensuite à l'intérieur de la figure.

The cells c_1 , c_2 , c_3 and c_4 have different neighborhoods. So, they can enter in different states which will spread afterwards inside the figure.

Figure 5.6: Utilization of cells that are outside the figure.

5.3 Recognition of "U".

5.3.1 Definition of the \mathcal{U} family.

A figure is a "U" if and only if, when we direct the border of the figure and we go over it, we meet exactly six vertexes and two successive retracting vertexes (see figure 5.7).

We are going to define more precisely the "U" family: \mathcal{U} .
The utilized neighborhood is the Von Neumann's one.

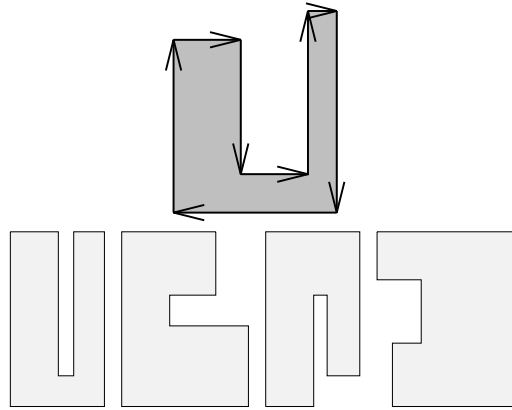

Figure 5.7: Examples of "U".

Definition 24

Let $F_1 = R(i_0, j_0, i_f, j_f) = \{(i, j), i_0 \leq i \leq i_f \text{ and } j_0 \leq j \leq j_f\}$ and $F_2 = R(i'_0, j'_0, i'_f, j'_f) = \{(i, j), i'_0 \leq i \leq i'_f \text{ and } j'_0 \leq j \leq j'_f\}$ such that:

- $(i'_f - i'_0) < (i_f - i_0)$ and $(j'_f - j'_0) < (j_f - j_0)$
- $i'_0 = i_0$ or (exclusive) $j'_0 = j_0$ or (exclusive) $i'_f = i_f$ or (exclusive) $j'_f = j_f$

$$\mathcal{U} = \{F \subset \mathbb{Z}^2, F = F_1 \setminus F_2\}$$

In order to recognize this model of figures, it's necessary to verify that the figure has exactly two retracting vertexes and that these vertexes are well placed (this is in order to distinguish the "U" and the figures that are shown in the figure 5.8).

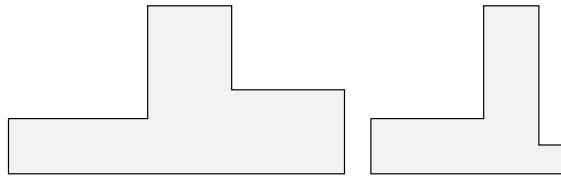

Figure 5.8: Examples of figures that don't belong to \mathcal{U} .

5.3.2 Automaton which recognizes the "U".

The idea is the following one: we start marking all the cells of the external layer. Among these cells, if there exist some that have an unique adjacent cell in the external layer then they enter in a state which depends on the place they

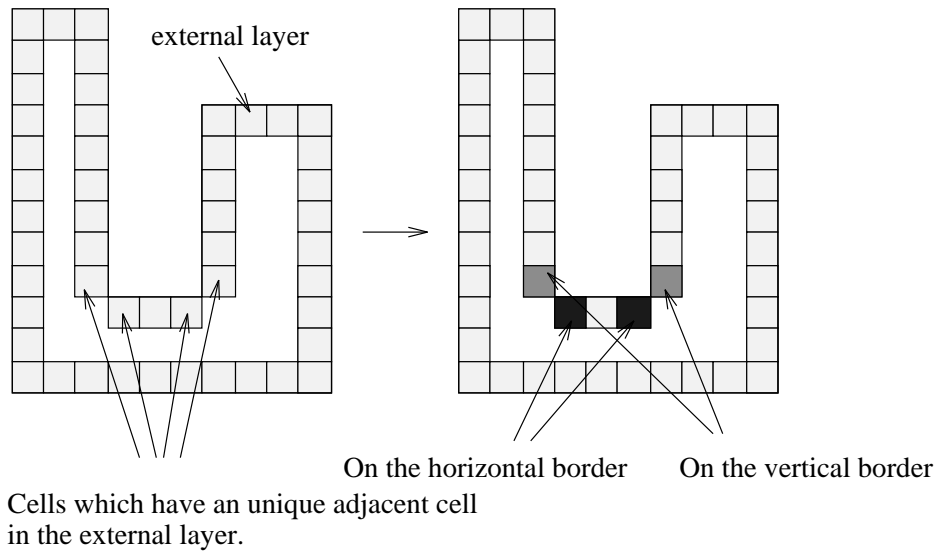

Figure 5.9: Marking the retracting angles.

are (on the horizontal or vertical border). This is shown in the figure 5.9. We can distinguish the different angles (as in the recognition of "L"). The states that correspond are propagated. In the case where there is an unique retracting angle, all the cells of the figure will enter in the state of the angle. So, we will say that the figure is not a "U".

In the case where there are two retracting angles, the corresponding states will meet. We have now two possibilities: either we have a "U" or we have a "T". In the first case, the states which are propagated will meet "as it is necessary" that is to say the meeting direction is respected. Then a state "YES" is generated. In the second case, a state "NO" is generated (see figure 5.10). In the case

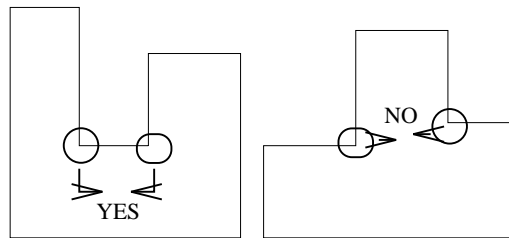

Figure 5.10: Meeting of two states.

where there are three retracting angles, or more then that, the meeting of an other state causes the generation of a state "NO". The automaton is given in

appendix, chapter 4. See figure 8.5.

5.3.3 Automaton which recognizes the \mathcal{U} family using cells that are outside the figure.

As in the recognition of "L", we notice that if we allow the utilization of cells that are outside the figure then it's possible to find a simpler automaton which has, in particular, less states.

A possible automaton is given in appendix, chapter 4.

5.4 Recognition of "O".

5.4.1 Definition of the \mathcal{O} family.

A figure is a "O" if and only if it's a rectangle with a rectangular hole (see figure 5.11).

The utilized neighborhood is Von Neumann's one.

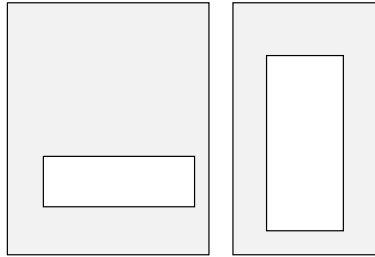

Figure 5.11: Examples of "O".

Definition 25

Let $F_1 = R(i_0, j_0, i_f, j_f) = \{(i, j), i_0 \leq i \leq i_f \text{ and } j_f \leq j \leq j_0\}$.

Let $F_2 = R(i'_0, j'_0, i'_f, j'_f) = \{(i, j), i'_0 \leq i \leq i'_f \text{ and } j'_f \leq j \leq j'_0\}$ with:

- $i'_0 > i_0$
- $i'_f < i_f$
- $j'_0 < j_0$
- $j'_f > j_f$

$$\mathcal{O} = \{F \subset \mathbb{Z}^2, F = F_1 \setminus F_2\}$$

5.4.2 Automaton which recognizes the "O".

The principle is still the same. We propagate the states of different retracting angles, we count if they are really four and we verify that the states meet "as it is necessary" (see figure 5.12).

The automaton is given in appendix, chapter 4. See figure 8.6.

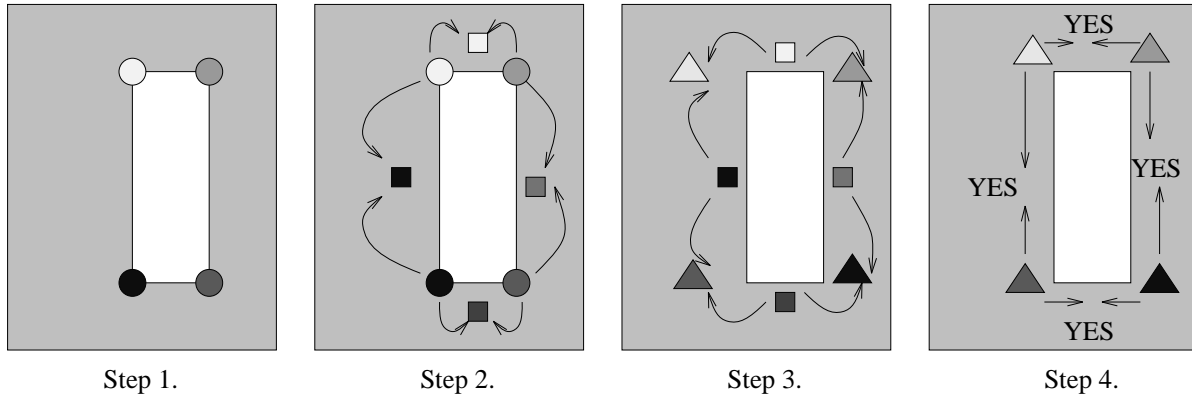

- Step 1: Generation of states that correspond to the different retraction angles.
- Step 2: Propagation of these states. When they meet, there is generation of new states which means: "two different angles have meet".
- Step 3: Propagation of these states. Their meeting generate new states which means: "three different angles have meet".
- Step 4: New propagation and new states "four different angles have meet".

Figure 5.12: Recognition of "O".

5.5 Recognition of "T".

Previously, we cast about recognizing figures built from a rectangle which is subtracted with different manners to another one. Likewise, we can look for recognizing figures which are the result of the subtraction of two rectangles. Then, we obtain figures that are similar of the ones that are presented in 5.13.

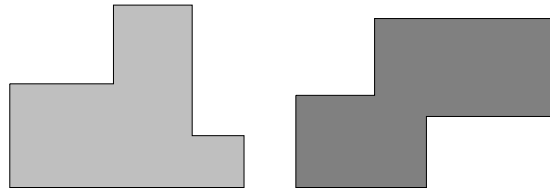

Figure 5.13: Subtraction of two rectangles.

5.5.1 Definition of the "T" family: \mathcal{T} .

Here, we are interesting in the \mathcal{T} family but the other ones that are built from the subtraction of two rectangles would be recognizable with similar automata. A figure is a "T" if and only if it has exactly 6 vertexes and two retracting vertexes (separated by two vertexes if we go over the oriented border of the figure). See figure 5.14.

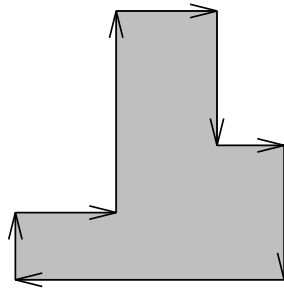

Figure 5.14: Recognition of "T".

Definition 26

Let $F_1 = R(i_0, j_0, i_f, j_f) = \{(i, j), i_0 \leq i \leq i_f \text{ and } j_0 \leq j \leq j_f\}$.

Let $F_2 = R(i'_0, j'_0, i'_f, j'_f) = \{(i', j'), i'_0 \leq i' \leq i'_f \text{ and } j'_0 \leq j' \leq j'_f\}$ such that:

- $(i'_0, j'_0) = (i_0, j_0)$ or (exclusive) $(i'_f, j'_0) = (i_f, j_0)$ or (exclusive) $(i'_f, j'_f) = (i_f, j_f)$ or (exclusive) $(i'_0, j'_f) = (i_0, j_f)$
- $(i'_f - i'_0) < (i_f - i_0)$ and $(j'_f - j'_0) < (j_f - j_0)$

Let $F_3 = R(i''_0, j''_0, i''_f, j''_f) = \{(i'', j''), i''_0 \leq i'' \leq i''_f \text{ and } j''_0 \leq j'' \leq j''_f\}$ such that:

- $(i''_0, j''_0) = (i_0, j_0) \neq (i'_0, j'_0)$ or (exclusive) $(i''_f, j''_0) = (i_f, j_0) \neq (i'_f, j'_0)$ or (exclusive) $(i''_f, j''_f) = (i_f, j_f) \neq (i'_f, j'_f)$ or (exclusive) $(i''_0, j''_f) = (i_0, j_f) \neq (i'_0, j'_f)$
- $(i''_f - i''_0) < (i_f - i_0)$ and $(j''_f - j''_0) < (j_f - j_0)$

- $P_2 \cap P_3 = \emptyset$

$$\mathcal{T} = \{F \subset \mathbb{Z}^2, F = F_1 \setminus (F_2 \cup F_3)\}$$

5.5.2 Automaton which recognizes the "T".

The principle is the same as the one that is used in the "U" recognition. The border of the figure is marked. The different retracting vertex are distinguished. The corresponding states are propagated... The automaton is given in appendix, chapter 4. See figure 8.5.

5.6 Generalization.

Here, we define a family of figures which contains some of the families that have been studied before, and which is recognizable with 2-dimensional cellular automata.

Let F be a 4-connected figure without hole.

5.6.1 Encoding of a figure

Definition 27 (Encoding of a vertex)

Let (x, y) be a vertex of the figure. We define the encoding of (x, y) , denoted by $c(x, y)$, as follows:

- $c(x, y) = 1$ if and only if (x, y) is a coming out vertex of F ,
- $c(x, y) = -1$ if and only if (x, y) is a retracting vertex of F .

Let $y_0 = \min(y, (x, y) \in F)$ and $x_0 = \min(x, (x, y_0) \in F)$. (x_0, y_0) is the upper-left most cell of the figure F .

Lemma 9

(x_0, y_0) is a coming out vertex of F .

Proof

$(x_0, y_0 - 1) \notin F$ by definition of y_0 and $(x_0, y_0 - 1) \in H_4(x_0, y_0)$.

$(x_0 - 1, y_0) \notin F$ by definition of y_0 and $(x_0 - 1, y_0) \in H_4(x_0, y_0)$. □

Definition 28 (Encoding of a figure)

Let F be a 4-connected figure, without hole and which has p vertices.

We define the encoding of F , denoted by $C(F)$, as follows:

$$C(F) = (m_1, \dots, m_p)$$

with:

- $m_1 = c(x_0, y_0) = 1$,
- m_i ($i \geq 2$) is the encoding of the i -th vertex of the figure F when we go round the border of the figure in the counterclockwise direction since the upper-left most cell.

See figure 5.15.

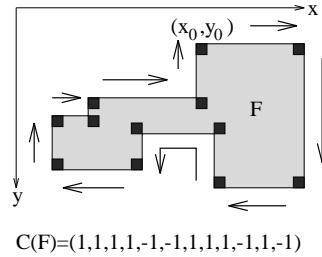

Figure 5.15: Encoding of a figure.

Now, we define an operation, denoted by OP_1 , on the encoding of a figure.

Definition 29 (Operation on the encoding of a figure)

We suppose that F has p vertices. OP_1 is such that:

$$OP_1 : \{0, 1\}^p \rightarrow \{0, 1\}^p$$

$$C(F) = (m_1, \dots, m_p) \mapsto C'(F) = (m'_1, \dots, m'_{p+2}) \text{ such that:}$$

Let $i \in \{1, \dots, p\}$ such that $m_i = 1$. For all j in $\{1, \dots, i-1\}$, $m'_j = m_j$, $m'_i = -1$, $m'_{i+1} = 1$, $m'_{i+2} = -1$ and for all j in $\{i+3, \dots, p+2\}$, $m'_j = m_{j-2}$.

In fact, the operation OP_1 change a coming out vertex of the figure into three vertices: a retracting, a coming out and a retracting vertex.

5.6.2 A more general family of figure

Let \mathcal{F} be the family of figures which is defined as follows: Let $R = \{(x, y) \in \mathbb{Z}^2; \exists x_0, y_0, x_f, y_f \in \mathbb{Z} \text{ such that } x_0 \leq x \leq x_f \text{ and } y_0 \leq y \leq y_f\}$. R is a rectangle and $C(R) = (1, 1, 1, 1)$.

- $\mathcal{F}^{(0)} = \{R\}$,
- $\mathcal{F}^{(i+1)} = \mathcal{F}^{(i)} \cup \{F \in \mathbb{Z}^2 \text{ such that } \exists F' \in \mathcal{F}^{(i)}, C(F) = OP_1(C(F'))\}$

$$\mathcal{F} = \cup_{i=0}^n \mathcal{F}^{(i)}$$

This family of figures is recognizable with 2-dimensional cellular automata. The recognition algorithm has two steps:

- The first step consists in dividing the considered figure as it is shown in the figure 5.16.

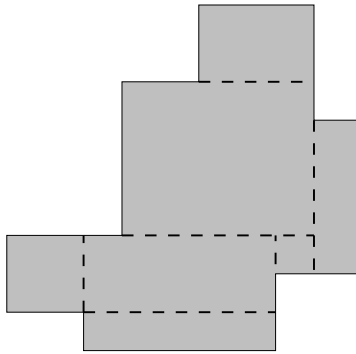

Figure 5.16: Division of the figure.

- The second step must allow to verify if the different parts of the figure that are obtained are rectangles.

It would be necessary to develop it.

5.7 Conclusion

In this chapter, we have defined family of figures since the rectangles' family. There are recognizable with 2-dimensional cellular automata and their recognition algorithm has to be studied more precisely.

Chapter 6

Recognition of ellipses.

6.1 Introduction.

In this part, we want to recognize ellipses. We use waves which spread into the figure.

Before giving an automaton which allows to do this work, we define the discrete ellipse.

An ellipse is the set of points, the sum of distance of which, to two particular points called (**the focuses**), is constant. The ellipse is called *4-ellipse* if the considered distance is d_4 and *8-ellipse* if the considered distance is d_8 .

In the discrete plane (\mathbb{Z}^2), we consider two particular cells, which will to be the focuses of the ellipse. Since these focuses, we compute for each cell of the plane the sum of the distances between itself and the focuses. The figure 6.1 shows this computation since focuses aligned or not, with d_4 .

Let s be an integer. Therefore, an ellipse is formed with cells the sum of distances between itself and the focuses of which, is less or equal to s (see figure 6.2).

Now, we are going to give a more formal definition of the discrete ellipse.

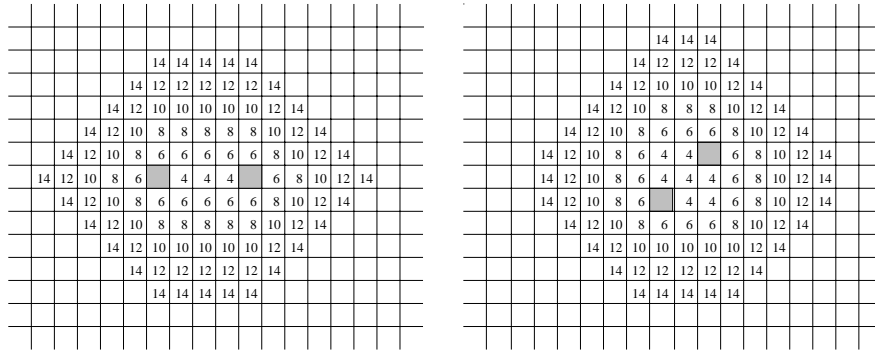

■ Focus

i: distance between the cell and the two focus.

Figure 6.1: Sum of distances (focus aligned or not).

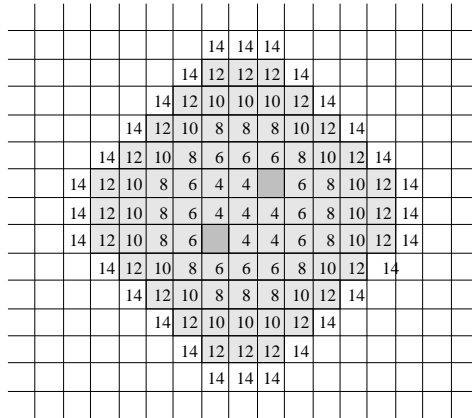

■ Cell which belongs to the ellipse.

Figure 6.2: Example of ellipse ($s=12$, $d = d_4$).

Definition 30

Let f_1 and f_2 be two given cells of the discrete plane. Let s be an integer.

We say that E is the ellipse the focuses of which are f_1 and f_2 and the distance of which is s if and only if $E = E(f_1, f_2, s) = \{(x, y) \in \mathbb{Z}^2, d(c, f_1) + d(c, f_2) \leq s\}$ where $d = d_4$ or d_8 .

To each cell c of the discrete plane (\mathbb{Z}^2) is assigned a sum of distances $s(c)$ such that $s(c) = \sum_{i=1}^2 d(c, f_i)$.

Let \mathcal{E} be the family of ellipses and let $c \in \mathbb{Z}^2$.

$$P \in \mathcal{E} \Leftrightarrow \exists s \in \mathbb{N}^*, \forall c \in \mathbb{Z}^2, s(c) \leq s$$

6.2 An automaton which recognizes the 4-ellipses.

The automaton that we must built, must allow to verify: $\exists s \in \mathbb{N}^*, \forall c \in \mathbb{Z}^2, s(c) \leq s$. More exactly, it must allow to verify that all the cells which belong to the border of the ellipse have a sum of distances which is equal.

The idea is to make a wave coming from one of the focuses, in all the possible directions. This wave spreads as far as touching the border of the ellipse. Then, the cells which are on the border, send back a wave (different from the first one). This wave spreads to the second focus. Then, verify that the figure is an ellipse consists in verifying that the second wave "faints" at the second focus. So, we verify that the sum of the distances of any cell of the border to the two focuses is constant.

The proposed automaton is $E = (2, S, H, \delta)$ where:

- E has seven states: $S = \{0, 1, 2, 3, 4, 5, 6\}$,
- H is the Von Neumann's neighborhood,
- The transition function is given by the transition table given in appendix, chapter 5.

(See figure 8.7).

The space-time diagram which corresponds to this automaton is given in figure 8.8.

6.3 Demonstration.

Here, we intend to prove that the automaton which has been proposed recognizes the ellipses and only them.

Definition 31 (Plane 4-wave centered on a cell)

Let c be a cell. A plane 4-wave centered on c , denoted by $W_c^{(4)}$, is defined as follows:

- If $t = 0$, $W_c^{(4)}(t = 0) = c$
- $\forall t \geq 1$, $W_c^{(4)}(t) = W_c^{(4)}(t-1) \cup E^{(4)}(t-1)$ with $E^{(4)}(t-1) = \{(i, j) \in \mathbb{Z}^2, (i, j) \notin W_c^{(4)}(t-1), \exists e \in W_c^{(4)}(t-1) (i, j) \in H_4(e)\}$
 $E^{(4)}(t-1)$ is the set of the cells which are 4-adjacent to $W_c^{(4)}(t-1)$.

See figure 6.3

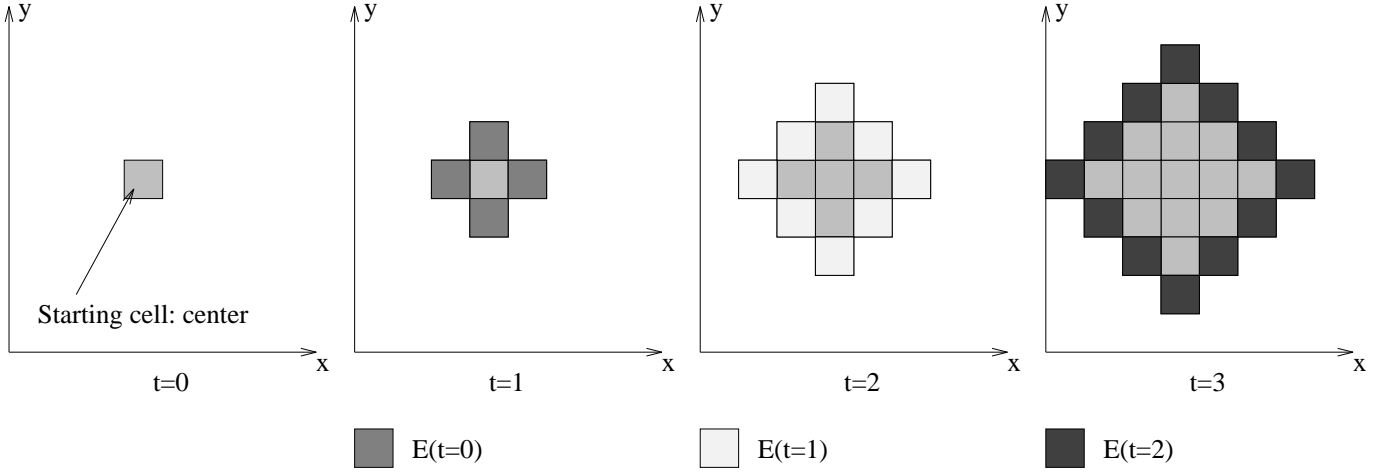

Figure 6.3: Definition of the plane 4-wave.

Let $R^{(4)}(t) = \{(i, j); (i, j) \in (W_{f_1}^{(4)} \cap L_{ext}(F))\}$ be the set of cells that belong both, at time t , to the external layer of the figure and to the 4-wave which is emitted by f_1 .

Definition 32 (Plane 4-wave centered on a cell which propagates in a figure)

Let c be a cell and F be a figure. A plane 4-wave centered on c propagates in the figure F (we denote it by $W_{c,F}^{(4)}$) if and only if:

- $W_{c,F}^{(4)}(t = 0) = c$
- $W_{c,F}^{(4)}(t) = W_{c,F}^{(4)}(t-1) \cup E'^{(4)}(t-1)$ with $E'^{(4)}(t-1) = \{(i, j) \in F, (i, j) \notin W_{c,F}^{(4)}(t-1), \exists e \in W_{c,F}^{(4)}(t-1) (i, j) \in H_4(e)\}$

Let $c \in L_{ext}(F)$. We denote by $U^{(4)}(t) = \cup_{\tau \leq t} (W_{c,F}^{(4)})$ the set of waves that are emitted by the cells that are on the border of the figure, at time t .

We define the property P_3 of F as follows:

Property 4 $P_3(F) \Leftrightarrow \exists t > 0, \exists!(i, j) \in F, (i, j) \notin U^{(4)}(t)$ and $(i, j) = f_2$
 A figure F verify the P_3 property if and only if, at a given moment t there exists an unique cell which is not reached by the union of the waves the centers of which are the border of the figure.

The theorem that we want to prove is the following one:

Theorem 3

Any 4-connected figure F , without hole, which has two particular cells f_1 and f_2 and which verify the P_3 property is a 4-ellipse, that is to say:

$$\exists s \in \mathbb{N}^*, F = \{c \in \mathbb{Z}^2; d(c, f_1) + d(c, f_2) \leq s\}$$

Before showing this theorem, we introduce a lemme which will be usefull.

Lemma 10

All the cells which are located to a distance d from the center c of a wave $W'_{c,F}$, are reached at the same time t by this wave and $t = d$.

Proof.

This is due both to the definition of the wave and to the definition of the Von Neumann's neighborhood. \square

Proof of the theorem.

Let $t_1 = \min_t(R(t) \neq \emptyset)$ be the necessary time for the wave to reach the nearest border.

With the lemma 9, the cells that are reached at the time t_1 are the cells located at a distance $d_1 = t_1$ from f_1 .

Let $t_2 > t_1$ and $t_2 = \max_t(R(t) \neq \emptyset)$ be the necessary time for the wave to reach the cells that are on the farthest border from f_1 . These cells are $d_2 = t_2$ away from f_1 .

Each cell c , that is on the border of the figure, which is reached between t_1 and t_2 is itself the center of a new wave (see figure 6.4). Therefore, we have:

- At $t = t_1 + 1$, each cell c of $R(t_1)$ generate a wave $W'_{c,F}$
- At $t = t_2 + 1$, each cell c of $R(t_2)$ generate too a wave $W'_{c,F}$

According to the P_3 property, these waves faint at the same time $t = t'$.

Let $t'_1 = t' - (t_1 + 1)$ be the necessary time for a wave which is generated at $t_1 + 1$ to faint. Likewise, let $t'_2 = t' - (t_2 + 1)$ be the necessary time for a wave which is generated at $t_2 + 1$ to faint.

We call f_2 the cell on which the generated waves faint.

Then, we have $t_1 + 1 + t'_1 = t_2 + 1 + t'_2$ as the P_3 property is verified. Therefore, $t_1 + t'_1 = t_2 + t'_2$. With the lemma 9, we have $d_1 + d'_1 = d_2 + d'_2$ where d'_1 is the distance between the cells that are nearest from f_1 and f_2 , and d'_2 is the distance between the cells that are farthest from f_1 and f_2 .

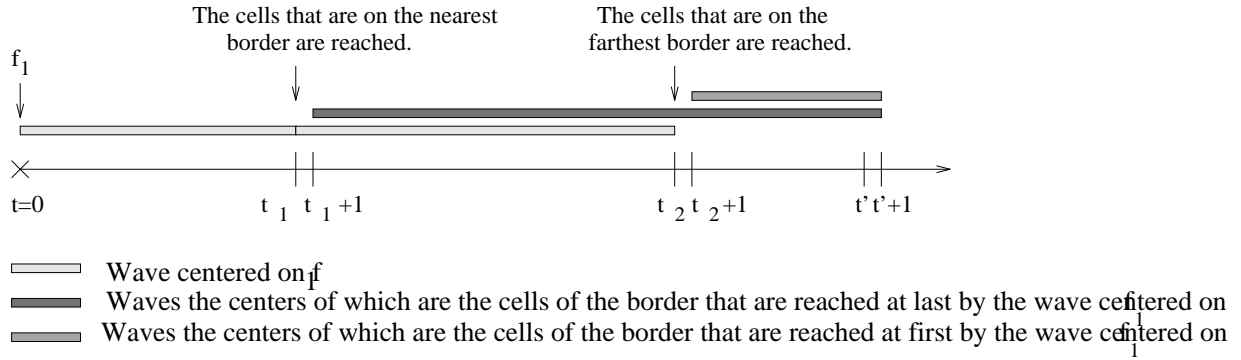

Figure 6.4: Repartition of the different wavetime.

Lemma 11

$\forall c \in L_{ext}(F), d_c + d'_c = d_1 + d'_1 = d_2 + d'_2$ with $d_c = d(c, f_1)$ and $d'_c = d(c, f_2)$

Proof.

Let c be any cell of the border of F . This cell is reached at t_c by the wave centered on f_1 . We have: $t_1 \leq t_c \leq t_2$, that is to say this cell is d_c away from f_1 , with $d_1 \leq d_c \leq d_2$.

As F verify P_3 , we have: $t_c + t'_c = t_1 + t'_1 = t_2 + t'_2$ where t'_1 is the necessary time for the wave centered on c to faint in f_2 . Therefore, $d_c + d'_c = d_1 + d'_1 = d_2 + d'_2$ where d'_2 is the distance between c and f_2 . \square

Therefore, we have a $\| \cdot \|_1$ connected figure, without hole, which has two particular cells f_1 and f_2 and such that any cell c of the border of the figure verify $d_c + d'_c = s$ where s is a constant. Therefore, this figure is an ellipse which has two focuses f_1 and f_2 , and such that $F = \{c \in \mathbb{Z}^2, d(c, f_1) + d(c, f_2) \leq s\}$.

6.4 Particular cases.

6.4.1 Case where the focuses are merged.

Definition.

In this part, we deal with the particular case where the focuses are merged. So, we have figures which are similar to the one which is shown in the figure 6.5

Definition 33

A figure F is an ellipse the focuses of which are merged if and only if $\forall c \in F, s(c) \leq \text{constante}$ with $s(c) = d(f, c)$.

Let \mathcal{C} be the corresponding family.

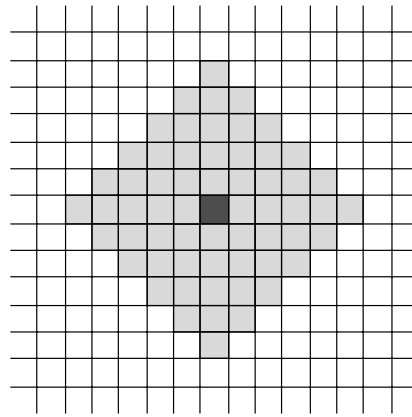

Figure 6.5: Ellipse the focuses of which are merged.

An automaton which recognizes the 4-ellipses the focuses of which are merged.

The automaton must verify that all the cells of the border of the figure are at the same distance from the focuses. In fact, the question is to make an automaton which is similar to the one that has been proposed for the recognition of ellipses where the unique focus acts the part of the two previous ones. So, it initiates the first wave and must verify that the second one comes back from all quarters at the same moment.

The proposed automaton is $C = (2, S, H, \delta)$ where:

- $S = \{0, 1, 2, 3, 4\}$,
- H is the Von Neumann's neighborhood,
- The transition table is given in appendix, chapter 5.

See figure 8.9.

6.4.2 Case of the isocetes triangle.

Definition of the triangle.

The figure which is given in 6.6 is in \mathcal{T}_i the class of the isocetes triangles.

A automaton which recognizes the isocetes triangles.

In order to recognize such figures, it's sufficient to initialize a wave (state 2) from the cells which are on the inclined borders of the figure (the cells the neighborhood of which has two cells in the state 1 and two cells in the state 0;

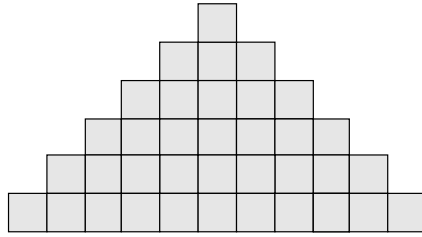

Figure 6.6: Isoceles triangle.

or , the cells which have an adjacent cell in the state 1 and the other ones in the state 0). This wave spreads to the interior of the figure. The figure belongs to \mathcal{T}_i if, at a given time, there exists a cell which is in state 1 and the neighborhood of which is compound of three cells in state 2 and one cell in state 0, and no cell in the rejection state.

The proposed automaton is $T_r = (2, S, H, \delta)$ such that:

- $S = \{0, 1, 2, 3, 4\}$,
- H is the Von Neumann's neighborhood,
- The transition table is given in appendix, chapter 5.

See figure 8.10.

6.5 8 – ellipses.

Up to now, we have only used the Von Neumann's neighborhood. But, likewise we can recognize 8 – ellipses (see figure 6.7. The principle of the automaton is clearly the same as previously (see figure 8.11 and 8.12).

We can also be interested in the case where the focuses are merged.

6.6 conclusion

In this chapter, we defined the discrete ellipse and we gave a method which allows to recognize it.

With the previous notations, the global time that is necessary to recognize an ellipse is $rtime(\mathcal{E}, A) = s$.

	9	9	9	9	9	9	9	9	
9	8	7	7	7	7	7	7	8	
8	7	6	5	5	5	5	6	8	
8	6	5	4	3	3	4	6	8	
8	6	4	3	2		4	6	8	
8	6	4		2	3	4	6	8	
8	6	4	3	3	4	5	6	8	
8	6	5	5	5	5	6	7	8	
8	7	7	7	7	7	7	8	9	
9	9	9	9	9	9	9	9		

Figure 6.7: "Moore ellipse" ($s=7$).

Chapter 7

Conclusions.

We have seen some simple families of figures which are easy to be recognized with two-dimensional cellular automata (the transition tables of which are given in appendix). These families of figures are divided into two classes. Either they are locally defined as the family of rectangles, the family of squares or globally defined as the L's family, the U's family, the O's family... but their recognition is local and an acceptance state or a rejection state spreads everywhere inside the figure. Or, they are defined with the help of waves, it's the case of the ellipses. For each family, we gave a cellular automaton which allows to recognize it. The main difficulty of this work concerns the fact that the automata have a lot of state transitions and then, they are not easy to handle (even if we have a suited software).

7.1 Extensions.

7.1.1 Other figures.

We would have looked at others figures; in particular, we would have been interested in the recognition of parallelograms. A parallelogram would be a figure defined as follows:

Definition 34

a- *Let q be any cell of the plane.*

Let $(b_i)_{i=1,\dots,n}$ be the sequence of cells defined as follows:

- $x_{b_1} = x_q$ and $y_{b_1} = y_q$
- $\forall i \geq 1, b_{i+1} \in H(b_i)$, if $H(b_i)$ is the set of the adjacent cells of b_i .
- $\forall i \geq 1, x_{b_{i+1}} > x_{b_i}$

$$- \forall i \geq 1, y_{b_{i+1}} \geq y_{b_i}, \text{ or } \forall i, y_{b_{i+1}} \leq y_{b_i}$$

Let $(c_j)_{j=0, \dots, m}$ be the sequence of cells defined as follows:

- $x_{c_1} = x_{b_1} - 1$ and $y_{c_1} = y_{b_1}$
- $\forall j \geq 1, c_{j+1} \in H(c_j)$, if $H(c_j)$ is the set of the adjacent cells of c_j .
- $\forall j \geq 1, y_{c_{j+1}} < y_{c_j}$
- $\forall j \geq 1, x_{c_{j+1}} \geq x_{c_j}$ or $\forall j \geq 1, x_{c_{j+1}} \leq x_{c_j}$

See figure 7.1.

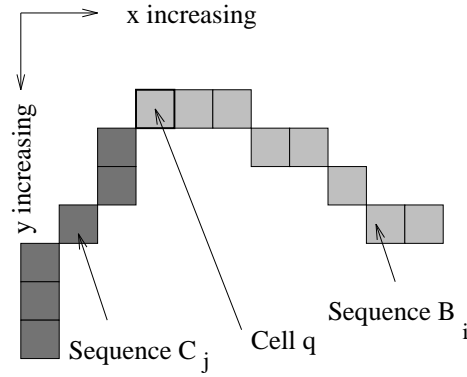

Figure 7.1: Basic elements which are necessary to build a parallelogram.

b- Let f_1 be the operation that consists in supplementing the sequence $(c_i)_{i=1, \dots, n}$. More precisely, the operation f_1 consists in adding the two following cells to the sequence $(c_i)_i$:

- c_0 such that $x_{c_0} = x_{c_1} - 1$ and $y_{c_0} = y_{c_1}$.
- c_{n+1} such that $x_{c_{n+1}} = x_{c_n} + 1$ and $y_{c_{n+1}} = y_{c_n}$.

Let f_2 be the operation that consists in supplementing the sequence $(b_j)_{j=1, \dots, m}$. Likewise, f_2 consists in adding the two following cells to the sequence $(b_j)_j$:

- b_0 such that $x_{b_0} = x_{b_1}$ and $y_{b_0} = y_{b_1} + 1$
- b_{m+1} such that $x_{b_{m+1}} = x_{b_m}$ and $y_{b_{m+1}} = y_{b_m} - 1$

See figure 7.2

c- Let F_1 be the " $(c_i)_i$ translation" function such that: any cell c of the plane is in correspondence with the cell c' such that:

$$x_{c_0} = x_c, y_{c_0} = y_c \text{ and } x_{c'} = x_{c_{n+1}} \text{ and } y_{c'} = y_{c_{n+1}}.$$

Let F_2 be the " $(b_j)_j$ translation" function such that: any cell c of the plane

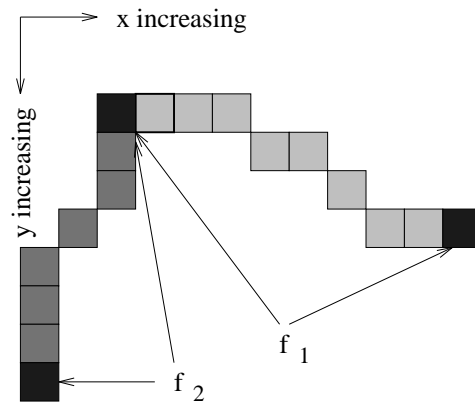

Figure 7.2: f_1 and f_2 , operations that consist in supplementing sequences.

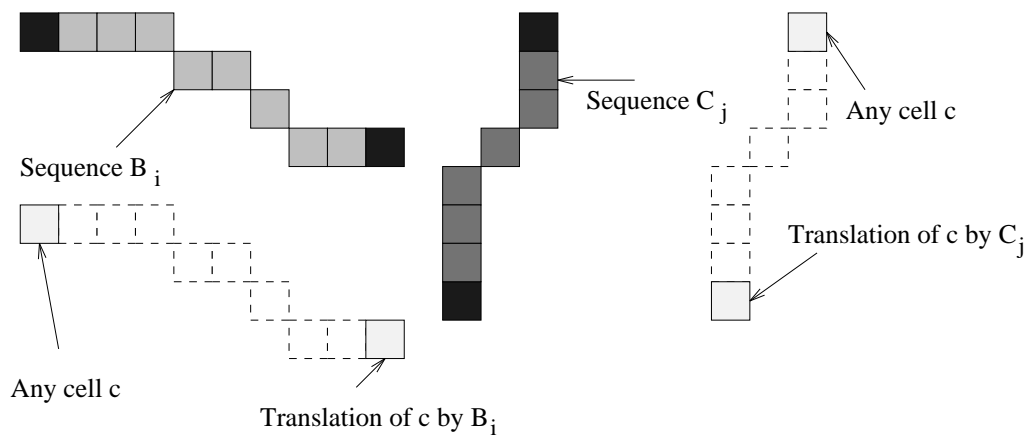

Figure 7.3: Translation of a sequence.

is in correspondence with the cell c' such that:

$x_{b_0} = x_c, y_{b_0} = y_c$ and $x_{c'} = x_{b_{m+1}}, y_{c'} = y_{b_{m+1}}$. See figure 7.3

d- We call *parallelogram*, any 8-connected figure F , without hole and which is built from a given cell q and two sequences $(c_i)_{i=1,\dots,n}$ and $(b_j)_{j=1,\dots,m}$ as follows:

- Any cell c_i ($i = 1, \dots, n$) is in correspondence with the cell $c'_i = F_1(c_i)$. We obtain the sequence $(c'_i)_{i=1,\dots,n}$.
- Any cell b_j ($j = 1, \dots, m$) is in correspondence with the cell $b'_j = F_2(b_j)$. We obtain the sequence $(b'_j)_{j=1,\dots,m}$.
- The sequences $(c_i)_i, (b_j)_j, (c'_i)_i$ and $(b'_j)_j$ are the four sides of the parallelogram.

See figure 7.4

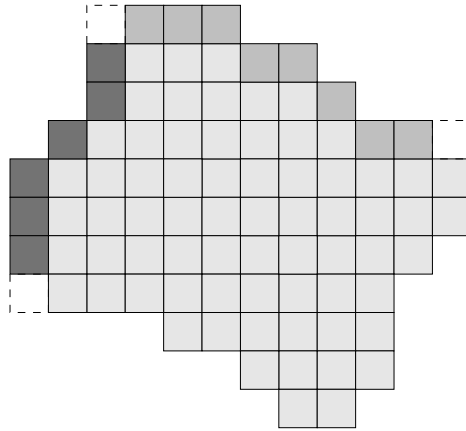

Figure 7.4: Example of parallelogram.

As a parallelogram is a 8-connected figure, we have to consider Moore's neighborhood in order to recognize it. Remember that all the cells that are in the figure are in state 1 and the others are in state 0.

The idea consists in comparing the sides two and two.

For this, a first step consists in "making going down" the "uppermost" border on the "rock-bottom" border, the uppermost and most left cell (known) helps as a guide. So, all the cells that belong to the uppermost border make in turns the same shifting as the guide cell. Otherwise, the uppermost and most right cell verifies, when it goes down, if the right border is well shaped. At last, if at a given time, all the cells of the figure are either in the state 1 or in the acceptance state then the figure is a parallelogram.

We can notice that now, it's a "veil" which undulate rather than a wave which spreads (the buckle is formed by the cells that go down). This idea needs to be developed.

7.1.2 Properties.

We would also have looked for automata that indicate if a given figure has a given property. For example, it can be interesting looking for an automaton that allows to decide if a figure has a hole or not. In this case, the idea can be the following one (see figure 7.5):

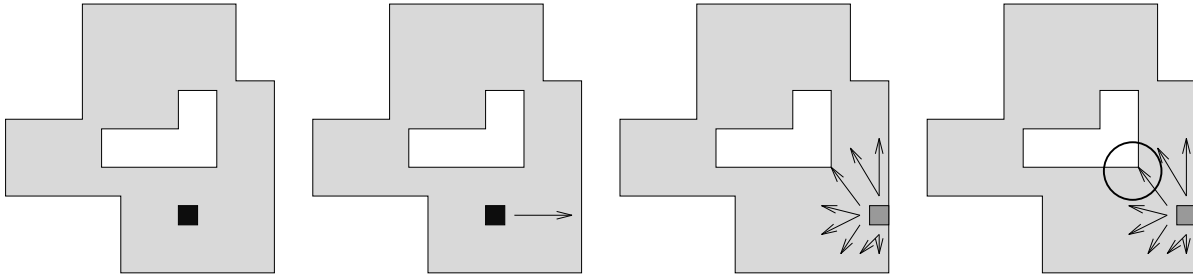

Figure 7.5: How to know if a figure has a hole?

- We assume that a cell of the figure has been elected. The problem of the election is a problem that has already been studied. In any cases, we can't elect on any graph. In the case where the cells of the plane know their orientation, this is possible.
- In the first step, this cell spreads to the right, for example, as far as touching a border (the border of the figure or the border of a hole).
- Afterwards, the cell of the border that corresponds, denoted by c , is going to emit a wave which spreads in all the directions in the figure.
- We look at the wave front. A part of this front marks the border in which c is. If the front of the wave which propagates in the figure reach a border, it is not the border in which c is. So, the figure has a hole.

This problem needs to be deepened.

7.1.3 Implementation.

We'd also be interested in implementing complex cellular plane automata on parallel machines. Then, the problem would be to know how to define the automaton. So, it would be necessary to know if it's useful to give all the state

transitions. We can notice that any automaton corresponds to logic formulas. For example, to say that a wave spreads (case of ellipses) this is to say that one state is "stronger" than any others but also, "strongest" than others. And this doesn't need a big table!

7.2 Link with the Firing Squad problem.

We could do the link between the recognition of patterns with plane cellular automata and the Firing Squad problem. Let us recall what is this problem.

7.2.1 The Firing Squad problem.

The One-dimensional case.

The *Firing Squad problem*, or *fssp*, given by Myhill in 1957 (Moore, 1964) can be described as follows. We consider a string of cells such that each cell contains a copy of the same finite automaton A (see figure 7.6). The string is finite but

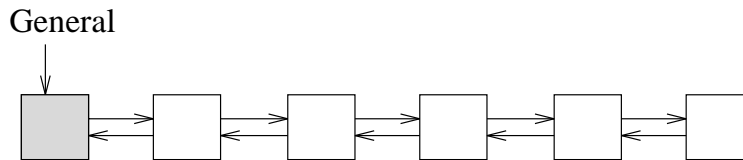

Figure 7.6: A string of cells.

arbitrarily long. The inner state of a cell at $t + 1$ depends on its inner state at t and on the inner states of its two adjacent cells (to the right and to the left) at t . At $t = 0$, one of the cells that is at the end of the string (called "the general") enters a state s_r ("fire when ready"), whereas the others cells (called "the soldiers") enter a quiescent state s_q . Then, the string must evolve so that at any time $t = t_f$, all the cells ("the general" and "the soldiers") must execute a state transition in order to enter in the state s_f ("fire"), and no cell enters s_f before t_f . The problem consists in defining some automaton A , taking into account that it mustn't depends on the number of cells in the string.

The Two-dimensional case.

In the two-dimensional case, we speak about *synchronization of patterns*. Nguyen and Hamacher in [NH74] have defined such a problem. Then, a pattern F is a set of points which belong to \mathbb{Z}^2 . If x and y belong to F then there exists a string of cells that are directly connected which allows to go from x to y ; the neighborhood determines the different possible paths (see figure 7.7). Let J_i be the set of cells compound of the cell $x = (i, j)$ and its adjacent cells. Then,

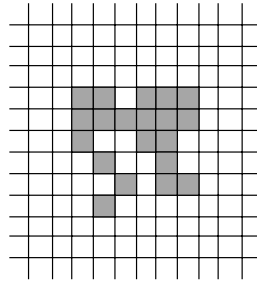

Figure 7.7: A possible pattern.

the problem of the synchronization of patterns can be word as follows:

We consider any pattern F and any cell G of F . At the initial time t_0 , we have:

- Exactly one cell of F in the special state s_r ,
- The other ones are in one of the following states: s_{q_1} or s_{q_2} , s_{q_0} is the quiescent state.

We consider the uniform local state update function defined by: if x and $H(x)$ belong to $\{s_{q_0}, s_{q_1}\}$ at t_i then x doesn't change its state at time t_{i+1} . s_{q_0} and s_{q_1} can be both considered as quiescent states because it is necessary to have an other state in the neighborhood in order to change them. At time $t_0 + T = t_f$ all the cells enter the state s_f , the "fire" state, simultaneously and for the first time and all the others cells of the plane have come back to the state s_{q_0} . Nguyen and Hamacher describe a method of construction where $T = 8n + 10$ and n is the distance between the cell the state of which is s_r and the smaller square centered on s_r which contains F .

We can notice that Nguyen and Hamacher authorize the use of cells that are external of the pattern in order to synchronize. The solution which is proposed by Szwerinski, developed in the next part, only uses cells that belong to the pattern.

7.2.2 Solutions that are proposed by Szwerinski.

H. Szwerinski in [Szw82] proposes an optimal solution to the fssp for rectangles the size of which is n with the general in an arbitrary position.

Dimension 1.

First, H. Szwerinski recall an optimal solution to the fssp in dimension 1, which is explained by V.I. Varshavski, V.B. Marakhovsky and V.A. Peschansky in [VVP69]. The principle is the following one: the algorithm consists in breaking up into successive segment the string of automata (see figure 7.8).

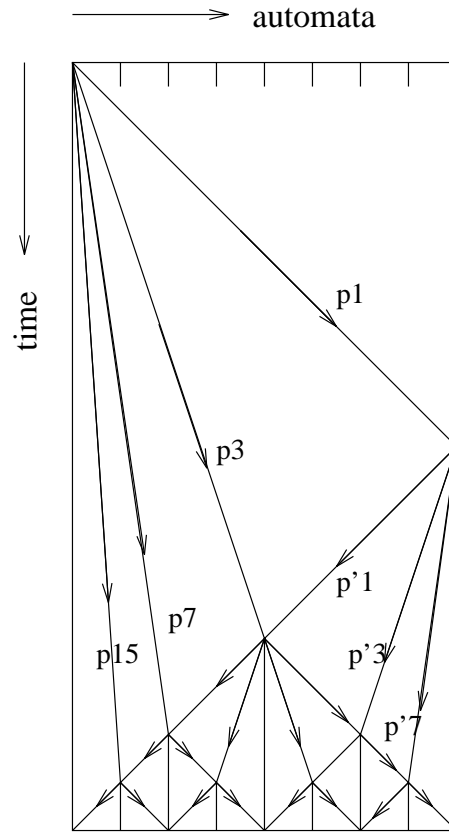

Figure 7.8: Breaking up of the string.

The partition of the string is done like that: In the case where the general is at one end of the row, the signal of initialization put the automaton which is at the end in a preterminal state and two signals p_1 and p_3 start spreading on the string since this automaton. The first signal has a propagation speed which equals one unit and the second one has a propagation speed which equals $\frac{1}{3}$ (a signal spreads with a speed $\frac{1}{n}$ if it goes to the adjacent automaton after being stayed n time units in the previous one). When the signal p_1 reaches the end of the row, it makes the automaton which is at the end enters the preterminal state and comes back with the same speed. The meeting of the reflected signal with the signal p_3 takes place exactly in the middle of the row, and the corresponding automaton (or the two corresponding automata if the number of automata in the row is even) enters the preterminal state. If the reflected signal goes on spreading with the same speed, and if at the initial time, the first automaton emits a signal the speed of which is $\frac{1}{7}$ (signal p_7) then these signals will meet $\frac{1}{4}$ away from the beginning of the row. So, if all the automata which are in the preterminal state emit a sequence of signals which spread with speeds $\frac{1}{2^{m+1}-1}$ and if the automata that are meeting points enters the preterminal state, then the processus of recursive cutting off will takes place as in the figure 7.8. The family of signals $\frac{1}{2^{m+1}-1}$ is built by recurrence. The signal $\frac{1}{2^{m+1}-1}$ uses the signal $\frac{1}{2^m+1}$.

In the case where the initialization signal is done by any automaton of the row, the general image of the propagation is shown in the figure 7.9. After that the initialization signal has been sent, two signals p_1 and p'_1 start spreading in the two directions, since the initial automaton. The two signals have a speed which equals 1. The initial automaton doesn't enter the preterminal state if it is not at the end of the row. When the signals p_1 and p'_1 reach the ends of the row, they make the automaton which is at the end enter the preterminal state and they reflect; so there are signals which spread with the same speed. As in the previous case, an automaton which enters the preterminal state generates a sequence of signals the speed of which is $\frac{1}{2^{m+1}-1}$. If the initialization signal has been generated by the automaton O which is at the end of the row called initial automaton, the image of the propagation of the signals is the same as the one of the figure 7.8 with $O' = O$. The signal p'_3 which starts from O' with a speed $\frac{1}{3}$ meets the reflected signal p'''_3 at A_1 (the middle of the row). It is not difficult to see that the signal p'_3 meet the signal p''_1 at A which corresponds to the position of the initial automaton. Then, in order to do a initial cutting of the row, it is necessary to change the speed of the signal p''_1 : it updates from 1 to $\frac{1}{3}$ at the point A . In order to do correctly the rest of the cutting, it is necessary that the speed of any signal which start from O_1 with the speed $\frac{1}{2^m-1}$ becomes $\frac{1}{2^{m+1}-1}$.

Dimension 2.

The algorithm that is proposed by Szwerinski can be decomposed into two phases (which can overlap if necessary). The first one identifies the cells which

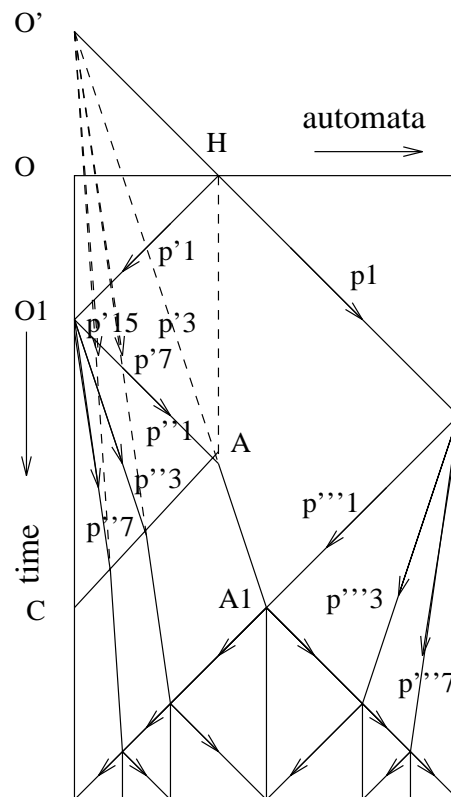

Figure 7.9: Morcellement de la chaîne (cas général).

are on the middle row(s), the middle column(s), the border cell, likewise the row(s) or the column(s) that are $\frac{1}{2}, \frac{3}{4}, \frac{7}{8}, \dots$ away from the middle row(s) or the middle column(s). This detection is done using a one-dimensional algorithm of fssp in each row and in each column.

The second phase starts from the cells which are in the middle of rows and columns. It's an algorithm of fssp which uses the information given by the first step. The necessary time to do this phase is the necessary time for a signal to go the border of the figure from the middle of it.

7.2.3 Questions.

We would be interested in the following questions:

- Does the H. Szwerinski's solution only allow to synchronize rectangles? Or others patterns?
- Is any recognizable pattern with plane cellular automata synchronisable, and conversely?
- Comparison between the time of synchronization and the time of local or global recognition.

Chapter 8

Addendum

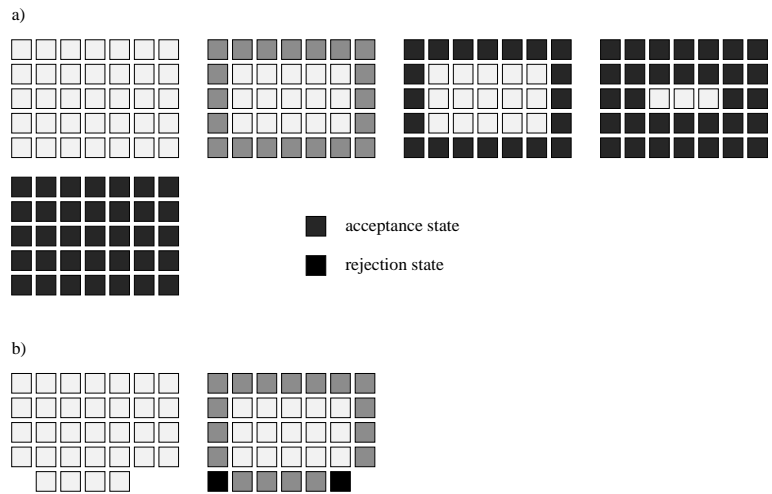

Figure 8.1: Recognition of rectangles.

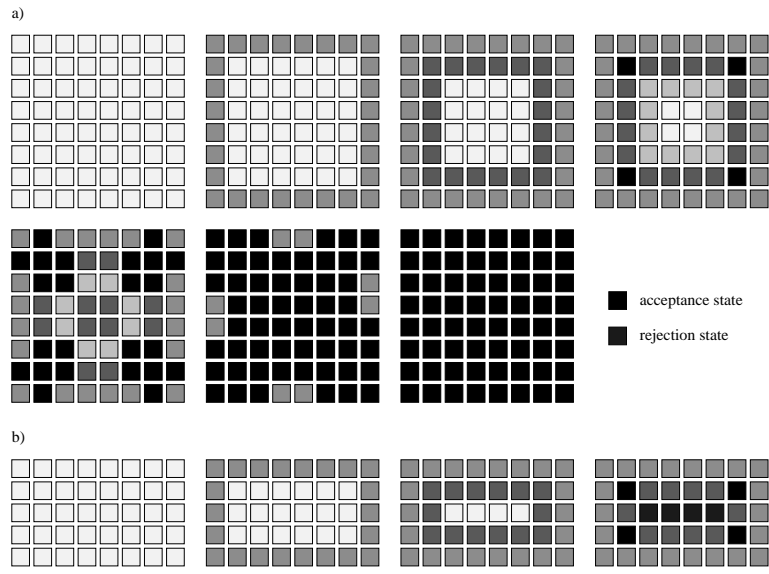

Figure 8.2: Recognition of squares.

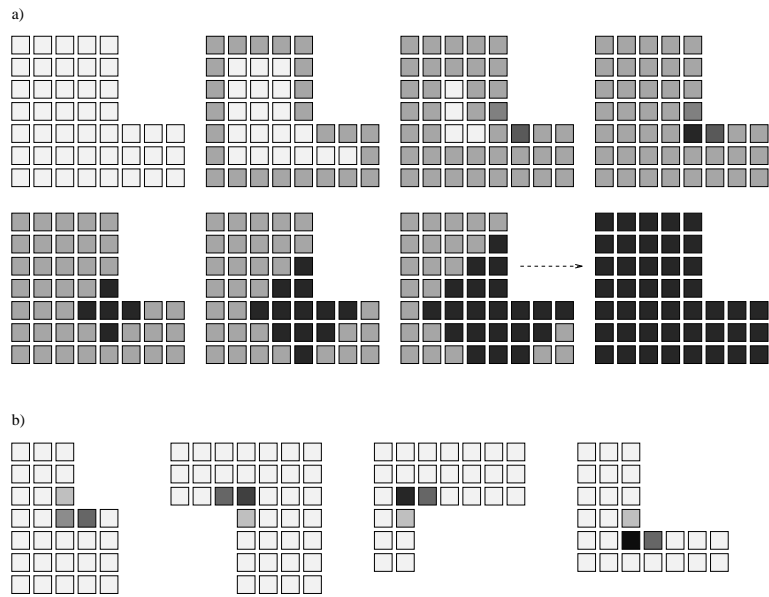

Figure 8.3: Recognition of L.

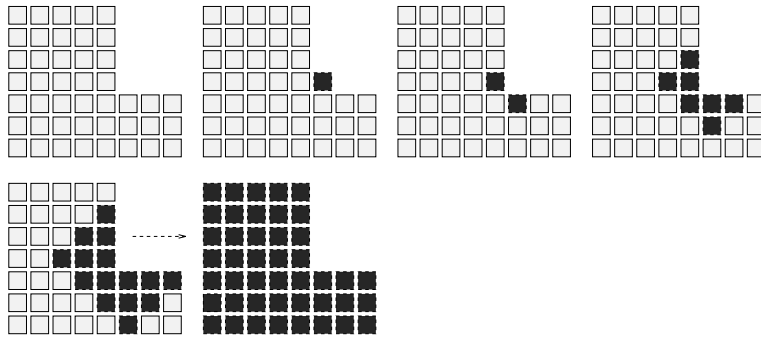

Figure 8.4: Recognition of L, using cells which don't belong to the figure.

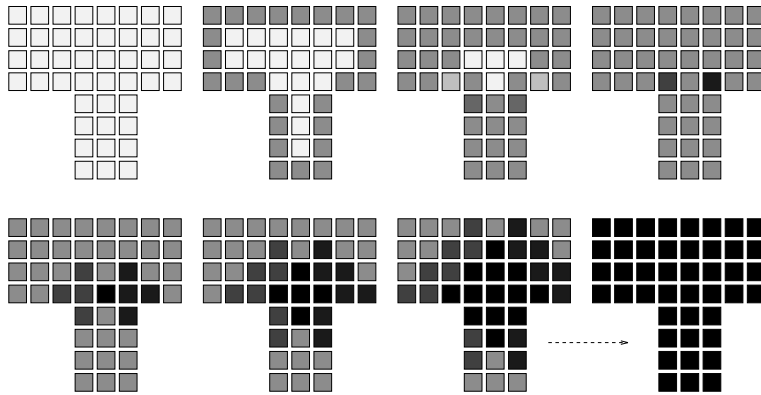

Figure 8.5: Recognition of T.

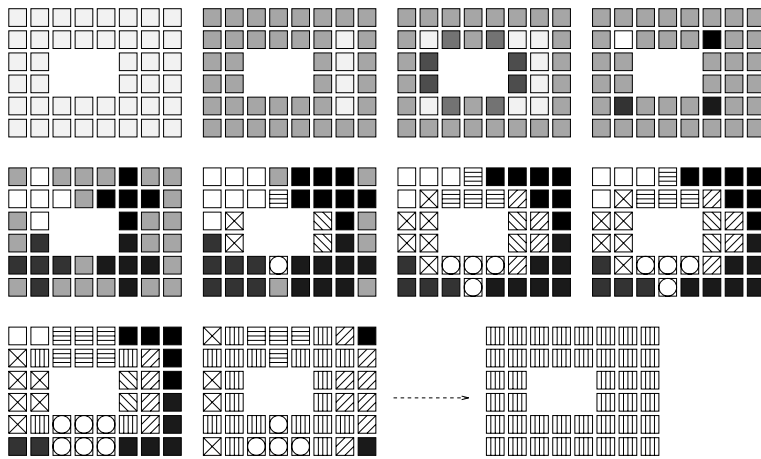

Figure 8.6: Recognition of O.

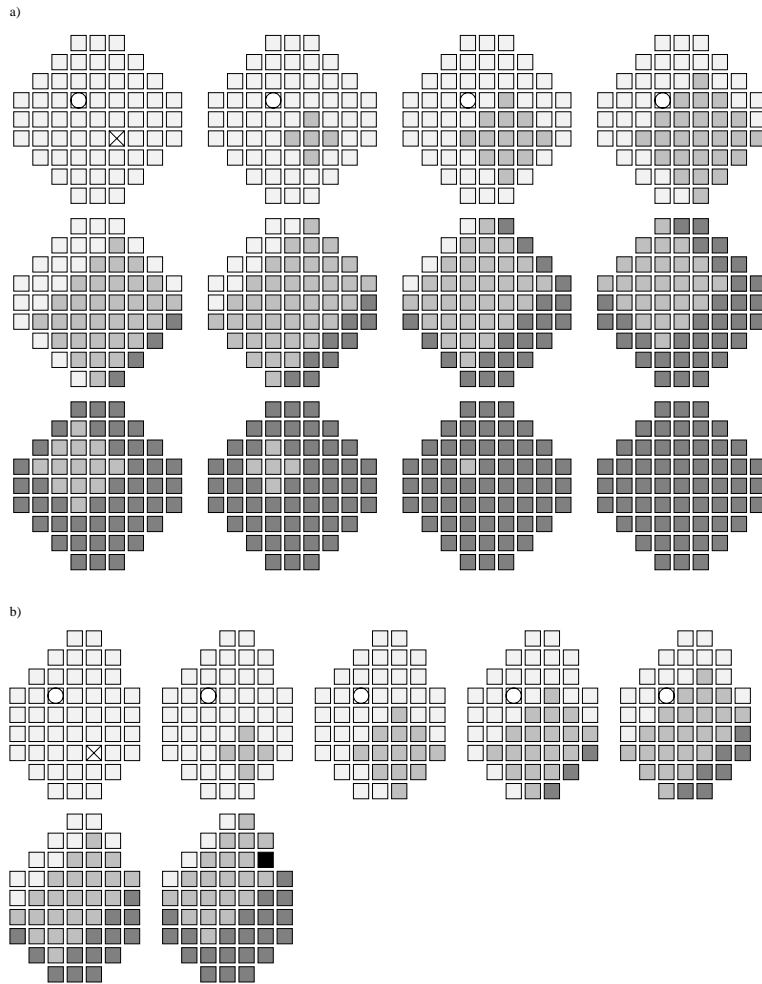

Figure 8.7: Recognition of 4-ellipses.

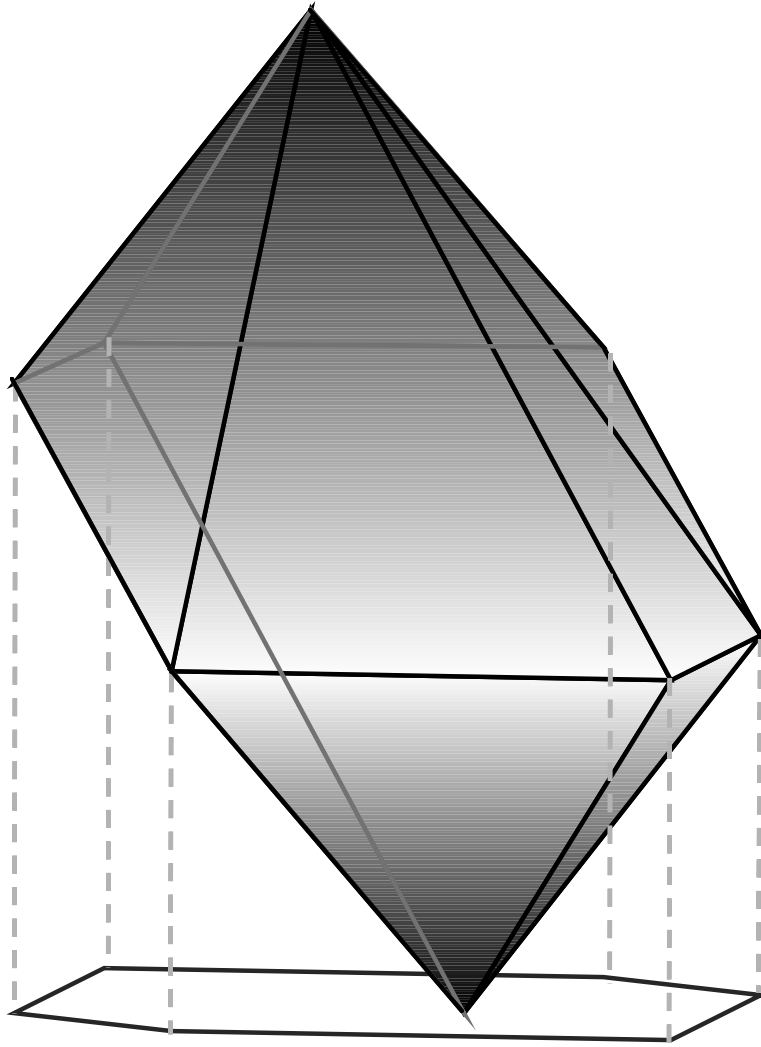

Figure 8.8: Space-time diagram of the automaton that recognizes 4-ellipses.

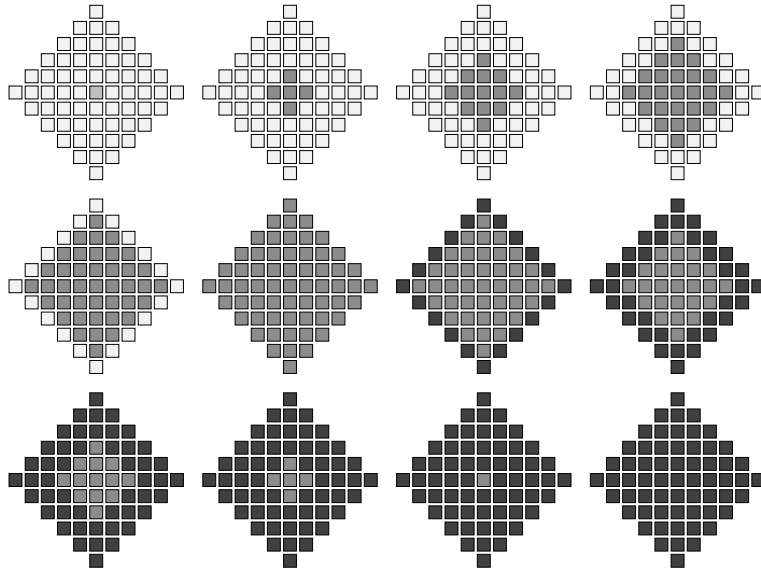

Figure 8.9: Recognition of 4-ellipse the focuses of which are merged.

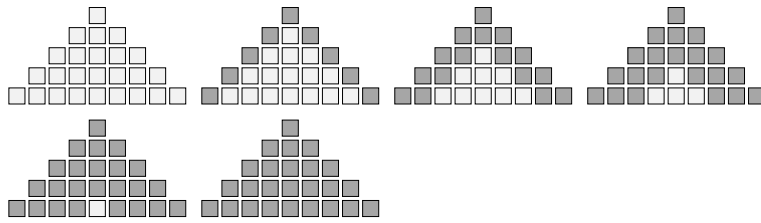

Figure 8.10: Recognition of triangles.

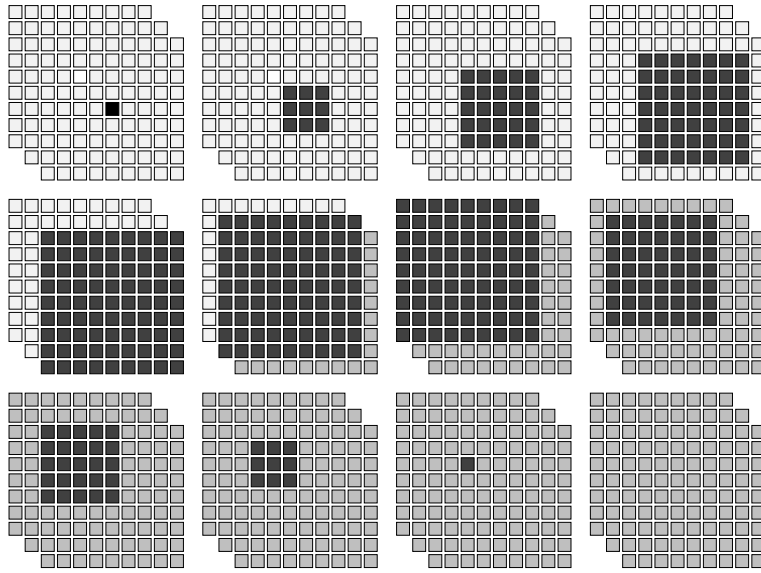

Figure 8.11: Recognition of 8-ellipses.

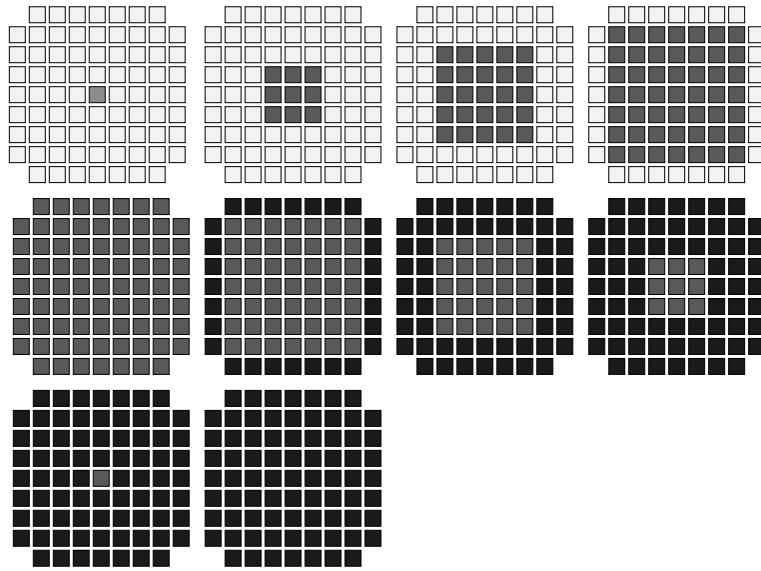

Figure 8.12: Recognition of 8-ellipses the foci of which are merged.

Bibliography

- [AM91] Jean-Marc Chassery Annick Montanvert. *Géométrie discrète en analyse d'images*. HERMES, 1991.
- [A.R74] A. Rosenfeld. Digital straight line segments. *IEEE Trans. on Computer*, pages 1264–1269, 1974.
- [Gra75] A. Grasselli. Synchronisation of cellular arrays: The firing squad problem in two dimensions. *Information and Control*, (28):113–124, 1975.
- [Gre83] J.J. Grefenstette. Network structure and firing squad synchronisation problem. *Journal of Computer and System Science*, 26:139–152, 1983.
- [Kob78] K. Kobayashi. The firing squad synchronisation problem for two dimensional arrays. *Theoretical Computer Science*, 7:149–167, 1978.
- [Maz93] J. Mazoyer. Cellular automata: a computational device, 1993. RR LIP, ENS Lyon.
- [NH74] H.b Nguyen and V.C. Hamacher. Pattern synchronisation in two-dimensional cellular spaces. In *Information and control*, volume 26, pages 12–23. 1974.
- [R94] Z. Róka. Automates cellulaires sur graphes de cayley. Master's thesis, Ecole Normale Supérieure de Lyon, 1994.
- [Rom76] F. Romani. Cellular automata synchronisation. *Information Science*, 10:299–318, 1976.
- [Ros70] A. Rosenfeld. Connectivity in digital pictures. *Journal of ACM*, 17(1):146–160, 1970.
- [Ros73] A. Rosenfeld. Arcs and curves in digital pictures. *Journal of ACM*, 20(1):81–87, 1973.
- [Ros74] A. Rosenfeld. Adjacency in digital pictures. *Information and Control*, 26:24–33, 1974.

- [Ros75] A. Rosenfeld. A converse to the jordan curve theorem for digital curves. *Information and Control*, 29:292-293, 1975.
- [Ros79] A. Rosenfeld. Digital topology. *American Math. Monthly*, pages 621-630, 1979.
- [ROS89] A. ROSENFELD. Digital topology. *The Mathematical Intelligencer*, 11(3):69-72, 1989.
- [Szw82] TH. Szwerinski. Time-optimal solution of firing-squad-synchronisation-problem for n-dimensional rectangles with the general at an arbitrary position. *Theoretical Computer Science*, 19:305-320, 1982.
- [vN67] J. von Neumann. Theory of self reproducing automata. *A. W. Burks ed. University of Illinois Press, Urbana, Illinois*, 1967.
- [VVP69] V.B. Marakhovsky V.I. Varshavski and V.A. Peschanski. Synchronisation of interacting automata. *Mathematical Systems Theory*, 14:212-230, 1969.

List of Tables

3.1	The transition function of the automaton recognizing the rectangle's family.	28
4.1	Transition table of the automaton which recognizes the squares (2).	36
4.2	Transition table of the automaton which recognizes the squares (2).	37

List of Figures

1.1	Propagation of a one-dimensional wave.	3
1.2	Space-time diagram of a 2D wave which spreads at quickest speed.	4
2.1	Von Neumann's neighborhood.	6
2.2	Moore's neighborhood.	7
2.3	4-connected and 8-connected paths, 4-connected and 8-connected figures.	8
2.4	The external layer, $L_{ext}(F)$, of the figure F	8
2.5	Vertices of a figure.	9
3.1	Description of the border of F	12
3.2	In a first time, the border of F is constituted by four parts	12
3.3	The constructed sequence is either a spiral or a rectangle	13
3.4	i and j axis.	13
3.5	Jordan's lemma for \mathbb{Z}^2	13
3.6	The adjacent cells of the upper-left most cell	15
3.7	The higher border	15
3.8	The righter border	16
3.9	The bottom border	18
3.10	The left most border	19
3.11	The left most border	20
3.12	Construction of the path by induction	21
3.13	Construction of the spiral	21
3.14	Case $m \equiv 0 \pmod{4}$	23
3.15	Relations between the points h_{k_m}	23
3.16	Case $j_{k_6} \geq j_{k_2}$	24
3.17	General case of the lemma 7	25
3.18	Case $i_{k_{4l+3}} > i_{k_{4l+2}}$	26
3.19	Different ends of the spiral construction	26
3.20	The border of F	27
3.21	Examples of rectangles recognition.	30
4.1	The layers of a figure.	32

4.2	Neighborhoods that verify the property S .	32
4.3	Adding a layer.	34
5.1	Coming out vertices of a figure.	40
5.2	Retracting vertices of a figure.	40
5.3	Examples of "L".	40
5.4	Definition of the "L".	41
5.5	How differentiate the retracting vertexes.	42
5.6	Utilization of cells that are outside the figure.	43
5.7	Examples of "U".	44
5.8	Examples of figures that don't belong to U .	44
5.9	Marking the retracting angles.	45
5.10	Meeting of two states.	45
5.11	Examples of "O".	46
5.12	Recognition of "O".	47
5.13	Subtraction of two rectangles.	48
5.14	Recognition of "T".	48
5.15	Encoding of a figure.	50
5.16	Division of the figure.	51
6.1	Sum of distances (focus aligned or not).	53
6.2	Example of ellipse ($s=12, d = d_4$).	53
6.3	Definition of the plane 4 - <i>wave</i> .	55
6.4	Repartition of the different wavetime.	57
6.5	Ellipse the focuses of which are merged.	58
6.6	Isocetes triangle.	59
6.7	"Moore ellipse" ($s=7$).	60
7.1	Basic elements which are necessary to build a parallelogram.	62
7.2	f_1 and f_2 , operations that consist in supplementing sequences.	63
7.3	Translation of a sequence.	63
7.4	Example of parallelogram.	64
7.5	How to know if a figure has a hole?	65
7.6	A string of cells.	66
7.7	A possible pattern.	67
7.8	Breaking up of the string.	68
7.9	Morcellement de la chaîne (cas général).	70
8.1	Recognition of rectangles.	72
8.2	Recognition of squares.	73
8.3	Recognition of L.	73
8.4	Recognition of L, using cells which don't belong to the figure.	74
8.5	Recognition of T.	74
8.6	Recognition of O.	74

8.7	Recognition of 4-ellipses.	75
8.8	Space-time diagram of the automaton that recognizes 4-ellipses. .	76
8.9	Recognition of 4-ellipse the focuses of which are merged.	77
8.10	Recognition of triangles.	77
8.11	Recognition of 8-ellipses.	78
8.12	Recognition of 8-ellipses the focuses of which are merged.	78