



HAL
open science

Rhombus tilings:decomposition and space structure.

Frédéric Chavanon, Eric Remila

► **To cite this version:**

Frédéric Chavanon, Eric Remila. Rhombus tilings:decomposition and space structure.. [Research Report] LIP RR-2004-30, Laboratoire de l'informatique du parallélisme. 2004, 2+21p. hal-02101894

HAL Id: hal-02101894

<https://hal-lara.archives-ouvertes.fr/hal-02101894>

Submitted on 17 Apr 2019

HAL is a multi-disciplinary open access archive for the deposit and dissemination of scientific research documents, whether they are published or not. The documents may come from teaching and research institutions in France or abroad, or from public or private research centers.

L'archive ouverte pluridisciplinaire **HAL**, est destinée au dépôt et à la diffusion de documents scientifiques de niveau recherche, publiés ou non, émanant des établissements d'enseignement et de recherche français ou étrangers, des laboratoires publics ou privés.



Laboratoire de l'Informatique du Parallélisme

École Normale Supérieure de Lyon
Unité Mixte de Recherche CNRS-INRIA-ENS LYON n° 5668

***Rhombus tilings:
decomposition and space structure***

Frédéric Chavanon
Éric Rémila

June 2004

Research Report N° 2004-30

École Normale Supérieure de Lyon, 46 Allée d'Italie, 69364 Lyon Cedex 07, France
Téléphone : +33(0)4.72.72.80.37 Fax : +33(0)4.72.72.80.80 Adresse électronique : lip@ens-lyon.fr

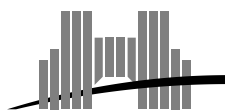

Rhombus tilings: decomposition and space structure

Frédéric Chavanon
Éric Rémila

June 2004

Abstract

We study the spaces of rhombus tilings, i.e. the graphs whose vertices are tilings of a fixed zonotope, and two tilings are linked if one can pass from one to the other one by a local transformation, called flip.

We first use a decomposition method to encode rhombus tilings and give a useful characterization for a sequence of bits to encode a tiling.

In codimension 2, we use the previous coding to get a canonical representation of tilings, and an order structure on the space of tilings, which is shown to be a graded poset, from which connectivity is deduced.

Keywords: tilings, structure, order

Résumé

Nous étudions les espaces de pavages rhombiques, i.e. les graphes dont les sommets sont les pavages d'un zonotope fixé, et deux pavages sont liés si on peut passer de l'un à l'autre par une série de transformations locales appelées flips.

Nous utilisons une méthode de décomposition pour coder ces pavages, et donnons une caractérisation des séquences de bits codant effectivement des pavages.

En codimension 2, nous utilisons ce codage pour donner une représentation canonique des pavages, et une structure d'ordre sur l'espace des pavages. Cet ordre est gradué, ce qui nous permet d'en déduire la connexité de l'ensemble.

Mots-clés: pavage, structure, ordre

Rhombus tilings: decomposition and space structure

Frédéric Chavanon *

Éric Rémila †

Abstract

We study the spaces of rhombus tilings, i.e. the graphs whose vertices are tilings of a fixed zonotope, and two tilings are linked if one can pass from one to the other one by a local transformation, called flip.

We first use a decomposition method to encode rhombus tilings and give a useful characterization for a sequence of bits to encode a tiling.

In codimension 2, we use the previous coding to get a canonical representation of tilings, and an order structure on the space of tilings, which is shown to be a graded poset, from which connectivity is deduced.

1 Introduction

Rhombus tilings are tilings of zonotopes with rhombohedra. More precisely, we fix a sequence (v_1, v_2, \dots, v_D) of vectors of \mathbb{R}^d (such that each subsequence $(v_{i_1}, v_{i_2}, \dots, v_{i_d})$ of length d is a basis of \mathbb{R}^d) and a sequence (m_1, m_2, \dots, m_D) of positive integers. The tiled zonotope V is the set: $V = \left\{ v \in \mathbb{R}^d, v = \sum_{i=1}^D \lambda_i v_i, 0 \leq \lambda_i \leq m_i, m_i \in M, v_i \in V \right\}$, and each tile is (a translated copy of) a rhombohedron defined by a set $\{v_{i_1}, v_{i_2}, \dots, v_{i_d}\}$ of d vectors. The notion of flip on tilings is carefully studied. Assume that a tiling T of Z contains $d + 1$ tiles which pairwise share a facet. In such a case, a new tiling T_{flip} of Z can be obtained by a flip consisting in changing the position of the $d + 1$ previous tiles. The space of tilings of Z is the graph whose vertices are tilings of Z and two tilings are linked by an edge if they differ by a single flip. The structure of spaces of tilings is very interesting, since rhombus tilings appear in physics as a classical model for quasicrystals [1].

In the first part of this paper, we use ideas (deletion, contraction) issued from matroid theory [2, 8] to get a decomposition method for tilings (section 3). We see how to encode a tiling by a sequence of small tilings, containing $d + 1$ tiles. Informally, this encoding can be seen as a pilling of (hyper)cubes, in a similar way as it has been done by Thurston [13] for the particular case of tilings with lozenges ($d = 2$ and $D = 3$) for any simply connected polygon. The first important result of the paper (the reconstruction theorem, section 4) is a

*Laboratoire de l'Informatique du Parallélisme, umr 5668 CNRS-INRIA-UCB Lyon 1-ENS Lyon, 46 allée d'Italie, 69364 Lyon cedex 07, France. Frederic.Chavanon@ens-lyon.fr

†Laboratoire de l'Informatique du Parallélisme, umr 5668 CNRS-INRIA-UCB Lyon 1-ENS Lyon, 46 allée d'Italie, 69364 Lyon cedex 07, France and GRIMA, IUT Roanne, 20 avenue de Paris, 42334 Roanne cedex, France. Eric.Remila@ens-lyon.fr

characterization of sequences of small tilings which really encode a (big) tiling. This characterization is local in the sense that it can be checked using a set of conditions, each of them using a bounded number of small tilings.

The complexity of the space of tilings is strongly related to the parameter $c = D - d$, called the codimension. If $c = 0$, there exists a unique tiling. For $c = 1$, it can easily be shown (using the pilling of cube interpretation) that the space of tilings can be directed so as to get a structure of distributive lattice. In Section 5, using the reconstruction theorem, we introduce a representation of tilings which allows to prove the main result of the paper: for $c = 2$, the space of tilings can be directed so as to get a graded poset (with single maximal and minimal elements). This result clearly induces the connectivity of the space, which is a non-trivial result linked to the *general Baues problem* [11] on polytopes. As another consequence, we obtain that flips induce a Markov chain on the space of tilings, whose limit distribution is uniform.

Before this paper, a parallel study has been done by Ziegler [15], about *higher Bruhat orders*. Those are combinatorial structures, which can be interpreted as extensions of matroids. We recall that the Bohne-Dress theorem [12] claims that tilings of zonotopes can also be interpreted as extensions of matroids. Thus, the study from Ziegler can be seen as the study of tilings of *unitary* zonotopes constructed from vectors in cyclic arrangement. For those zonotopes, Ziegler proves that the space of tilings can be directed so as to get a graded poset (with a unique minimal element and a unique maximal element), for $c \leq 4$. Later, Felsner and Weil [7] prove the same result, when $d \leq 2$. To our knowledge, the connectivity problem is still open for the other kinds of zonotopes. We mention that R. Kenyon [10] has proved the connectivity in dimension 2, for any simply connected domain.

2 Tilings of Zonotopes and Minors

We deal in this paper with a particular case of tilings in \mathbb{R}^d , called *zonotopal rhombic tilings*. Let us now define the fundamental elements studied in the following.

The canonical basis of \mathbb{R}^d will be noticed (e_1, e_2, \dots, e_d) . Let $V = (v_1, \dots, v_D)$ be a sequence of D vectors in \mathbb{R}^d such that $D \geq d$ and each subsequence $(v_{i_1}, v_{i_2}, \dots, v_{i_d})$ is a basis of \mathbb{R}^d . The parameter $c = D - d$ is called the *codimension*.

Let $M = (m_1, \dots, m_D)$ be a sequence of D nonnegative integers. m_i is associated with the vector v_i and called the *multiplicity* of v_i . The *zonotope* $Z = (V, M)$ associated with V and M is the region of \mathbb{R}^d defined by: $\left\{ v \in \mathbb{R}^d, v = \sum_{i=1}^D \lambda_i v_i, 0 \leq \lambda_i \leq m_i, m_i \in M, v_i \in V \right\}$. Thus, Z is the convex hull of the finite set $\left\{ v \in \mathbb{R}^d, v = \sum_{i=1}^D \lambda_i m_i v_i, \lambda_i \in \{0, 1\}, v_i \in V \right\}$.

One can define classically (see for example [14] p. 51-52) its faces, vertices (faces of dimension 0), edges (faces of dimension 1), and facets (faces of dimension $d - 1$). The number: $s = \sum_{i=1}^D m_i$ is the *size* of the zonotope Z ; we say that Z is an *s-zonotope*. Z is said to be *unitary* if all the multiplicities are equal to 1 (see Figure 1 for examples).

Let $Z = (V, M)$ be a zonotope. The sequence of vectors forming the sequence V is called the *type* of Z . A *prototile* is a unitary zonotope constructed with a subsequence V' of d distinct vectors taken in V . A sequence V of D vectors of \mathbb{R}^d induces $\binom{D}{d}$ different prototiles. A *tile* t is a translated prototile, i.e. it is defined by a pair (p, w) , where p is a prototile and w a translation vector (formally, we have: $t = w + p$). Since tiles are some particular polytopes, their vertices, edges and facets are defined as well. The type of a tile is the type of the

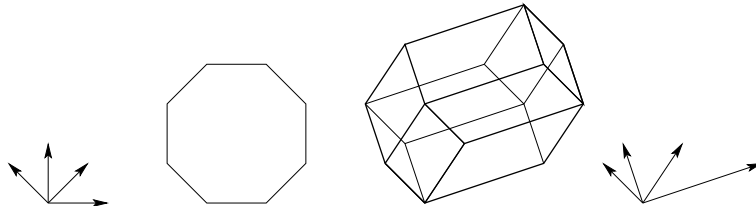

Figure 1: A 2-dimensional zonotope and a 3-dimensional zonotope both defined on 4 vectors

corresponding prototile.

A *tiling* T of a zonotope $Z = (V, M)$ is a set of tiles constructed with vectors in V , such that each intersection between tiles is a face of the tiles (i.e. there is no overlap) and the union of tiles is equal to Z (i.e. there is no gap). The extremal points of a tile are the *vertices* of the tiling, and the edges of a tile are the *edges* of the tiling. Two tiles are *adjacent* if they share a whole facet. We say that Z is the *support* of the tiling T . If Z is an s -zonotope, we say that T is an s -tiling.

2.1 De Bruijn sections

Definition 1 (lifting, height function) Let $Z = (V, M)$ be a zonotope, with $V = (v_1, \dots, v_D)$, and x_0 be a fixed extremal point of Z .

A *lifting* of V is a sequence $U = (u_1, \dots, u_D)$ of vectors of \mathbb{R}^{d+1} , for each integer j such that $1 \leq j \leq D$, we have: $u_j = (v_j, \alpha_j)$.

Let T be a tiling of Z . The associated *lifting* is the unique function $f_{T,U}$ which associates to each vertex of T_Z a vector in \mathbb{R}^{d+1} and satisfies the following properties: $f_{T,U}(x_0) = (0, 0, \dots, 0)$ and for any pair (x, x') of vertices of T such that $x' = x + v_i$ and $[x, x']$ is an edge of T , we have: $f_{T,U}(x') = f_{T,U}(x) + u_i$. See Figure 2.

The *height function* $h_{T,U}$ associated with a lifted tiling $f_{T,U}$, is the component upon e_{d+1} of $f_{T,U}$.

One can easily prove that the definition of lifting of a tiling is consistent since a zonotope is homeomorphic to a closed disk of \mathbb{R}^d . Notice that $f_{T,U}$ is defined for the set of vertices of Z and does not depend on the tiling T chosen.

The two mostly used lifting functions are the *principal lifting function*, defined by $\forall v_i \in V$, $u_i = (v_i, 1)$, and the *k -located function*, where for a fixed integer k , $u_k = (v_k, 1)$ and $\forall i \neq k$, $u_i = (v_i, 0)$. The k -located function has same value on each vertex of a tile whose type does not contain v_k , and differs by 1 at the endpoints of an edge of type v_k . Consequently, the principal function differs by 1 at the endpoints of each edge of the tiling.

Now, since height functions have been defined, one may introduce the important concept of de Bruijn families and sections, widely used in the core of the paper (See [5] for details).

Definition 2 (de Bruijn section, family) Let T be a tiling of a zonotope $Z = (V, M)$, and h_i the i -located function. The de Bruijn family associated with the vector v_i is the set of tiles having v_i in their type. Moreover, the j -th de Bruijn section is the set of tiles whose i -located function is $j - 1$ on one facet, and j on the opposite facet. This section will be noted $S_{\{v_i, j\}}$ (see Figure 2).

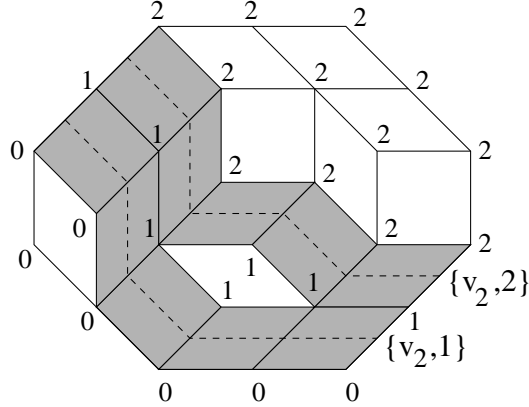

Figure 2: The 2-located height function and two de Bruijn sections.

One sees that a de Bruijn section $S_{\{v_i, j\}}$ disconnects the tiling into two parts, $T_{\{v_i, j\}}^+$ and $T_{\{v_i, j\}}^-$. The first one is composed of tiles whose vertices have i -located function larger than j , and the second corresponds to the tiles whose height function is smaller. Hence, for $j < j'$, we have: $T_{\{v_i, j\}}^- \subseteq T_{\{v_i, j'\}}^-$.

We say that two de Bruijn sections $S_{\{v_i, j\}}$ and $S_{\{v_k, l\}}$ are *parallel* if $v_i = v_k$. The intersection of a set of d de Bruijn sections of T which are pairwise not parallel is a tile of T . The intersection of a set of $d - 1$ de Bruijn sections which are pairwise not parallel is a set of tiles which can be totally ordered in such a way that two consecutive tiles are adjacent. Such an intersection is called a *de Bruijn line*.

2.2 Flips

2.2.1 Tilings of a unitary $d+1$ -zonotope

We first focus on a unitary zonotope of codimension 1. One easily checks that such a zonotope admits exactly two tilings: Let $V = (v_1, \dots, v_{d+1})$ be the sequence of vectors and p_0 be the prototile constructed with the d first vectors: there is a tiling T with a tile t_0 of type p_0 such that $T_{\{v_{d+1}, 1\}}^+$ is empty and $T_{\{v_{d+1}, 1\}}^- = \{t_0\}$, and one tiling T' such that $T_{\{v_{d+1}, 1\}}'^+ = \{t_0 + v_{d+1}\}$ and $T_{\{v_{d+1}, 1\}}'^-$ is empty.

One arbitrarily considers one of these tilings as the *high* position, and the other one as the *low* position.

Remark that T and T' are symmetrical according to the symmetry centered in the vector: $\sum_{1 \leq i \leq d+1} v_i / 2$.

Any pair of tiles of T (or T') are adjacent, since they form a whole de Bruijn line of T . The orders in each de Bruijn line are opposite in T and T' .

2.2.2 Space of tilings

Those tilings of unitary zonotope of codimension 1 can appear, translated, in tilings of a larger zonotope Z . Assume that the tiling T_z of a unitary $d+1$ -zonotope z of codimension 1 appears in a tiling T of Z , translated by a vector v (i. e. formally: $v + T_z \subset T$). We say that

the tiling T' of Z , defined by: $T' = (T \setminus (v + T_z)) \cup (v + T'_z)$, is obtained from T by a *geometric flip*.

The *type* of the flip is the type of z . It will be denoted by the set of indexes of vectors of its support. We have $\binom{D}{d+1}$ types of flips; in particular, for $D = d + 2$, we have D types of flips. The flip is an *up* flip if T_z is the low tiling of z , and its converse is a *down* flip.

The *space of tilings* of a zonotope Z is the symmetric labeled graph whose vertices are the tilings of Z , and two tilings are linked by an edge if they differ by a geometric flip. The label of the edge is the type of the corresponding flip.

The edges of the space of tilings can then be directed by the orientation of flips. One can set a relation between tilings as follows: given two distinct tilings T and T' , we say that $T <_{flip} T'$ if there exists a sequence of up flips leading from T to T' . (i.e. if there exists a directed path from T to T' in the space of tilings, directed as above). We will see later that $<_{flip}$ is really an order relation, which is not *a priori* true, with this definition.

In the following, we label a flip by the indexes of the vectors defining the flipped tiles.

An important result is that flips induce connectivity between all tilings of zonotopes for $d = 2$, i.e. every tiling of a given dimension 2 zonotope Z can be deduced from another tiling of Z by a sequence of flips (see [4, 6, 10] for details). This is an important open question in the case of larger dimensions.

The point is now to study spaces of zonotopal tilings. Despite the fact that rhombic tilings are defined for any dimension, the figures are in dimension 2, for convenience.

2.3 Deletions

Let T be a tiling of support T , and $S_{\{v_i, j\}}$ be a de Bruijn section of T . One can remove the tiles of $S_{\{v_i, j\}}$ and translate all the tiles of $T_{\{v_i, j\}}^+$ by the vector $-v_i$. For $D > d$, the configuration obtained is a tiling of $Z' = (V, M')$ where M' is defined by: $m'_i = m_i - 1$ and $\forall k \neq i, m'_k = m_k$ (except in the special case when $m_i = 1$, in such a case, we have $Z' = (V', M')$ with V' and M' respectively obtained from V and M removing the i^{th} component). Such an operation defines a *deletion* relation on zonotope tilings.

The tiling obtained is denoted by $D_{\{v_i, j\}}(T)$, and for each tile t of T , we state: $D_{\{v_i, j\}}(t) = t$ for t in $T_{\{v_i, j\}}^+$, and $D_{\{v_i, j\}}(t) = t - v_i$ for t in $T_{\{v_i, j\}}^-$.

For consistence, the de Bruijn sections of $D_{\{v_i, j\}}(T)$ according to v_i are assumed to be numbered $1, 2, \dots, j - 1, j + 1, \dots, m_i$. By this way, $D_{\{v_i, j\}}(t)$ and t both are in de Bruijn sections with the same label. We also need this convention for the proposition below, when $v_i = v_k$.

Proposition 2.1 (commutativity of deletions) *Let T be a tiling of a zonotope Z , and two deletions $D_{\{v_i, j\}}$ and $D_{\{v_k, l\}}$. We have:*

$$D_{\{v_i, j\}}(D_{\{v_k, l\}}(T)) = D_{\{v_k, l\}}(D_{\{v_i, j\}}(T))$$

Proof: The tiling T can be partitioned into the five parts below:

- $T_{\{v_i, j\}}^- \cap T_{\{v_k, l\}}^-$: the tiles of this part remain unchanged by the successive deletions, taken in any order,
- $T_{\{v_i, j\}}^+ \cap T_{\{v_k, l\}}^-$: the tiles of this part are translated by $-v_i$ during the successive deletions, taken in any order,

- $T_{\{v_i, j\}}^- \cap T_{\{v_k, l\}}^+$: the tiles of this part are translated by $-v_k$ during the successive deletions, taken in any order,
- $T_{\{v_i, j\}}^+ \cap T_{\{v_k, l\}}^+$: the tiles of this part are translated by $-(v_i + v_k)$ during the successive deletions, taken in any order.
- $S_{\{v_i, j\}} \cup S_{\{v_k, l\}}$: the tiles of this part are removed during the successive deletions, taken in any order.

Thus the order of deletions does not give any change. This gives the commutativity result. \square

A tiling obtained from T by a sequence of p deletions is called a $s-p$ -minor of T .

The pairs $\{v_i, j\}$ can be totally ordered (by the lexicographic order, for example). From this order, the sets $\{\{v_{i_1}, j_1\}, \{v_{i_2}, j_2\}, \dots, \{v_{i_p}, j_p\}\}$ formed by p elements of the type $\{v_i, j\}$ can also be totally ordered. Therefore, the $s-p$ -minors of T can be totally ordered. The sequence of $s-p$ -minors of T is given by this order.

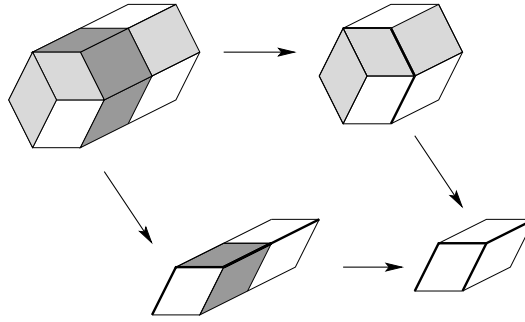

Figure 3: Commutativity of deletions.

Proposition 2.2 Assuming $s \geq d + 2$, every tiling is defined by the sequence of its $s-1$ -minors.

Proof: Let Z be a zonotope, T one of its tilings. Notice that one can easily compute the sequence of $s-2$ -minors of T from the sequence of its $s-1$ -minors. Let $\{v_i, j\}$ and $\{v_{i'}, j'\}$ be two distinct pairs, D_1 and D_2 respectively denote the corresponding deletions, and $D_{1,2}$ denote the corresponding double deletion.

For each tile t' of $D_{1,2}(T)$, one can easily compute the tiles t_1 such that t_1 is in $D_2(T)$ and $D_1(t_1) = t'$, and t_2 such that t_2 is in $D_1(T)$ and $D_2(t_2) = t'$. Precisely, one can compute the pair (ϵ_1, ϵ_2) of $\{0, 1\}^2$ such that $t_1 = t' + \epsilon_1 v_i$ and $t_2 = t' + \epsilon_2 v_{i'}$.

Let t_0 be the tile of T such that $t_1 = D_2(t_0)$. From the commutativity, we also have: $t_2 = D_1(t_0)$ (see Figure 4). Moreover, from the definition of de Bruijn sections, $t_0 = t_2 + \epsilon_1 v_i = t' + \epsilon_1 v_i + \epsilon_2 v_{i'}$: the tile t_0 can be computed from t', t_1 and t_2 .

This gives the result, since for each tile t of T , there are two distinct pairs $\{v_i, j\}$ and $\{v_{i'}, j'\}$ such that t is out of $S_{\{v_i, j\}} \cup S_{\{v_{i'}, j'\}}$ (from the hypothesis: $s \geq d + 2$). \square

Notice that the result is false for: $s = d + 1$. Each d -minor is reduced to a single tile, thus the information about the arrangement of tiles is lost.

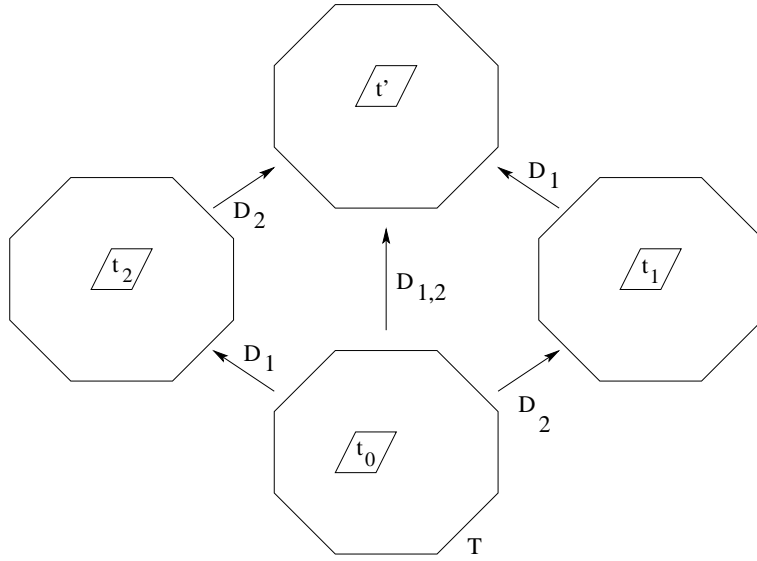

Figure 4: Proof of Proposition 2.2: computation of some tiles of T from $D_2(T)$ and $D_1(T)$

Iterating the proof for $(s - 1)$ -deletion, one obtains the following result as a corollary for proposition 2.2 (see Figure 3).

Corollary 2.3 *Let s' be a integer such that $d + 1 \leq s' \leq s$. Assuming $s \geq d + 2$, every tiling T of zonotope is defined by the sequence of its s' -minors.*

In particular, this is true for $d+1$ -minors.

Proof: Obvious by induction. □

Remark that there are two kinds of $d+1$ -minors: those of codimension 0, the *forced minors*, which are defined by the tiled zonotopes, and those of codimension 1, the *free minors*, which are tilings of unitary zonotopes. Only the free ones contain some information, useful to compute T . This information can be reduced to a single bit, corresponding to the fact that the zonotope is respectively in low or high position. This gives an encoding of zonotope tilings by a word on the alphabet $\{0, 1\}$ of length $\sum_{1 \leq i_1 < i_2 < \dots < i_d \leq D} m_{i_1} m_{i_2} \dots m_{i_d}$ (see Figure 5 for an example).

We define a *set flip* as follows: let T and T' be two tilings of a same zonotope such that all their $d+1$ -minors are the same, except one. we say that T and T' differ by a set flip. We say that the set flip from T to T' is an up flip if the different $d+1$ -minor is in low position in T (and in high position in T').

Proposition 2.4 *let T and T' be two tilings of a zonotope Z . T differs from T' by an upward set flip if and only if T differs from T' by an upward geometric flip.*

The relation $<_{flip}$ defines a partial order.

Proof: It is clear that a geometric flip is a set flip with the same orientation, because it changes locally the positions of $d + 1$ tiles. Since only one $d+1$ -minor contains all these tiles, their positions are changed in only this minor.

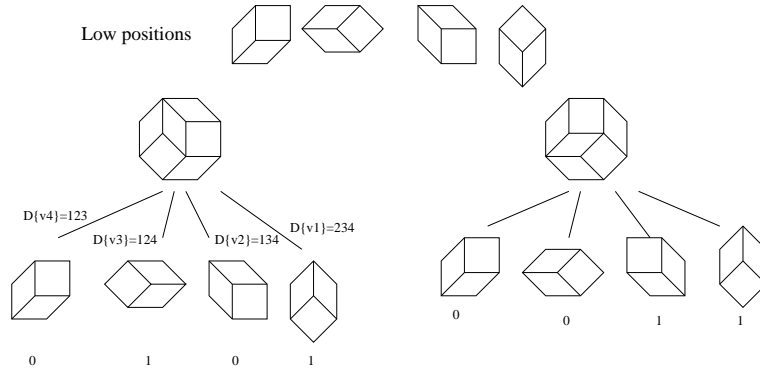

Figure 5: Coding of tilings with $d+1$ -minors.

For the converse part, we first study how a deletion and a set flip act on a fixed de Bruijn line dBL . A deletion (which does not remove the whole de Bruijn line dBL) only removes one tile of dBL and does not change the order in this line for the other tiles. Thus a set flip changes the order on dBL if and only if dBL contains a pair $\{t, t'\}$ of tiles which appear in the flip. Moreover, in this case, the comparison order is changed only for the pair $\{t, t'\}$, since any other pair of tiles appears in a $d+1$ -minor unchanged by the flip. Thus, for consistence of the order, the tiles t and t' necessarily share a whole facet. Thus the flip is actually geometric.

The second part of the Proposition is an obvious corollary of the first part. \square

3 Reconstruction theorem

We are interested in the following problem: given a zonotope Z and a sequence of $d+1$ -tilings (with the good length, and the good vectors), does there exist a tiling T of Z such that the given sequence is the sequence of its $d+1$ -minors ?

We can obviously solve the problem by constructing the (potential) $d+2$ -minors, then the $d+3$ -minors, and so on until the searched tiling is found. If there is a contradiction, the reconstruction is impossible, otherwise the tiling is obtained. But this can give the answer faster, and the following proposition states that the first step is enough to obtain the answer.

Proposition 3.1 *Let $(Zm)_m$ be a sequence of $d+1$ -tilings. There exists a tiling T of a zonotope Z whose sequence of $d+1$ -minors is exactly $(Zm)_m$ if and only if the $d+2$ -minors are compatible, i.e. the sequence of $d+2$ -minors can be correctly constructed.*

Proof: We do the proof by induction on the size s of the zonotope. The case $s = d + 2$ is obvious.

Let $s > d + 2$. Consider the prefix of the sequence $(Zm)_m$ formed by $d+1$ -tilings where the tiles of the (potential) de Bruijn section $\{v_D, m_D\}$ do not appear (since it is assumed that the deletion $D_{\{v_D, m_D\}}$ has been done). This subsequence is, by assumption, the sequence of $d+1$ -minors of a tiling T' of size $s - 1$.

On the other hand, for each tile t of T' , there exists a $d+1$ -tiling T_t containing t and d tiles of the de Bruijn section $\{v_D, m_D\}$. Hence t can be assigned a $+$ or $-$ sign, depending on its

position in T_t , relatively to $S_{\{v_D, m_D\}}$ (+ if the D -located height function of t is 1, $-$ if it is 0). Let T'^+ be the part of T' formed by the tiles marked $+$ and T'^- the part formed by tiles marked $-$.

Let us now consider a straight line l directed by v_D . We claim that, following l in the sense of v_D , one first meets tiles marked $-$, then tiles marked $+$. This means that T'^+ and T'^- are convex along v_D , i.e. that the new de Bruijn section can be inserted correctly in T' , thus leading to a new tiling T . Two cases may occur:

- l only meets facets and interior parts tiles of T' . Consider two tiles of T' , say t_1 and t_2 , which share a facet, and such that t_2 follows t_1 in the succession of tiles crossed by l in the direction of v_D . There exists a $d+2$ -minor T_{d+2} containing (tiles corresponding to) tiles of $\{v_D, m_D\}$ and tiles t_1 and t_2 . There are only three possible sign assignment for (t_1, t_2) , since the assignment: $+$ for t_1 and $-$ for t_2 , is impossible ; otherwise the tile t_3 of type $\{\tau\} \cup \{v_D\}$ (where τ denotes the set of common vectors in the types of t_1 and t_2) cannot be placed in the $d+2$ -minor T_{d+2} (see Figure 6).

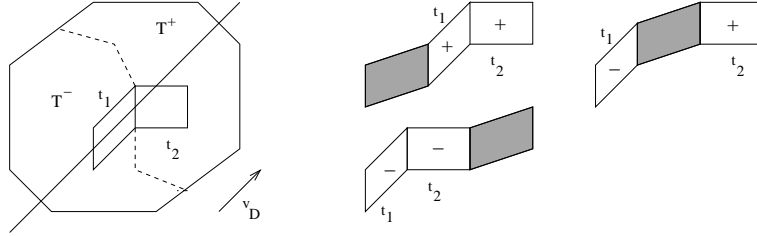

Figure 6: The three possible sign assignments for t_1 and t_2 , from the possible positions in the de Bruijn line of T_{d+2} .

- l meets a face f of the tiling T' of dimension lower than $d - 1$. Then, there are two tiles t_1 and t_2 with the same hypothesis as in the previous case, but sharing only the face f . There exists a parallel line l' , arbitrarily close to l , satisfying the hypothesis of the previous case, and crossing both t_1 and t_2 (but t_1 and t_2 are not necessarily consecutive along l' . See Figure 7). Thus the assignment: $+$ for t_1 and $-$ for t_2 , is impossible.

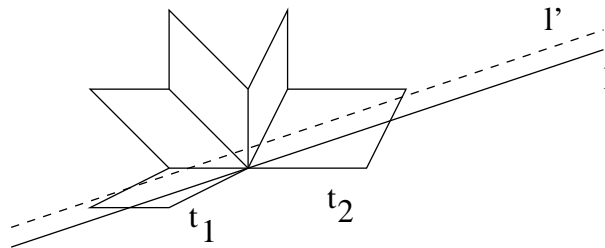

Figure 7: A line l crossing a vertex, and the auxiliary line l'

Hence T'^+ and T'^- are consistent according to $\{v_D, m_D\}$, allowing to translate the part

T'^+ by v_D , in order to insert the de Bruijn section $S_{\{v_D, m_D\}}$. The tiling T obtained (such that $T'^+ = T_{\{v_D, m_D\}}^+ + v_D$ and $T'^- = T_{\{v_D, m_D\}}^-$) is the one searched, which ends the proof. \square

4 Representation in codimension 2

From this section, we limit ourselves to the case when $D = d + 2$. A type of a flip will be labeled by the sequence of indexes of the $d + 1$ vectors involving in it, or, for convenience, by the overlined index by the missing vector (for example, a flip whose support is the unitary zonotope constructed with the first $d + 1$ vectors is labeled by $12\dots d + 1 = \overline{d + 2}$).

As seen formerly, the zonotopal tilings can be easily encoded by considering their minors. More precisely, one tiling is defined by the set of high or low positions of all (free) $d+1$ -minors. We will now describe a representation tool for zonotope tilings based on the minor structure. But, before doing it, we need more knowledge about $d+2$ -zonotopes.

4.1 The basic $d+2$ -zonotopes

In dimension d , there exists two basic kinds of $d+2$ -zonotopes of dimension d whose tiling is not forced: either all vectors have multiplicity 1 (codimension 2), or there is one vector of multiplicity 2 (codimension 1). We first precisely study these cases.

4.1.1 The $d+2$ -zonotope of codimension 1

Proposition 4.1 *The space of tilings of the zonotope Z_i of codimension 1 with the vector v_i of multiplicity 2 (and the d other ones of multiplicity 1) contains three tilings and is a chain of length 2.*

Proof: In each tiling, there exists a unique tile t which is not element of $S_{\{v_i, 1\}} \cup S_{\{v_i, 2\}}$. Since $T_{\{v_i, 1\}}^- \subseteq T_{\{v_i, 2\}}^-$, we have three tilings:

- one tiling with $t \in T_{\{v_i, 1\}}^-$,
- one tiling with $t \in T_{\{v_i, 2\}}^+$,
- one tiling with $t \in T_{\{v_i, 2\}}^- \setminus T_{\{v_i, 1\}}^-$.

The directed edges corresponding to flips are obvious (remark that both the free $d+1$ -minors of Z_i are of the same type, which gives the chain) (see Figure 8). \square

4.1.2 The unitary $d+2$ -zonotope

We first need more information about the structure of tilings of unitary $d+1$ -zonotopes. This is given by the lemma below.

Lemma 4.2 *Let T be a tiling of unitary $d+1$ -zonotope, and v be a vector not in the type of Z . We define a tournament $G_{(T, v)}$ on the tiles of T saying that (t_1, t_2) is an arc of $G_{(T, v)}$ if the vector v crosses their common facet passing from t_1 to t_2 (see Figure 9).*

The tournament $G_{(T, v)}$ is actually a total order.

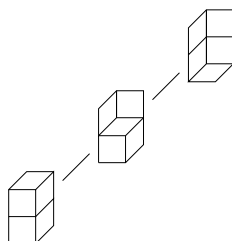

Figure 8: Space of tilings of a codimension 1 zonotope with one duplicated vector.

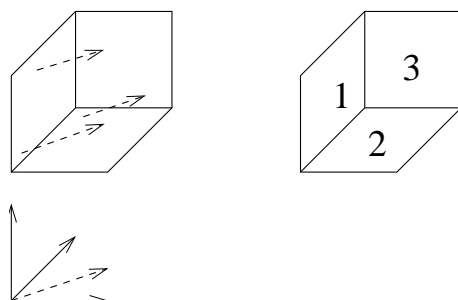

Figure 9: A codimension 1 tiling, the added vector (dashed), and the ordering of tiles according to this vector.

Proof: Since all pairs of tiles are linked, we only have to prove that $G_{(T,v)}$ has no cycle of length 3. We prove it reducing the problem to the case: $d = 2$, for which the proof is easy by a case by case analysis.

In higher dimension, notice that, since $D = d + 1$, the types of three given tiles t_1, t_2 and t_3 contain $(d + 1) - 3 = d - 2$ common vectors. Let p denote the orthogonal projection on the 2-dimensional space which is orthogonal to the $d - 2$ common vectors. The projections $p(t_i)$ are parallelograms, and we have $(t_i, t_j) \in G_{(T,v)}$ if and only if $(p(t_i), p(t_j))$ is in $G_{H,p(v)}$; where H denotes the hexagon covered by the parallelograms $p(t_i)$ (H is really a hexagon, since otherwise the tiles t_i cannot be pairwise adjacent). This gives the result, since $G_{p(v)}$ is not a cycle. \square

Proposition 4.3 *The space of tilings of a unitary $d+2$ -zonotope is a cycle of length $2(d + 2)$, and each possible label is given to a pair of edges, which are opposite in the cycle.*

Proof: let T be a tiling of the unitary zonotope $Z = ((v_1, v_2, \dots, v_{d+2}), (1, 1, \dots, 1))$. From the above lemma applied on the support Z' of $D_{\{v_{d+2}, 1\}}(T), T_{\{v_{d+2}, 1\}}^-$ is an initial segment of the order induced by v_{d+2} on tiles of $D_{\{v_{d+2}, 1\}}(T)$.

Conversely, given a tiling T' whose support is Z' , and an initial segment T' (according to the order induced by v_{d+2}), one easily constructs a tiling of Z : tiles which are not in the initial segment are translated by v_{d+2} , and tiles of $S_{\{v_{d+2}, 1\}}$ are inserted in the remaining space. There exists $d + 2$ possible initial segments for a set of $d + 1$ elements, thus, since Z' admits two tilings, there exists $2(d + 2)$ tilings of Z .

Now, take a tiling of T , i. e. a tiling T' of the zonotope Z' and I one initial segment of it. What are the possible flips from T ? First assume that the initial segment is proper (i. e.

neither empty nor equal to T'). There are two possible flips, which correspond to adding or removing one tile in I . No other flip is possible because of the relative position of tiles given by the order on tiles of T' (the flip only using tiles of T' is not possible because of the cut by $S_{\{v_{d+2},1\}}$).

A similar argument holds for the other case. If I is empty, two flips are possible, one which corresponds to adding the first tile in I , the other one only uses tiles of T' . If $I = T'$, two flips are possible, one which corresponds to removing the last tile in I , the other one only uses tiles of T' . This gives the result, using the symmetry of both tilings of Z' to get the labels of opposite edges. \square

4.1.3 Order convention

We fix a basic tiling T_0 of the unitary $d+2$ -zonotope. We enforce the convention of low and high position, defining low positions of $d+1$ -tilings as tilings which are elements of the sequence of $d+1$ -minors of T_0 . With this convention, T_0 is the lowest tiling of the unitary $d+2$ -zonotope; T_1 , the opposite tiling in the cycle, is the largest tiling. The space is formed by two directed chains from T_0 to T_1 , which only meet at their endpoints. Up to vector renumbering, it can be assumed that, from T_0 to T_1 the sequence of successive labels in a chain is $(\overline{d+2}, \overline{d+1}, \dots, \overline{1})$ and the sequence is $(\overline{1}, \overline{2}, \dots, \overline{d+2})$ for the other chain (see Figure 10).

We can encode each tiling by its position on the cycle as follows: the tiling at the end of the path issued from T_0 , whose sequence of labels is $(\overline{d+2}, \overline{d+1}, \dots, \overline{d+3-i})$, is denoted by T_{iL} (informally, T_{iL} is in i_{th} position on the left chain), and the tiling at the end of the path, issued from T_0 , whose sequence of labels is $(\overline{1}, \overline{2}, \dots, \overline{i})$, is denoted by T_{iR} (informally, T_{iR} is in i_{th} position on the right chain).

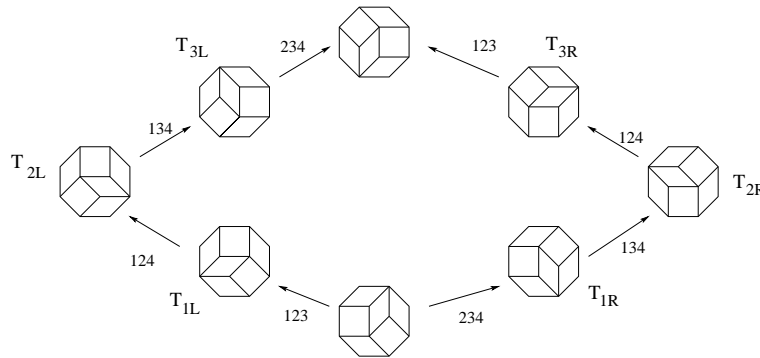

Figure 10: The order associated with a unitary octagon.

4.2 Tiling diagrams

We can now precisely explain how we represent a fixed tiling T .

4.2.1 Points

In our representation, each $d+1$ -minor is associated to a *point*. Each point p is defined by two parameters. We first have a *coordinate vector*, element of \mathbb{Z}^{d+2} , which indicates the position of the $d+1$ -minor in the sequence of minors: The i^{th} component, denoted by i_p , of this vector is equal to j if the deletion according to the pair $\{v_i, j\}$ has not been done to obtain the corresponding $d+1$ -minor; the component i_p is null if, for each integer j such that $1 \leq j \leq m_i$, the deletion according to $\{v_i, j\}$ have been done (thus there exists exactly one null component). Remark that a similar vector coordinate will also be given to each $d+2$ -minor whose support is a unitary zonotope: the only difference is that there is no null component.

The other parameter is a *color*, which is white if the $d+1$ -minor is in low position, or black if in high position.

The important thing for reconstructing a tiling T is the set of coloring constraints which are given by the sequence of $d+2$ -minors. We now explain how coloring constraints are expressed.

4.3 Arrows

Two points correspond to the pair of minors of a same $d+2$ -minor (the support of this $d+2$ -minor is a $d+2$ -zonotope of codimension 1) if and only if they only differ by one non-null coordinate.

From what has been seen about these $d+2$ -tilings, there exists exactly three allowed colorings of such a pair of points, corresponding to tilings of a $d+2$ -zonotope.

The forbidden coloring uses both colors. We put an arrow in such a way that the origin of the arrow is black in the forbidden coloring (and the end of the arrow is black). Thus, the three allowed colorings of the tiled $d+2$ -zonotope are the fully black one, the fully white one, and the coloring with the origin of the arrow being black and the other point being white. This is the *first constraint*.

The arrow is labeled by the index of the coordinate which is different for the points.

The arrows of the diagram give the *covering relation*: a point p is covered by a point p' if there exists an arrow such that p is the origin of the arrow, and p' its endpoint.

4.4 Lines

Fix a $d+2$ -minor whose support is a unitary $d+2$ -zonotope. A point corresponds to a $d+1$ -minor of this $d+2$ -tiling if and only if its coordinate vector is obtained replacing one coordinate of the $d+2$ -minor by 0.

Such points are linked by *line*, i. e. they form a sequence ordered in the same way as flips are ordered in a path between T_0 and T_1 . From what has been seen about tilings of unitary $d+2$ -zonotopes, with the order convention, the black points have to form a final or initial segment (i. e. a suffix or a prefix) of the line. This is the *second constraint*.

Hence, tilings of zonotopes are presented as *diagrams* on which lines represent unitary $d+2$ -zonotopes, and arrows represent $d+2$ -zonotopes of codimension 1 (see Figure 11). Notice that arrows and lines only depend on the support of the tiling. From the reconstruction theorem, a coloring of points induces a tiling if and only if it respects the constraints above.

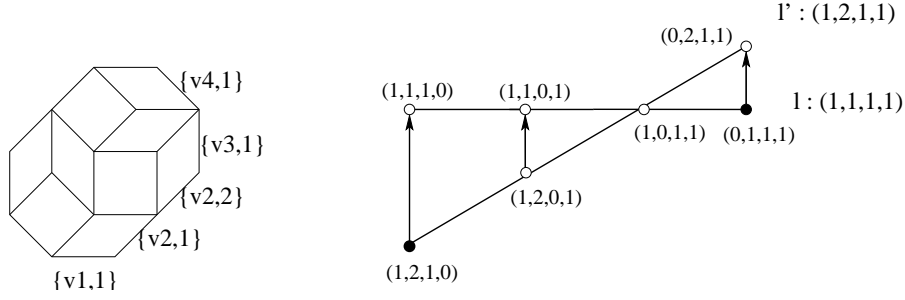

Figure 11: A tiling and the associated diagram (notice the orientation of the arrows, according to the inversion property).

4.5 Properties of diagrams

First notice that the highest diagram (i. e. with all points black) and the lowest one (i. e. with all points white) are tilings. We will use two main properties of diagrams.

Lemma 4.4 (inversion property) *Let $l = (p_1, p_2, \dots, p_{d+2})$ and $l' = (p'_1, p'_2, \dots, p'_{d+2})$ be two distinct lines such that there exists a unique integer i such that $p_i = p'_i$.*

Assume p_1 is covered by p'_1 . For any integer j such that $1 \leq j < i$, p_j is covered by p'_j , and for any integer j such that $i < j \leq d+2$, p'_j is covered by p_j (see Figure 11 for an illustration of this property).

Of course, a similar property holds when it is assumed that p_{d+2} is covered by p'_{d+2} .

Proof: Consider the $d+2$ -minor whose sequence of minors corresponds to points p_i and p'_i . Its support Z_0 has codimension 2, its multiplicity is 1 according to any vector v_j , for $j \neq i$ and its multiplicity is 2 according to the vector v_i .

Consider the tiling $T_{wh.}$ of Z_0 corresponding to the fully white coloring. This tiling has two minors of codimension 2 which are obtained by a deletion according to v_i . By definition, both these minors are equal to T_0 . That means that there is no tile between both de Bruijn lines according to v_i of $T_{wh.}$

By a sequence of flips, one can move the de Bruijn lines in such a way that each tile (whose type does not contain v_i) of the resulting tiling T_{inside} is between both de Bruijn lines according to v_i (see Figure 12). This is done using two successive sequences of flips, one labeled by $(\bar{1}, \bar{2}, \dots, \bar{i-1})$ used to move a de Bruijn line, and the other one labeled by $(\overline{d+2}, \overline{d+1}, \dots, \overline{i+1})$ to move the other de Bruijn line.

Now, the set of black points is one of the sets: $\{p_1, p_2, \dots, p_{i-1}, p'_{i+1}, p'_{i+2}, \dots, p'_{d+2}\}$ or $\{p'_1, p'_2, \dots, p'_{i-1}, p_{i+1}, p_{i+2}, \dots, p_{d+2}\}$. But the second set is not possible, from our assumption about the arrow from p_1 to p'_1 (if p'_1 is black, then p_1 is necessarily black).

Thus the set of black points is $\{p_1, p_2, \dots, p_{i-1}, p'_{d+2}, p'_{d+1}, \dots, p'_{i+1}\}$, which forces the sense of arrows, and gives the result. \square

The inversion property allows to define the labeled *line graph* whose vertices are the lines of the diagram. Let $l = (p_1, p_2, \dots, p_{d+2})$ and $l' = (p'_1, p'_2, \dots, p'_{d+2})$ be two distinct lines. The pair (l, l') is an edge of the line graph if and only if that there exists a unique integer i such

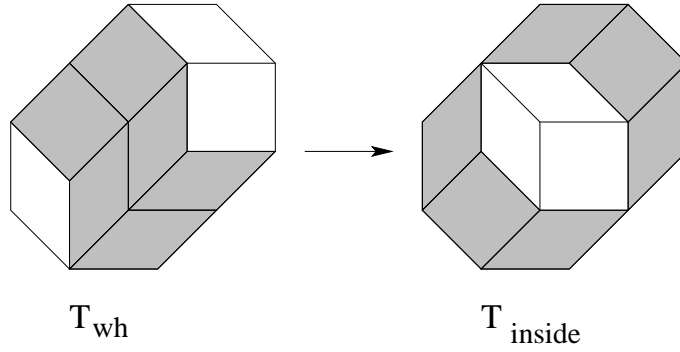

Figure 12: The tilings T_{wh} and T_{inside} .

that $p_i = p'_i$. This edge is labeled by i^- if there is an arrow of the diagram from p_1 to p'_1 , or there is an arrow from p'_{d+2} to p_{d+2} ; otherwise the edge is labeled by i^+ .

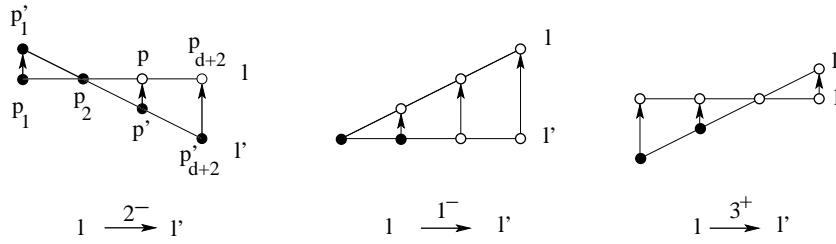

Figure 13: Examples of edges of the line graph.

The line graph only depends on the support of the tiling, i. e. two tilings with the same support induce the same line global line graph (informally, the sign included in the label indicates the sense of rotation to pass from l to l').

Lemma 4.5 (consistence property) *Let (l_1, l'_1) and (l_2, l'_2) be two edges of the line graph whose labels are elements of the set $\{i^+, i^-\}$. Both these edges have the same label if and only if: $(i_{l_1} - i_{l'_1})(i_{l_2} - i_{l'_2}) > 0$.*

Proof: Consider the zonotope Z_0 of codimension 2, with multiplicity 1 for any vector v_j such that $j \neq i$ and multiplicity 2 for v_i . As for the previous lemma, each pair (l_k, l'_k) induces a tiling of Z_0 .

Consider the tiling $T_{wh.}$ of Z_0 corresponding to the fully white coloring. Each de Bruijn section of $T_{wh.}$ according to v_i is numbered by an element of the set $\{i_{l_k}, i_{l'_k}\}$, according to the pair (l_k, l'_k) . Moreover, the lowest index of each pair $\{i_{l_k}, i_{l'_k}\}$ is given to the same de Bruijn section (and the largest index given to the other de Bruijn section).

From this tiling, as in the previous lemma, one can do a sequence of flips in order to obtain the tiling T_{inside} . Looking at the set of black points for each pair of lines, the result is obtained, considering the set of labels of flips in each case. \square

5 Structure of the order in codimension 2

We will now use our representation to obtain some structural results on the space of tilings. Our main theorem is stated below:

Theorem 5.1 *Let (T, T') be a pair of tilings with the same support, and B_T (respectively $B_{T'}$) be the set of black points for T (respectively T') of the diagram.*

We have: $T \leq T'$ if and only if: $B_T \subseteq B_{T'}$.

The direct part of the theorem is obvious. To prove the converse, we consider two tilings T and T' such that $B_T \subseteq B_{T'}$. The proof uses two lemmas which will be detailed first.

For convenience, we first introduce some vocabulary. The points in B_T are said *wholly black*, those which are not elements of $B_{T'}$ are *wholly white*, the remaining points are *positive*. A positive point is *critical* if it is only covered by fully white points. A positive point p is *removable* for the pair (T, T') if $B_{T'} \setminus \{p\}$ is still the set of black points of a diagram of tiling. A removable point is necessarily critical. We have to prove that (when $T \neq T'$) there exists a removable point.

If we only consider a tiling, then the lowest one is, by default, the fully white tiling. We speak of *absolutely removable* point.

5.1 Cluster reduction

The *cluster* F_p generated by a point p is the set of lines passing through p . From Lemma 4.5, the covering relation induces a total order over the points of F_p having same type. Moreover, a cluster can be seen as the diagram of a zonotope Z_p (with all multiplicities except one being unitary), and the previous colorings, restricted to F_p , are tilings, say T_p and T'_p , of Z_p . Since $B_T \subseteq B_{T'}$, we have: $B_{T_p} \subseteq B_{T'_p}$.

The point p is covered by no other point of F_p . Thus, if p is a critical point for (T, T') , then p becomes removable in F_p , for the pair (T_p, T'_p) .

Lemma 5.2 *Let p be a point removable in F_p for the pair (T_p, T'_p) , and p' be a positive point which covers p . The point p' is removable in $F_{p'}$ for the pair $(T_{p'}, T'_{p'})$.*

Proof: Consider a line l' passing through p' . There exists a line l passing through p and meeting l' (since p' covers p they differ by only one coordinate) on a common point p'' . Let (T_l, T'_l) denote the pair of tilings of the unitary $d+2$ -zonotope induced by (T, T') from the colorings of the line l . From the inversion property, one sees (by an easy case by case analysis) that if p is removable on l for the pair (T_l, T'_l) , then p' is removable on l' for the pair $(T_{l'}, T'_{l'})$ (see Figure 14 for an example; one can check that other configurations lead to the same result). Thus p' is removable in $F_{p'}$. \square

From this lemma, it suffices to prove that there exists a point p which can be removed in F_p , to prove Theorem 5.1. We will do it now, using an appropriate notion: the obstacle graph.

5.2 Obstacle graph

We now present the main tool used for the proof of Theorem 5.1.

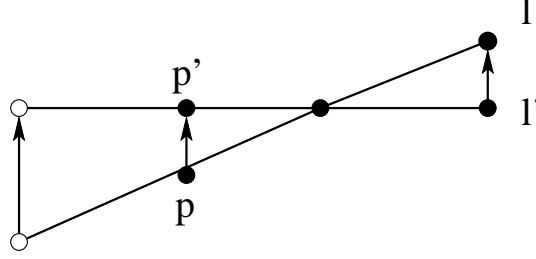

Figure 14: An example for the proof of Lemma 5.2
: if p is removable for l , then p' is removable for l' .

Definition 3 (Obstacle graph) The obstacle graph is the labeled directed graph G where:

- the vertices of G are the tilings (or corresponding lines of colored points) of the unitary $d+2$ -zonotope (except T_0),
- (T, T') is an edge of G if there exists a $d+3$ -tiling T_{aux} of codimension 2 such that:
 - T is a minor of T_{aux} corresponding to a line $l = (p_1, p_2, \dots, p_{d+2})$ included in the diagram of T_{aux} ,
 - T' is a minor of T_{aux} corresponding to the other line $l' = (p'_1, p'_2, \dots, p'_{d+2})$ included in the diagram of T_{aux} ,
 - the unique point p_i such that $p_i = p'_i$ is (absolutely) removable in l , but is not (absolutely) removable in l' .
- If $p_1 = p'_1$, then the edge (T, T') is labeled by 1^+ . If the integer i such that $p_i = p'_i$ is not equal to 1, then the edge (T, T') is labeled by i^- if p_1 is covered by p'_1 , and labeled by i^+ otherwise.

The only edges of the obstacle graph are those listed below (see Figure 15):

- for each pair (k, j) such that $1 \leq k < j \leq d+2$, the pair (T_{kL}, T_{jL}) is an edge labeled by k^- (except the pair $(T_{1L}, T_{(d+2)L})$ which is not an edge),
- for each pair (k, j) such that $1 < k < d+2$ and $d+3 < j+k$, the pair (T_{kL}, T_{jR}) is an edge labeled by k^- ,
- for each pair (k, j) such that $1 \leq k < j \leq d+2$, the pair (T_{kR}, T_{jR}) is an edge labeled by k^+ (except the pair $(T_{1R}, T_{(d+2)R})$ which is not an edge),
- for each pair (k, j) such that $1 < k < d+2$ and $d+3 < j+k$, the pair (T_{kR}, T_{jL}) is an edge labeled by k^+ ,
- for each integer j such that $1 \leq j < d+2$, the pair (T_1, T_{jL}) (we recall $T_1 = T_{(d+2)L} = T_{(d+2)R}$) is an edge labeled by 1^+ , and the pair (T_1, T_{jR}) is an edge labeled by $d+2^-$,

Lemma 5.3 We say that a directed cycle in the obstacle graph is equilibrated if the sequence of labels of its edges is such that, for each integer i such that $1 \leq i \leq d+2$, the label i^+ appears in the sequence if and only if i^- also appears.

The obstacle graph has no (non-empty) equilibrated cycle.

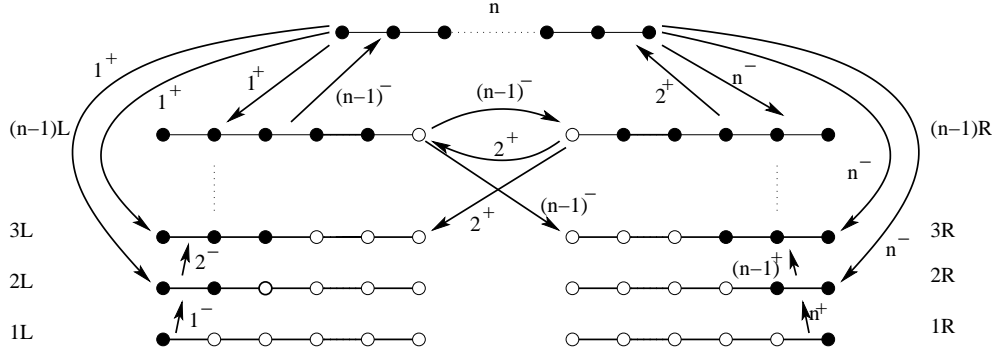

Figure 15: The obstacle graph.

Proof: Assume we try to find an equilibrated cycle. The vertices T_{1L} and T_{1R} cannot be in the cycle, since they have no incoming edge. Then we remove them and all the edges adjacent to them, i.e. all the edges labeled by 1^- and $(d+2)^+$. Because of the equilibration requirement for the cycle, we remove all the edges labeled by 1^+ or $(d+2)^-$.

We start again with vertices T_{2L} and T_{2R} . Since edges labeled by 1^+ and $(d+2)^-$ have been removed, T_{2L} and T_{2R} have no more incoming edges. Then they can be removed, as well as their outgoing edges, which are all the edges labeled by 2^- and $(d+1)^+$. For equilibration requirements, one can also remove all edges labelled 2^+ and $(d+1)^-$.

The procedure going on, one can check that the whole graph will be deleted. Then there exists no equilibrated cycle. \square

5.3 End of the proof

We now have the tools necessary to finish the proof of Theorem 5.1.

Proof: (of Th. 5.1). As it has been said before, the direct part is obvious. For the converse part, from the cluster reduction, it suffices to find a point p removable in F_p according to the pair (T_p, T'_p) .

For each line l , we say that a point p is *removable in l* if p is removable for the pair (T_l, T'_l) of tilings of the unitary $d+2$ -zonotope induced by the pair (T, T') from the colorings of l .

If $T \neq T'$, there exists a line l_0 of the diagram associated to T containing a positive point p_0 , which can be assumed to be removable in l_0 . If p_0 is removable in F_{p_0} for (T_{p_0}, T'_{p_0}) , then we are done.

Otherwise, there exists a line l_1 passing through p_0 , such that p_0 cannot be removed in l_1 . In this case, there necessarily exists another point p_1 which is removable in l_1 . If p_1 is removable in F_{p_1} for the pair (T_{p_1}, T'_{p_1}) , then we are done. Otherwise, we can repeat the process.

Assume that there is no point p removable in F_p for the pair (T_p, T'_p) . With this hypothesis, the process can be infinitely repeated to construct a sequence $(l_i)_{i \geq 0}$ of lines. Thus there exists a finite subsequence $(l_i)_{i_1 \leq i \leq i_2}$ which is a cycle, i. e.: $l_{i_1} = l_{i_2}$.

This cycle is actually a cycle C_{line} of the line graph. The main idea is the following:

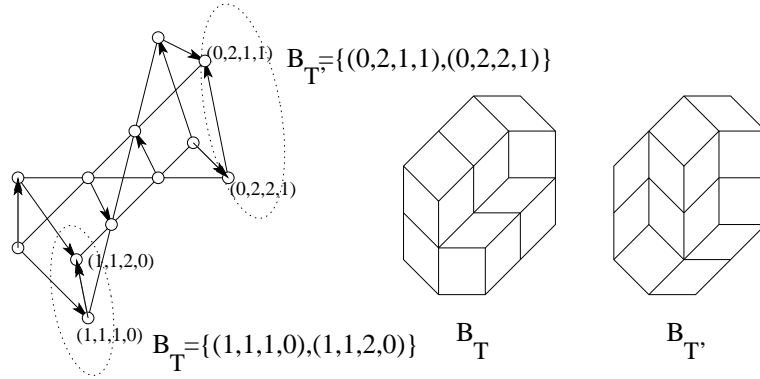

Figure 16: The underlying diagram for two tilings having two incomparable suprema.

From the cycle C_{line} , one canonically obtains a cycle $C_{obstacle}$ of the obstacle graph, from the mapping which associates to each line l of the diagram, the (coloring given by the) tiling T'_l of the $d+2$ -unitary zonotope. The edge labeling is preserved: if (l, l') is an edge of C_{line} , then the edge $(T'_l, T'_{l'})$ obtained by mapping has the same label as (l, l') .

From the study of the flip graph, the cycle $C_{obstacle}$ is not equilibrated. One can assume without loss of generality, that the label j^+ appears in the directed cycle, but label j^- does not appear. That means that, following the cycle C_{line} , the j^{th} coordinate changes always in the same direction. This cannot arise. Thus the process must stop with a line l_i and a point p_i which can be removed. \square

5.4 Consequences

5.4.1 Diameter and connectivity

From Theorem 5.1, we obtain a structure of graded poset for the space of tilings. The maximal element is the fully black tiling, the minimal element is the fully white tiling. The rank of a tiling is the number of black points of its diagram. The height of the order is the sum: $\sum_{1 \leq i_1 < i_2 < \dots < i_{d+1} \leq d+2} m_{i_1} m_{i_2} \dots m_{i_{d+1}}$. This height above is also the diameter of the space of tilings.

It was known before that for $d = 2$, or $D - d = 1$, the space of tilings is a graded poset (See [9, 3]). As a corollary of Theorem 5.1, we obtain an extension of these results to $D - d = 2$, i. e. the codimension 2 case.

For $D - d = 2$, the graded poset given is not a lattice in the general case. See a counterexample in Figure 16. This is an important difference with the case $D - d = 1$.

5.4.2 Uniform random sampling

Consider the Markov process on tilings defined as follows: choose uniformly at random a point p of the diagram, and a color c (white or black). If the diagram obtained from T giving the color c to p is the diagram of a tiling T_1 then replace T by T_1 .

Clearly, this process satisfies the hypothesis for ergodicity since the space of tilings is connected and there exists some loops in the process. Thus the probability distribution p_n obtained after n steps (starting from any distribution, for example, one can take for p_0 the

Dirac distribution, concentrated on the wholly white tiling) converges to the uniform distribution.

6 Perspectives

The decomposition method used here gives an interesting approach for rhombic tilings. The associated diagrams give nontrivial results on the spaces of tilings.

The connectivity result presented here looks really encouraging for further studies, and extensions of the flip graph may give more information on the sets of tilings, for example flip distances between tilings.

Moreover, the method seems to apply for larger codimensions, or for more general polytopes.

References

- [1] F. Bailly, N. Destainville, R. Mosseri, and M. Widom, *Arctic octahedron in three-dimensional rhombus tilings and related integer solid partitions*, Journal of Statistical Physics **109** (2002) 945-965.
- [2] A. Björner, M. Las Vergnas, B. Sturmfels, N. White, and G. M. Ziegler, *Oriented matroids*, Encyclopedia of Mathematics, vol. 46, Cambridge University Press, 1999, Second Edition.
- [3] F. Chavanon and E. Rémila, *Contractions of octagonal tilings with rhombic tiles*, Tech. report, ENS Lyon, 2003, RR2003-44.
- [4] Nicolas Destainville, *Entropie configurationnelle des pavages aléatoires et des membranes dirigées*, Ph.D. thesis, University Paris VI, 1997.
- [5] N.G. de Bruijn, *Dualization of multigrids*, J. Phys. France **C(47)** (1981), 3–9.
- [6] Serge Elnitsky, *Rhombic tilings of polygons and classes of reduced words in Coxeter groups*, Journal of Combinatorial Theory **77** (1997), 193–221.
- [7] S. Felsner and H. Weil, *A theorem on higher bruhat orders*, Discrete and Computational Geometry **23** (2003), 121–127.
- [8] S. Felsner and G.M. Ziegler, *Zonotopes associated with higher bruhat orders*, preprint.
- [9] S. Felsner, *On the number of arrangements of pseudolines*, Discrete Computational Geometry **18** (1997), 257–267.
- [10] Richard Kenyon, *Tiling a polygon with parallelograms*, Algorithmica **9** (1993), 382–397.
- [11] V. Reiner, *The generalized baues problem*, 38, MSRI Book, Cambridge University Press, 1999.
- [12] Jürgen Richter-Gebert and Günter Ziegler, *Zonotopal tilings and the Bohne-Dress theorem*, Contemporary Mathematics **178** (1994), 211–232.

- [13] W.P. Thurston, *Conway's tiling groups*, American Mathematical Monthly **97** (1990), 757–773.
- [14] Günter Ziegler, *Lectures on polytopes*, Graduate Texts in Mathematics, Springer-Verlag, 1995.
- [15] G. Ziegler, *Higher Bruhat orders and cyclic hyperplane arrangements*, Topology **32** (1992), 259–279.