



HAL
open science

Configurations des huit premiers satellites de Saturne pour 1993

J.-E. Arlot, Th. Derouazi, Ch. Ruatti

► **To cite this version:**

J.-E. Arlot, Th. Derouazi, Ch. Ruatti. Configurations des huit premiers satellites de Saturne pour 1993. [Rapport de recherche] Institut de mécanique céleste et de calcul des éphémérides(IMCCE). 1992, 33 p., figures. hal-01478615

HAL Id: hal-01478615

<https://hal-lara.archives-ouvertes.fr/hal-01478615>

Submitted on 28 Feb 2017

HAL is a multi-disciplinary open access archive for the deposit and dissemination of scientific research documents, whether they are published or not. The documents may come from teaching and research institutions in France or abroad, or from public or private research centers.

L'archive ouverte pluridisciplinaire **HAL**, est destinée au dépôt et à la diffusion de documents scientifiques de niveau recherche, publiés ou non, émanant des établissements d'enseignement et de recherche français ou étrangers, des laboratoires publics ou privés.

SATELLITES DE SATURNE

I à VIII

CONFIGURATIONS POUR 1993

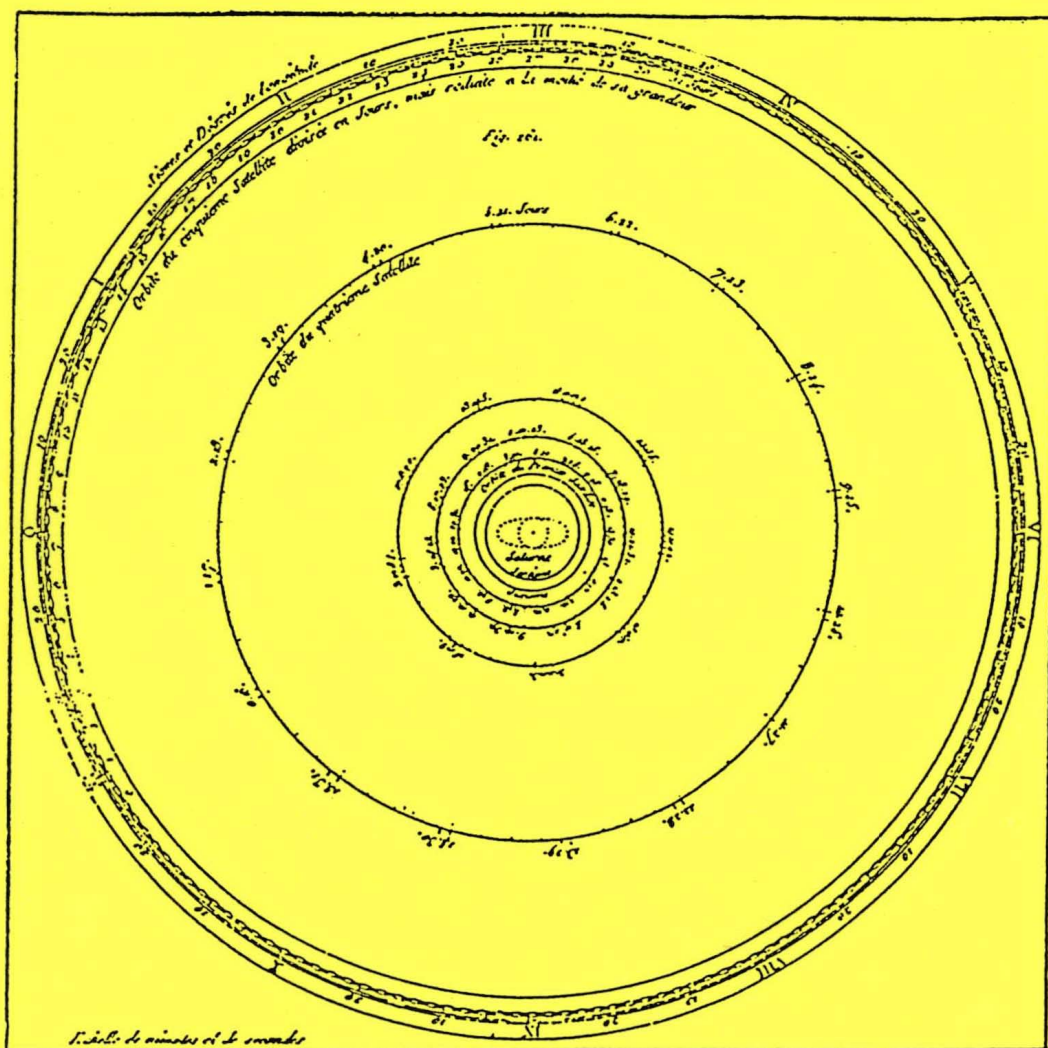

Supplément à la CONNAISSANCE DES TEMPS

à l'usage des observateurs

Bureau des Longitudes, UA CNRS

Paris, juin 1992

**CONFIGURATIONS DES HUIT PREMIERS
SATELLITES DE SATURNE
POUR 1993**

**CONFIGURATIONS OF THE FIRST EIGHT
SATELLITES OF SATURN
FOR 1993**

Bureau des Longitudes, 77 avenue Denfert-Rochereau, F-75014 PARIS.
Supplément à la *Connaissance des Temps* à l'usage des observateurs.
Rédaction et calculs : J.E. ARLOT, Th. DEROUAZI, Ch. RUATTI.

Paris, juin 1992

USAGE DES CONFIGURATIONS

Les configurations permettent d'identifier les satellites et de déterminer leur position en coordonnées tangentielles équatoriales relatives à Saturne avec la précision suivante (pour une lecture des courbes à 0,5 millimètre près) :

| | | | |
|-----|-----------|------|----------|
| I | : 2 à 10" | V | : 2 à 3" |
| II | : 2 à 8" | VI | : 2 à 3" |
| III | : 2 à 6" | VII | : 2 à 3" |
| IV | : 2 à 4" | VIII | : 2 à 3" |

L'exemple suivant montre comment procéder :

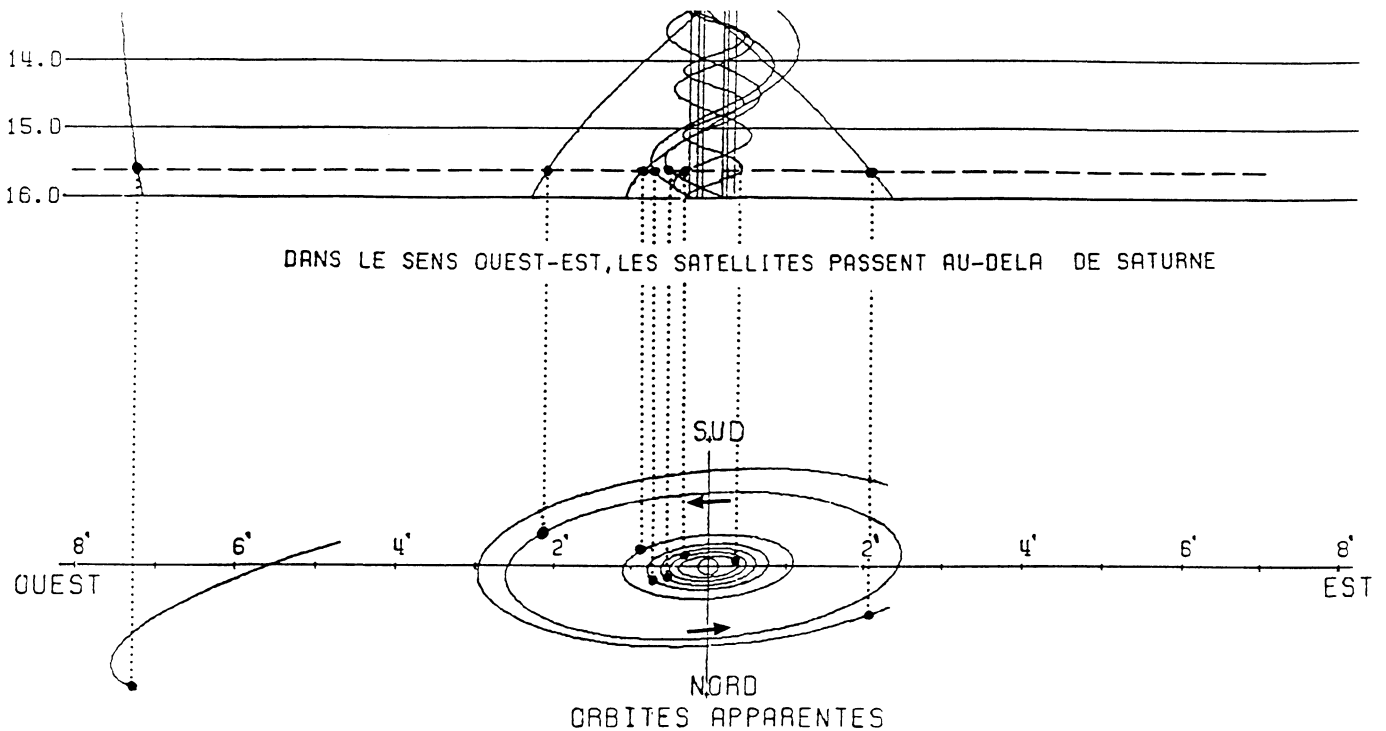

On reporte en abscisse sur l'axe ouest-est les distances $\Delta\alpha \cos\delta$ mesurées, pour la date voulue, sur les courbes. L'ordonnée est donnée par les orbites apparentes. L'indétermination avant/arrière est levée grâce au sens de rotation des satellites.

THE USE OF CONFIGURATIONS

The configurations allow the identification of the satellites and the determination of their position in tangential equatorial coordinates referred to the planet Saturn with the precision as follow (for a lecture on the curves with an accuracy of 0.5 millimeter) :

| | | | |
|-----|------------|------|-----------|
| I | : 2 to 10" | V | : 2 to 3" |
| II | : 2 to 8" | VI | : 2 to 3" |
| III | : 2 to 6" | VII | : 2 to 3" |
| IV | : 2 to 4" | VIII | : 2 to 3" |

This example shows how to proceed :

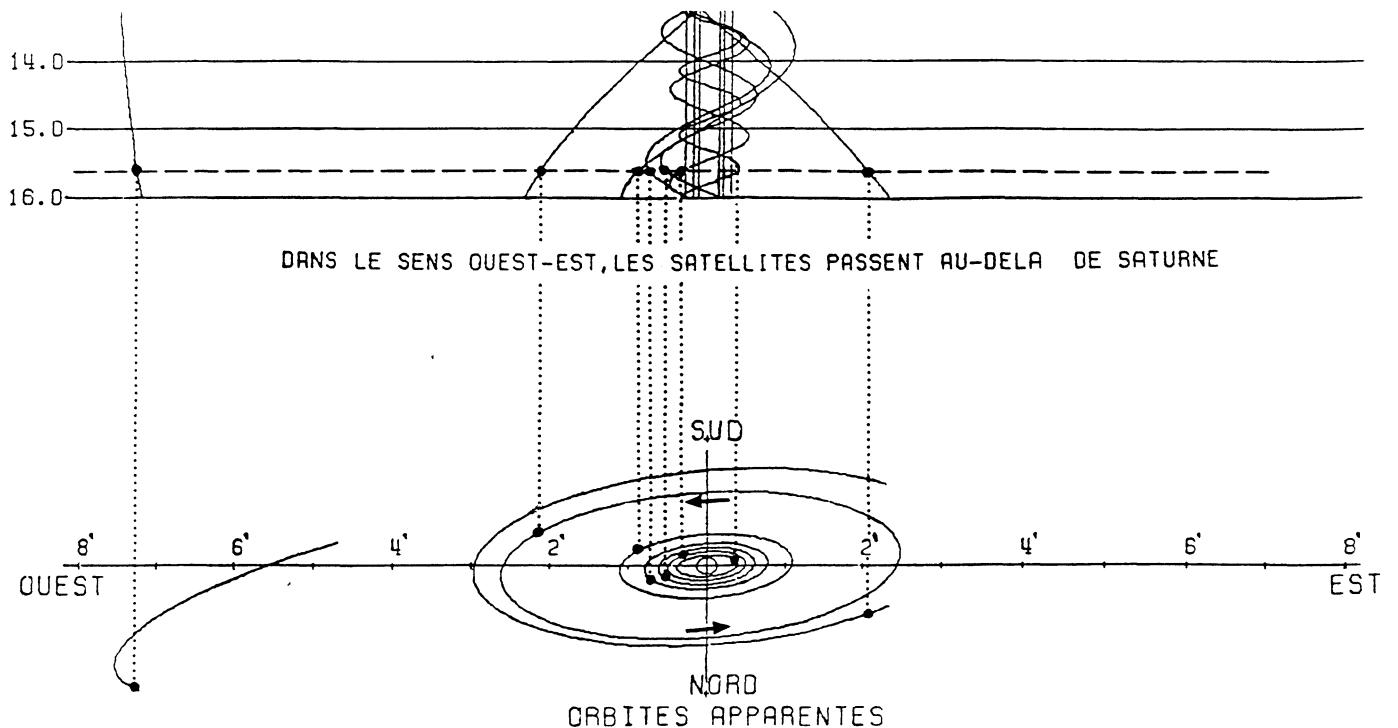

The distances $\Delta\alpha \cos \delta$, measured on the curves for the chosen date, are plotted in abscissa on west-east axis. The ordinate is given by the apparent orbits. The direction of the rotation indicates if the satellite is before or behind the planet on its orbit.

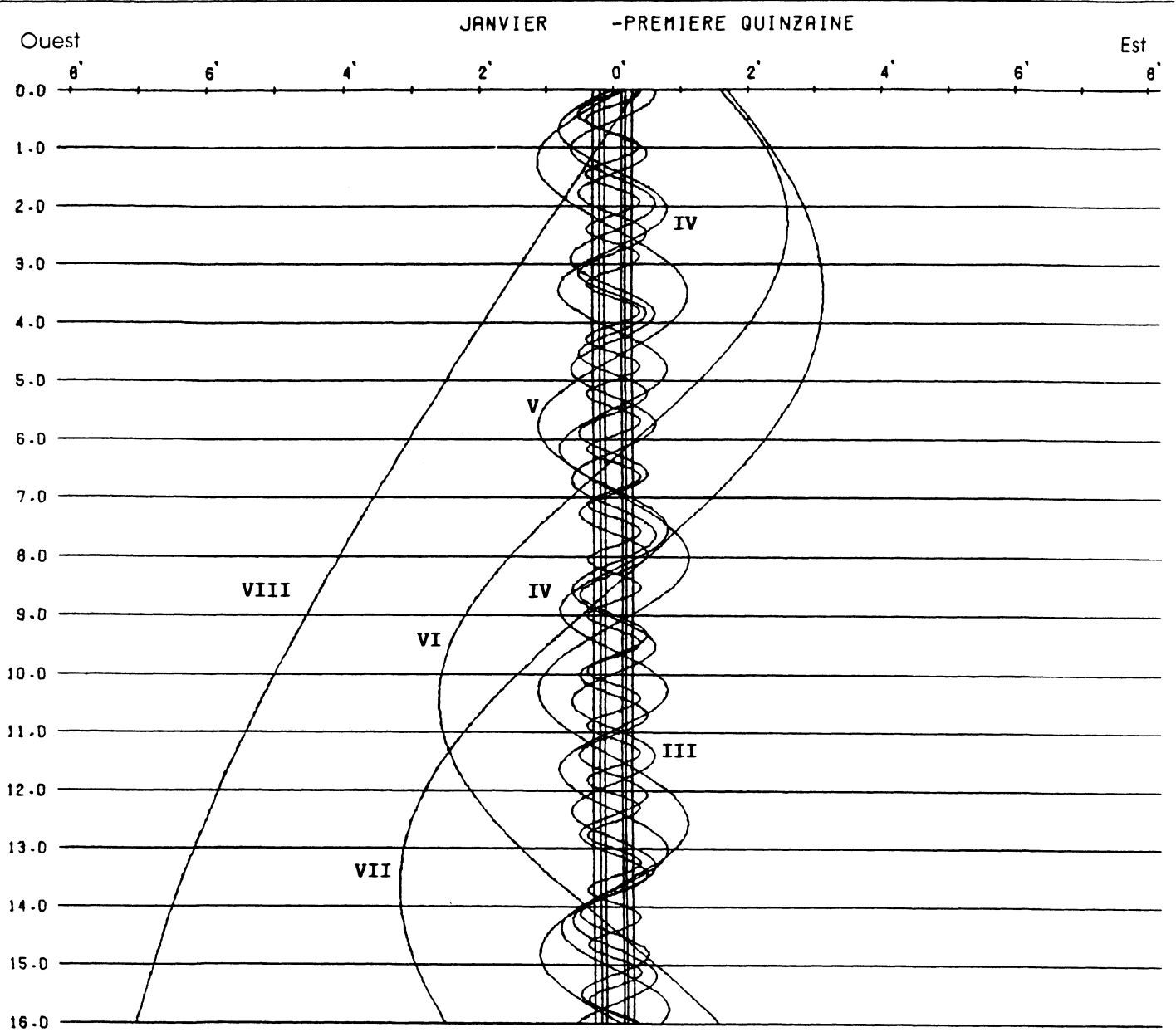

DANS LE SENS OUEST-EST. LES SATELLITES PASSENT AU-DELA DE SATURNE

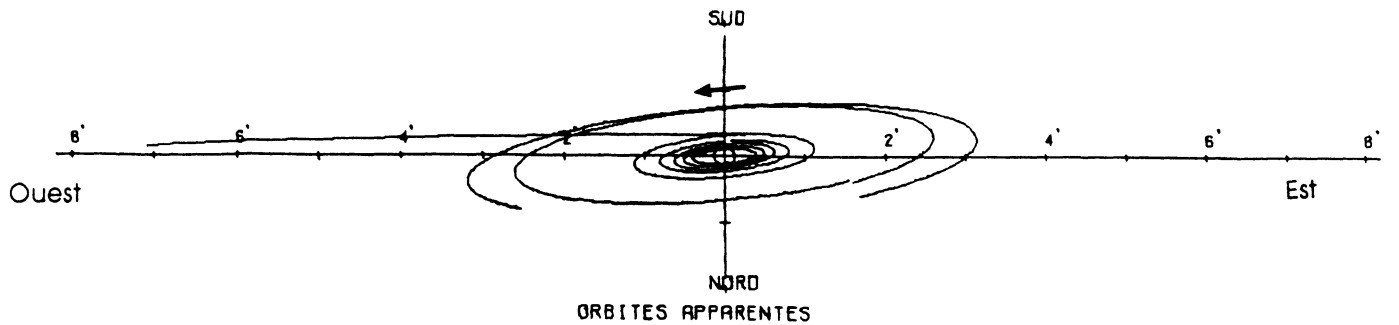

1993 .-CONFIGURATIONS DES SATELLITES DE SATURNE

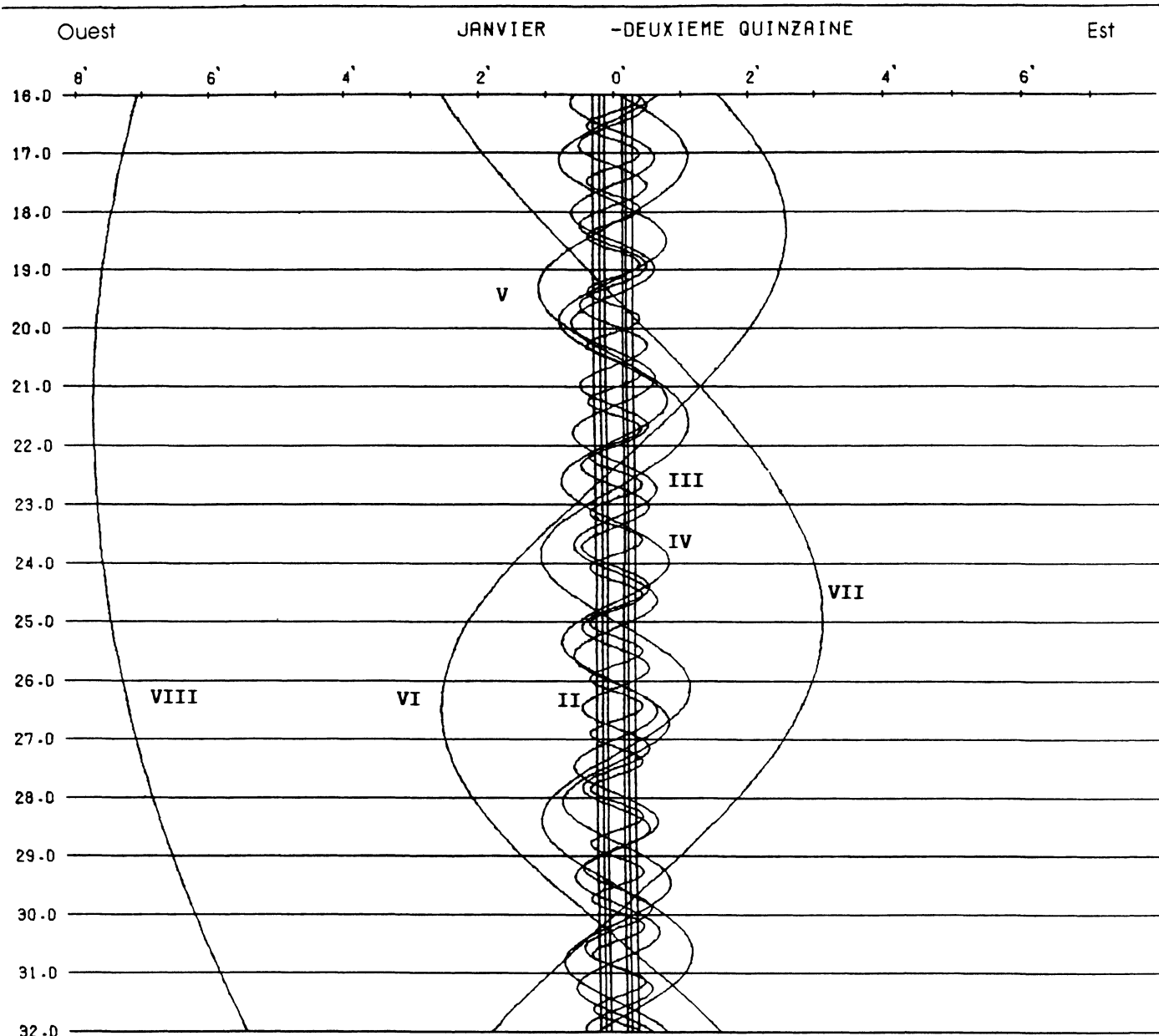

DANS LE SENS OUEST-EST. LES SATELLITES PASSENT AU-DELA DE SATURNE

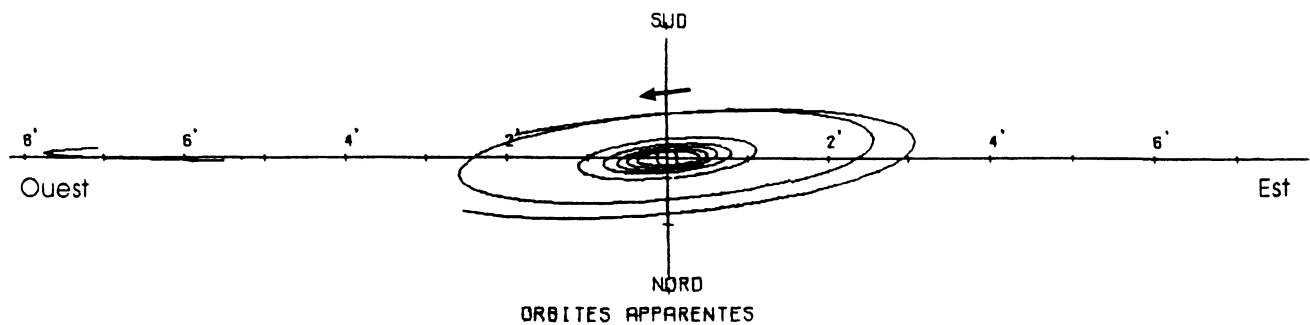

1993 .-CONFIGURATIONS DES SATELLITES DE SATURNE

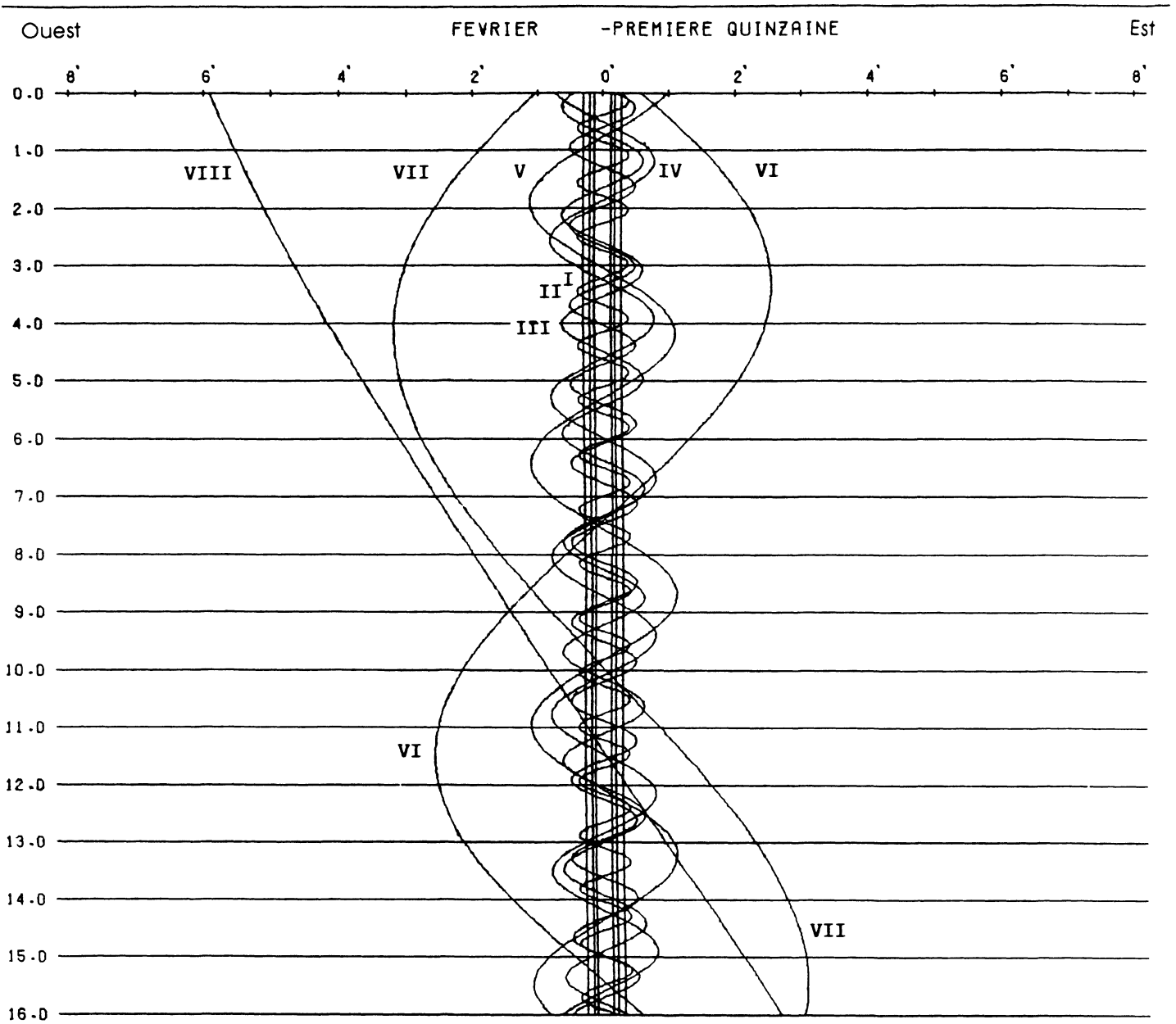

DANS LE SENS OUEST-EST, LES SATELLITES PASSENT AU-DELA DE SATURNE

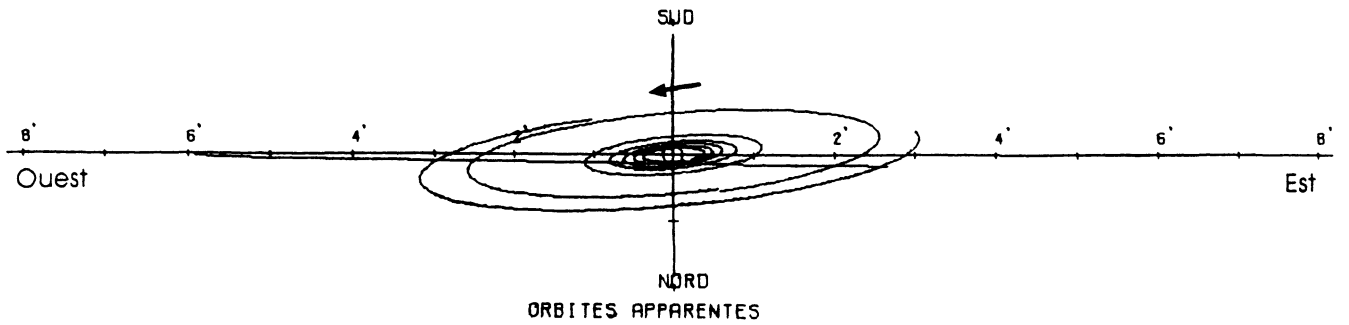

1993 .-CONFIGURATIONS DES SATELLITES DE SATURNE

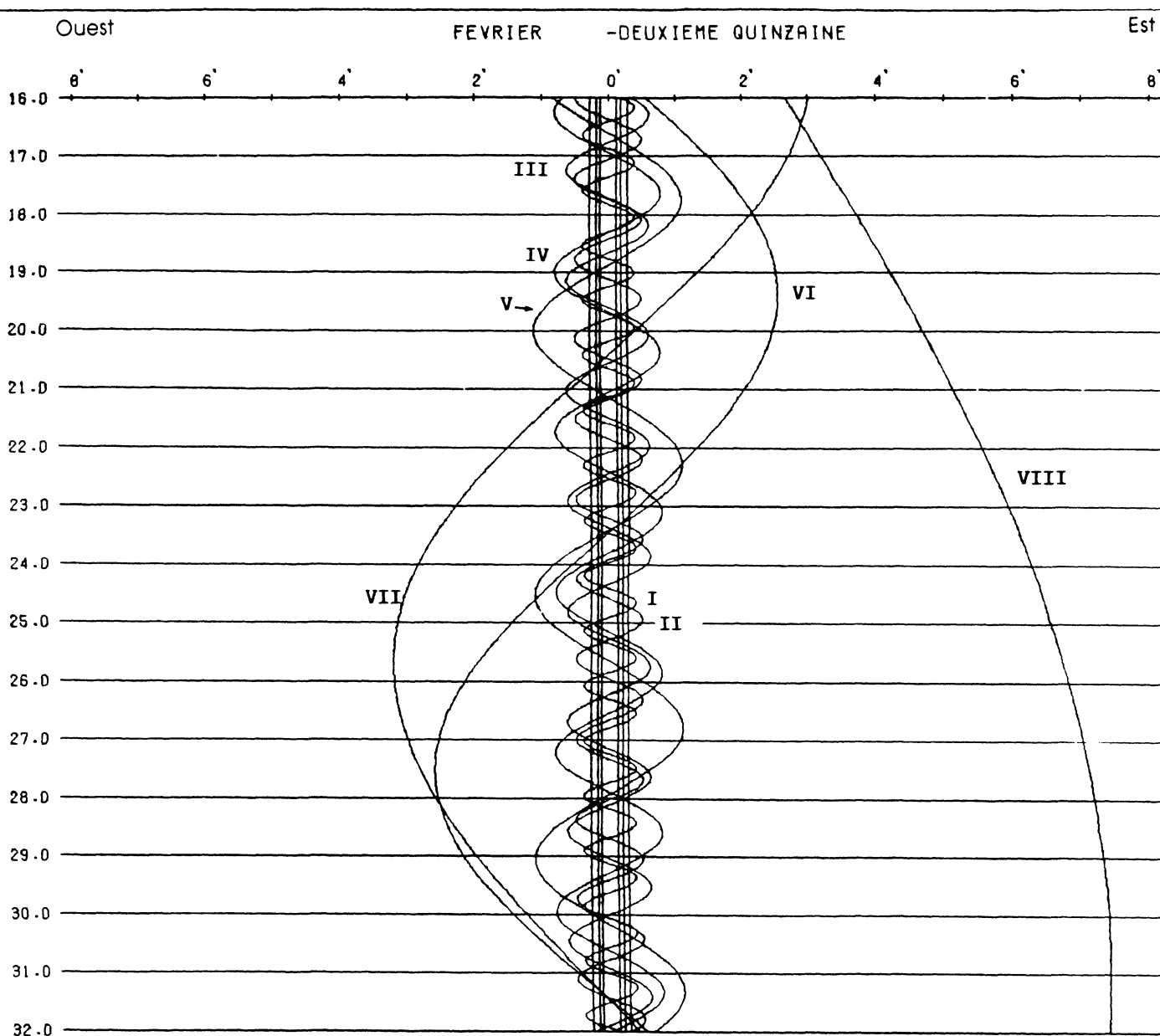

DANS LE SENS OUEST-EST, LES SATELLITES PASSENT AU-DELA DE SATURNE

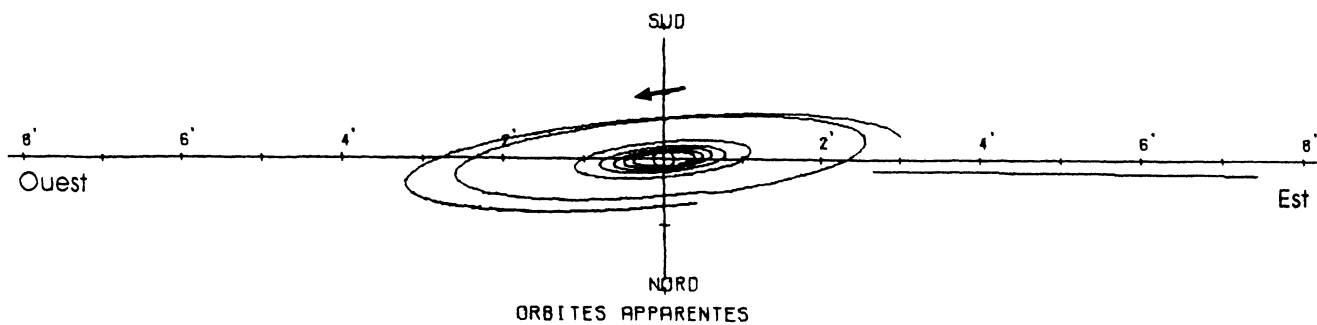

1993 .-CONFIGURATIONS DES SATELLITES DE SATURNE

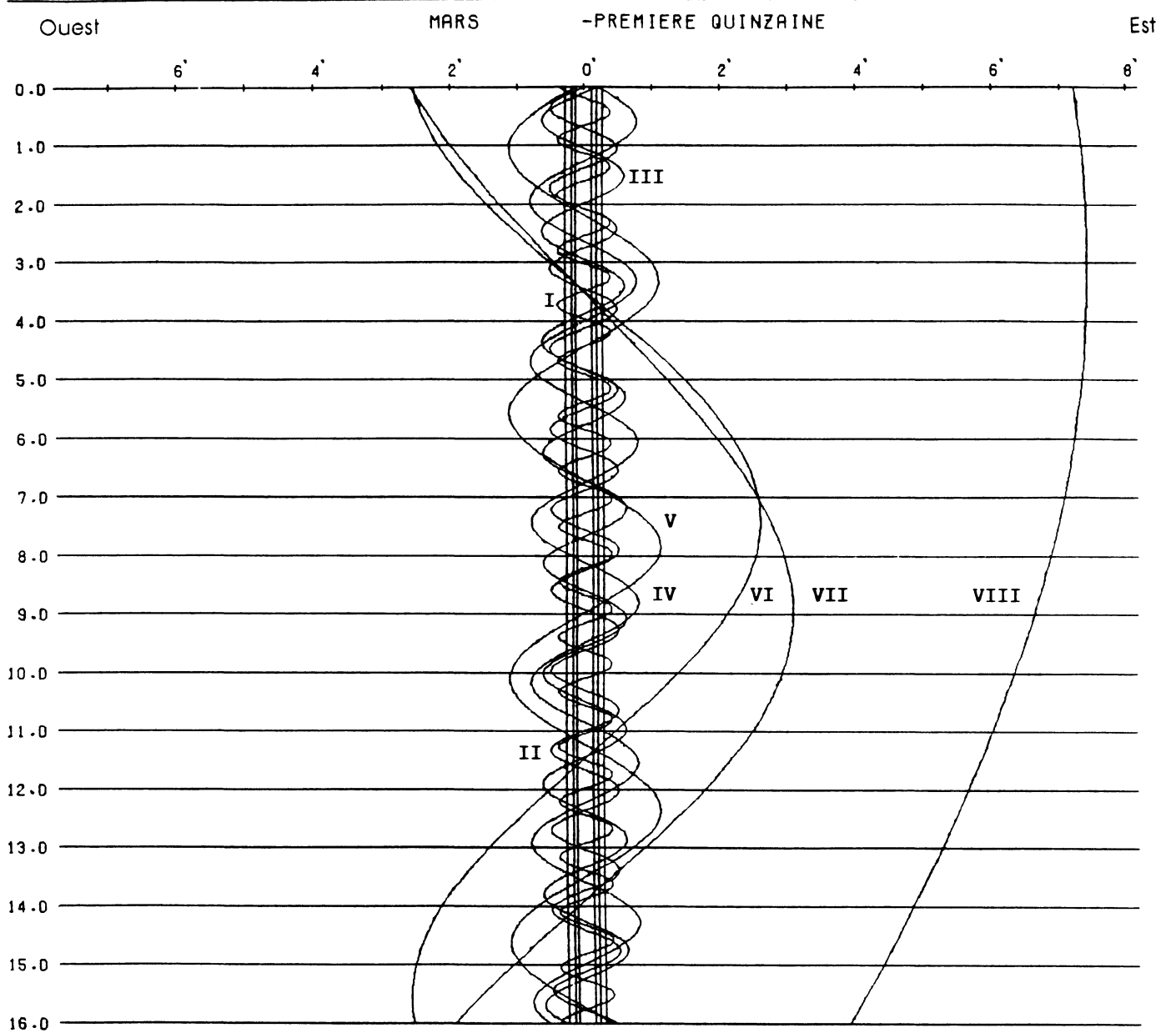

DANS LE SENS OUEST-EST. LES SATELLITES PASSENT AU-DELA DE SATURNE

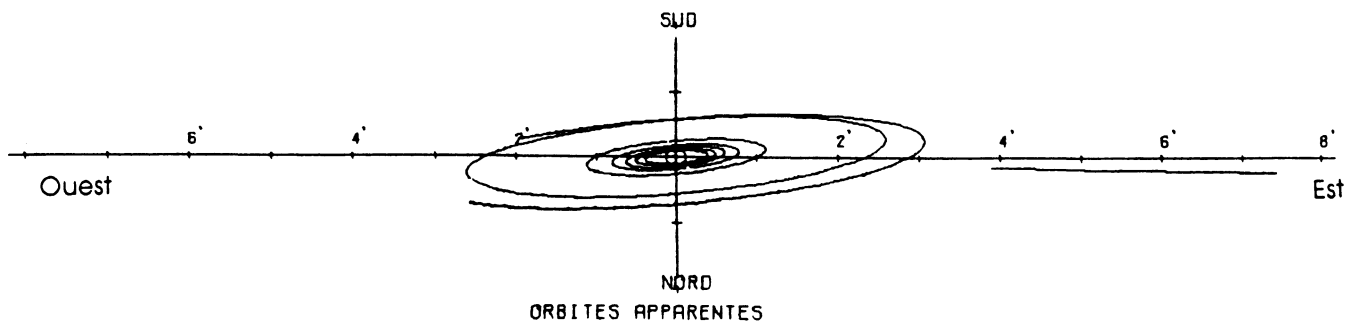

1993 .-CONFIGURATIONS DES SATELLITES DE SATURNE

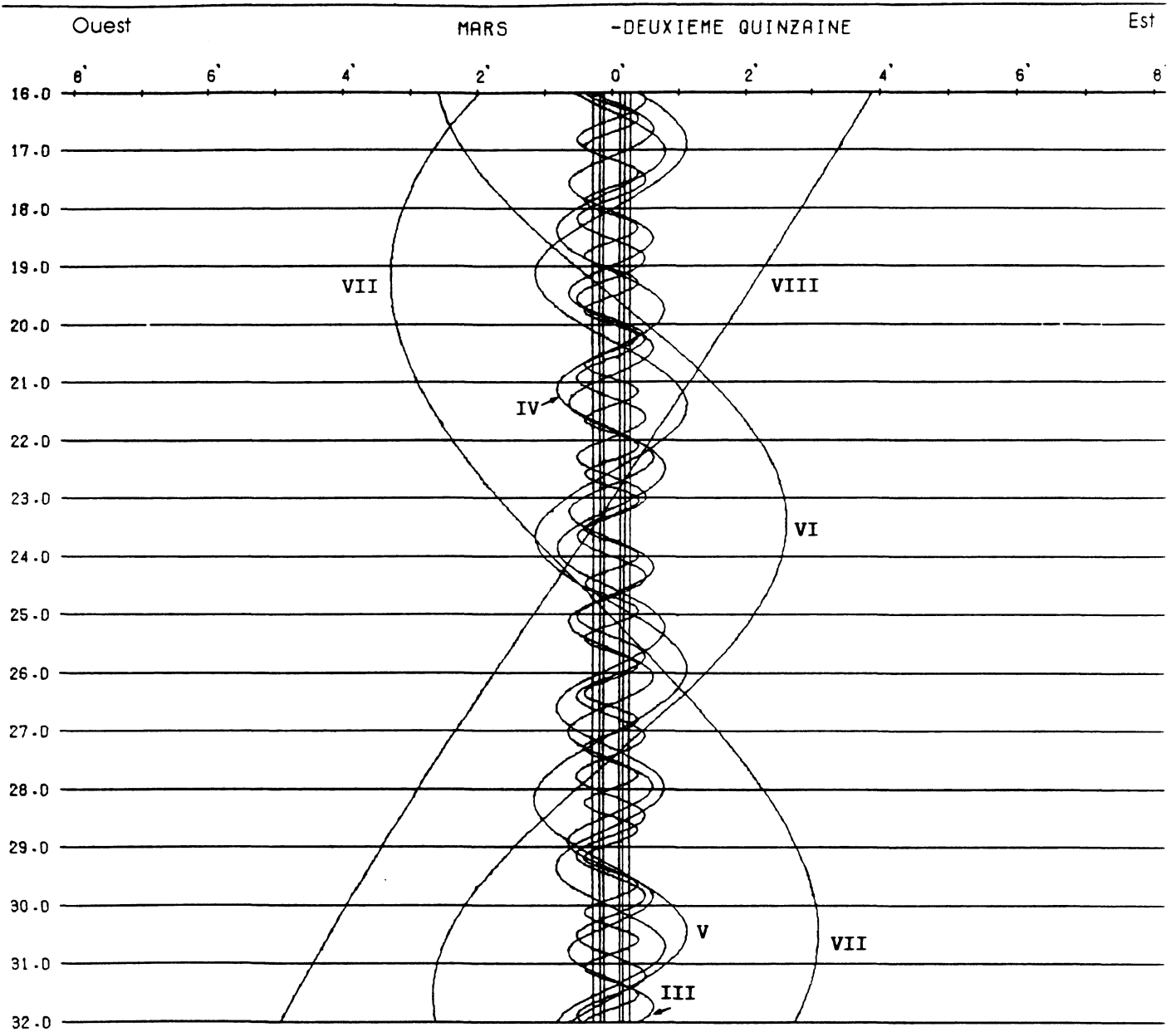

DANS LE SENS OUEST-EST. LES SATELLITES PASSENT AU-DELA DE SATURNE

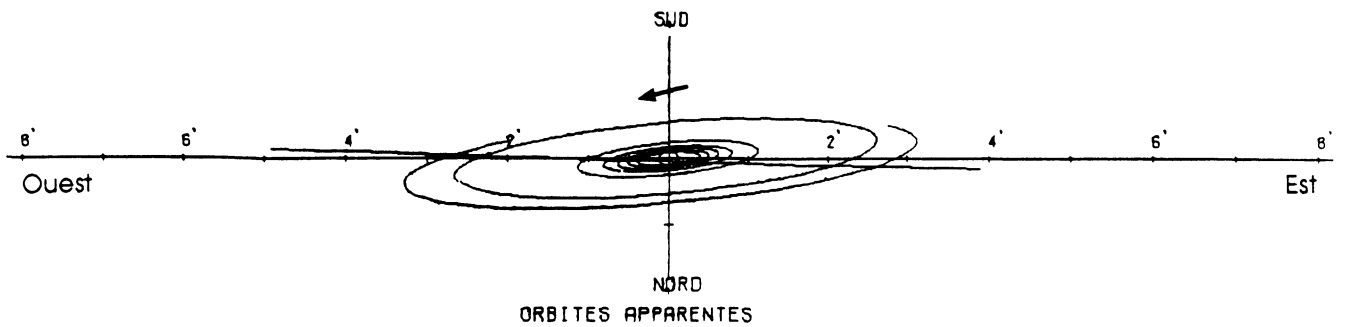

1993 .--CONFIGURATIONS DES SATELLITES DE SATURNE

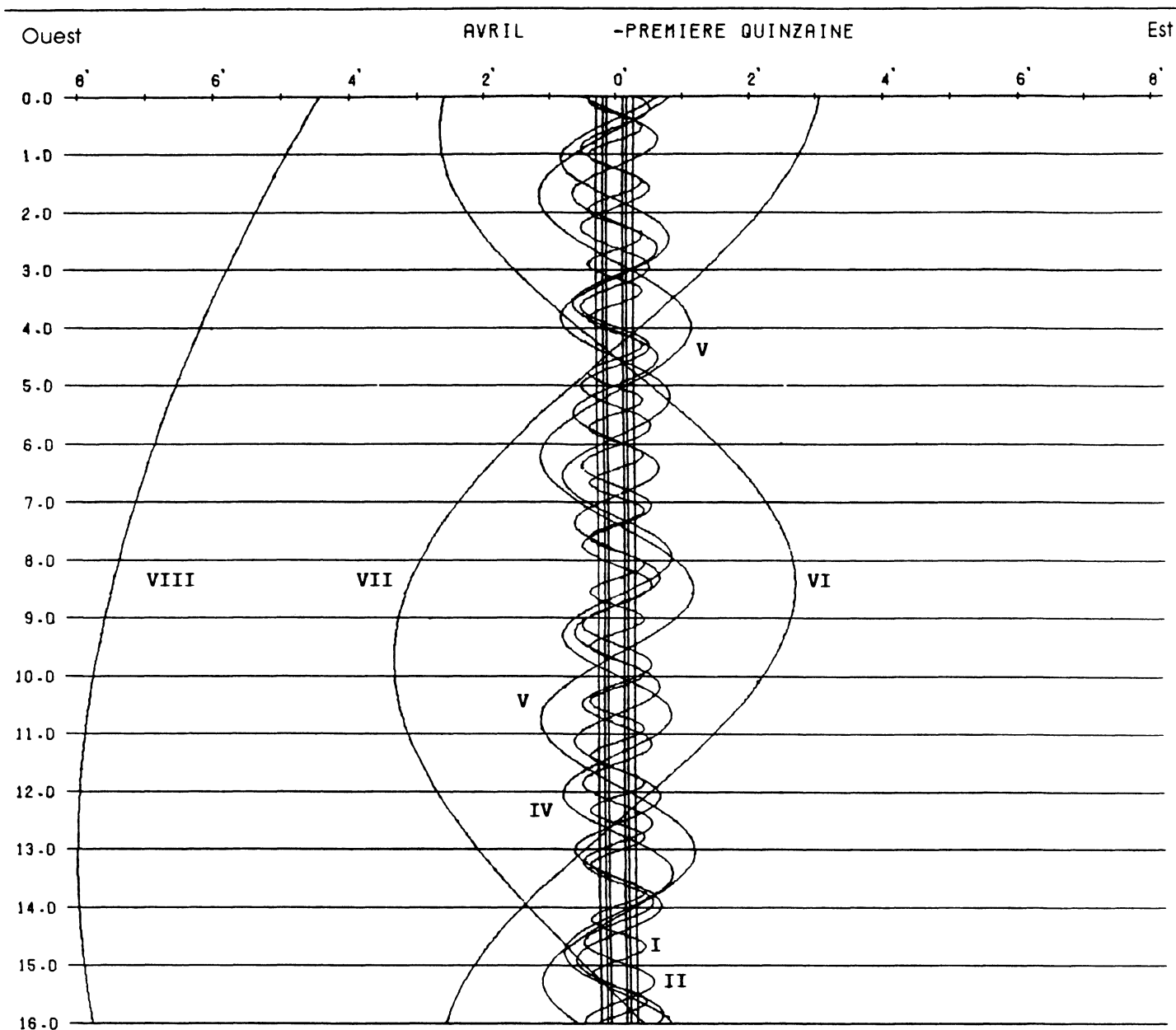

DANS LE SENS OUEST-EST, LES SATELLITES PASSENT AU-DELA DE SATURNE

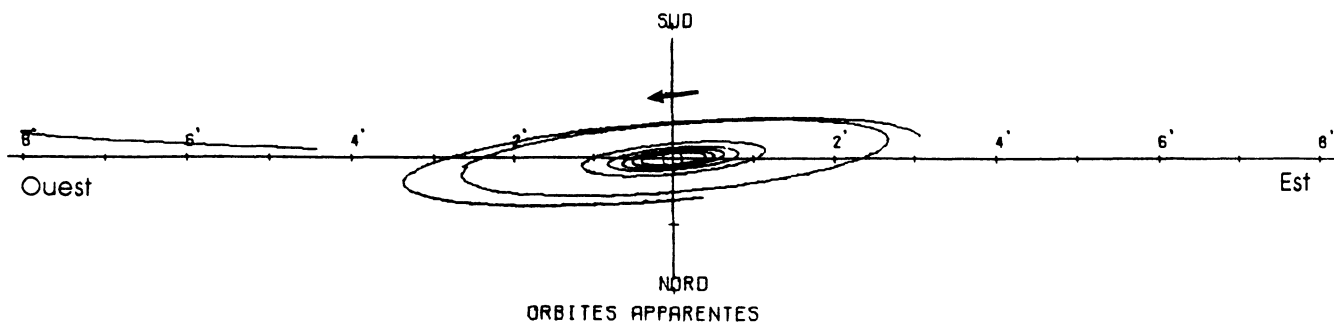

1993 .-CONFIGURATIONS DES SATELLITES DE SATURNE

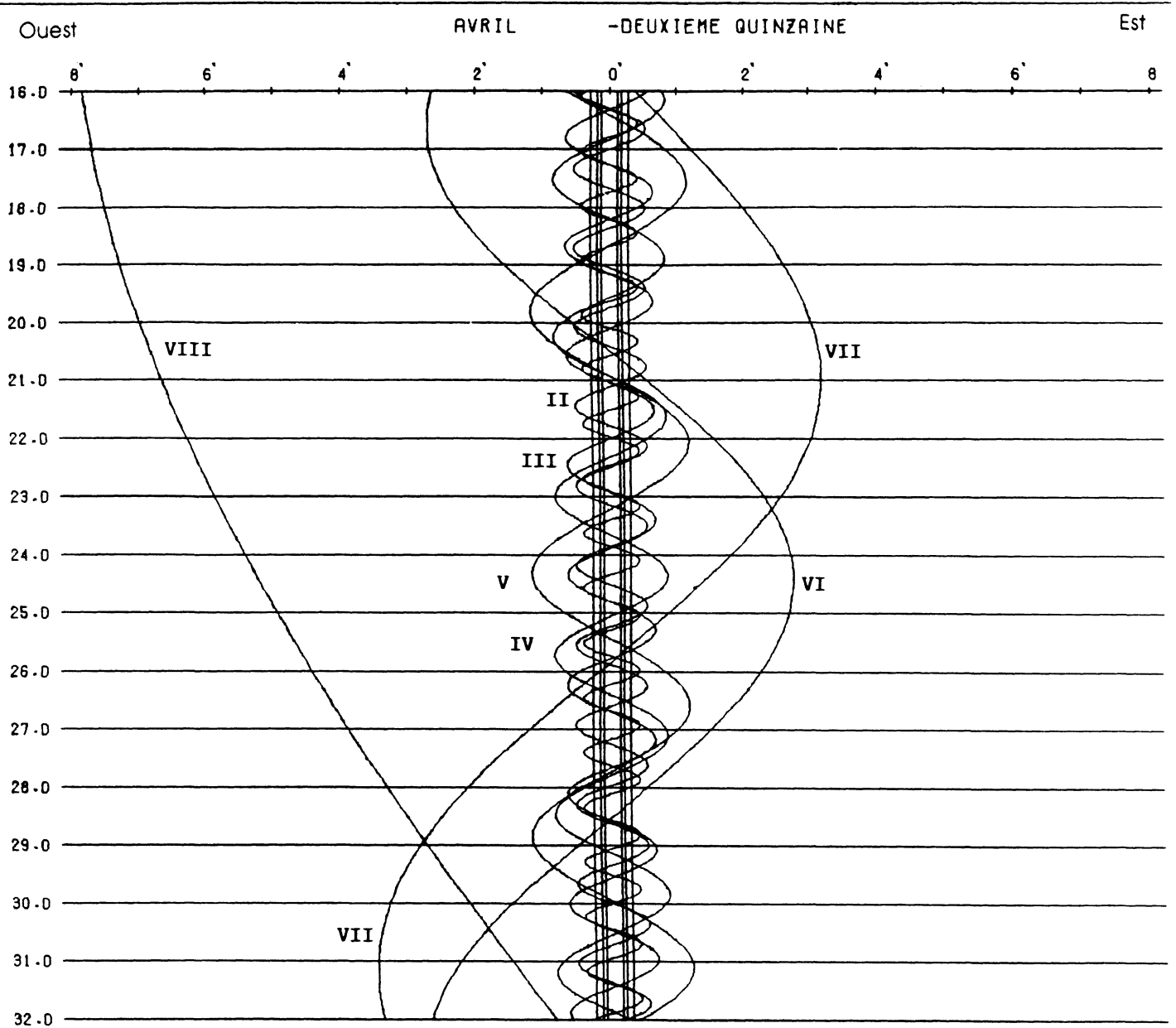

DANS LE SENS OUEST-EST. LES SATELLITES PASSENT AU-DELA DE SATURNE

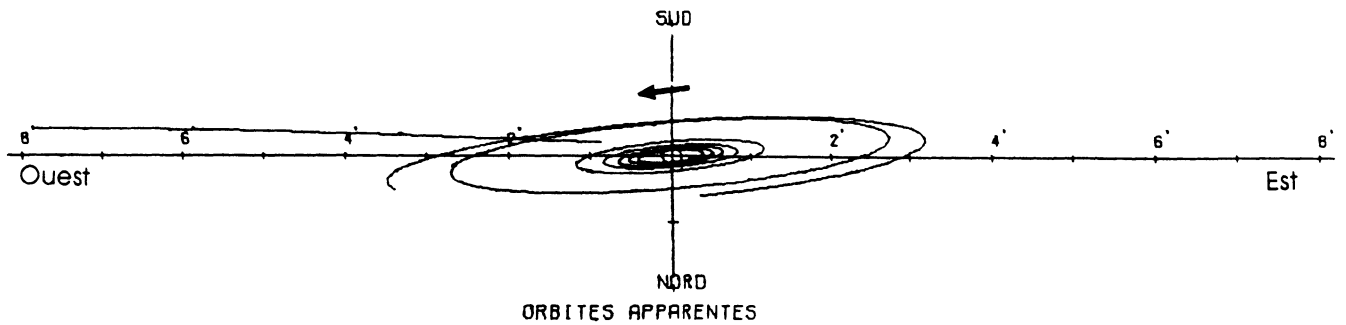

1993 .-CONFIGURATIONS DES SATELLITES DE SATURNE

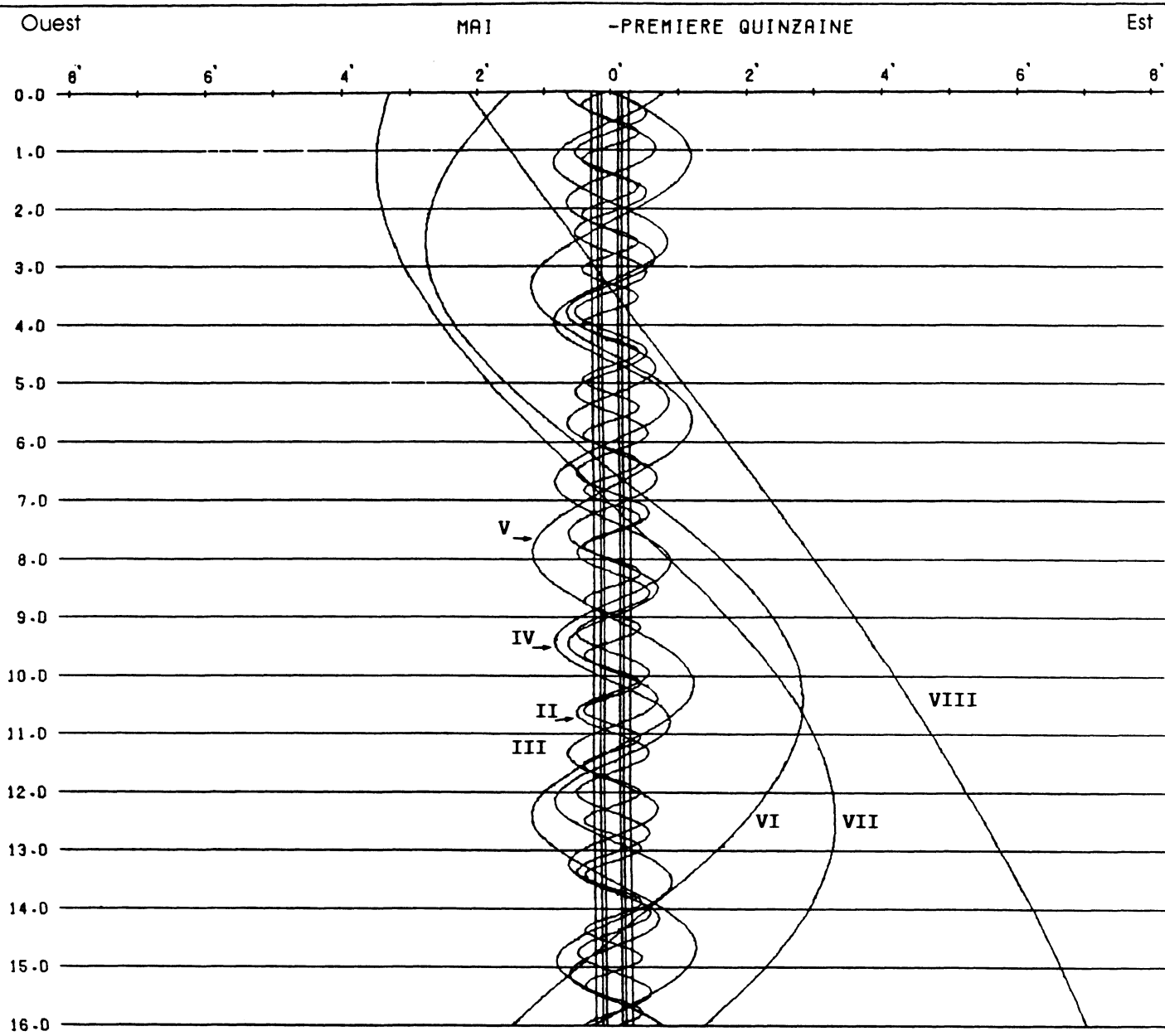

DANS LE SENS OUEST-EST, LES SATELLITES PASSENT AU-DELA DE SATURNE

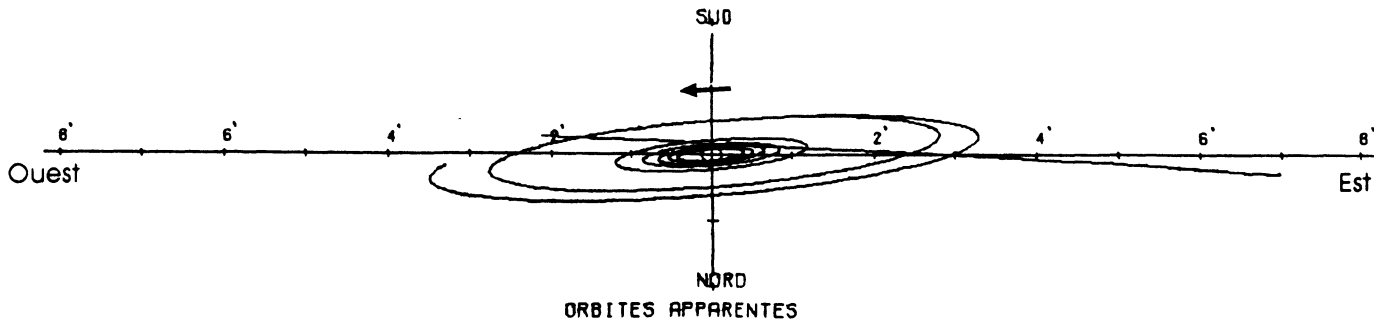

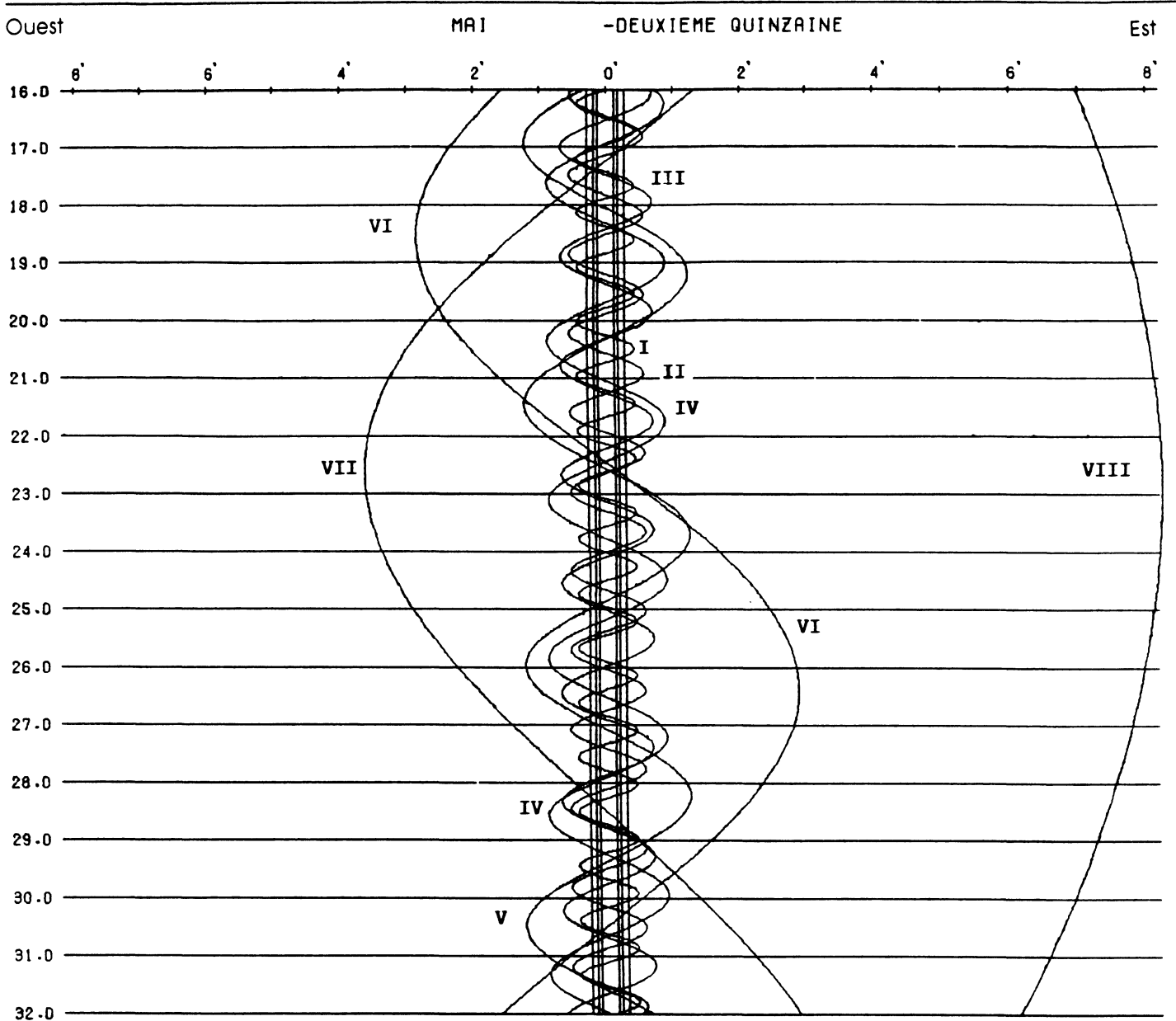

DANS LE SENS OUEST-EST, LES SATELLITES PASSENT AU-DELA DE SATURNE

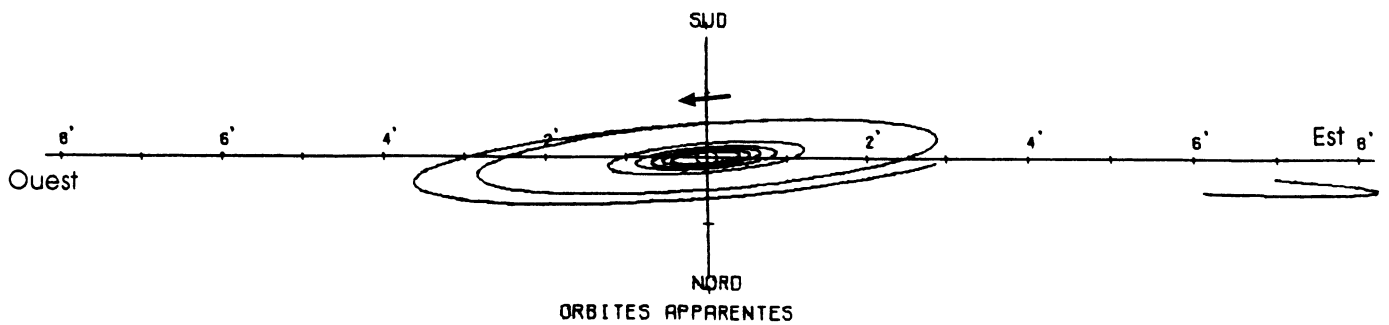

1993 .--CONFIGURATIONS DES SATELLITES DE SATURNE

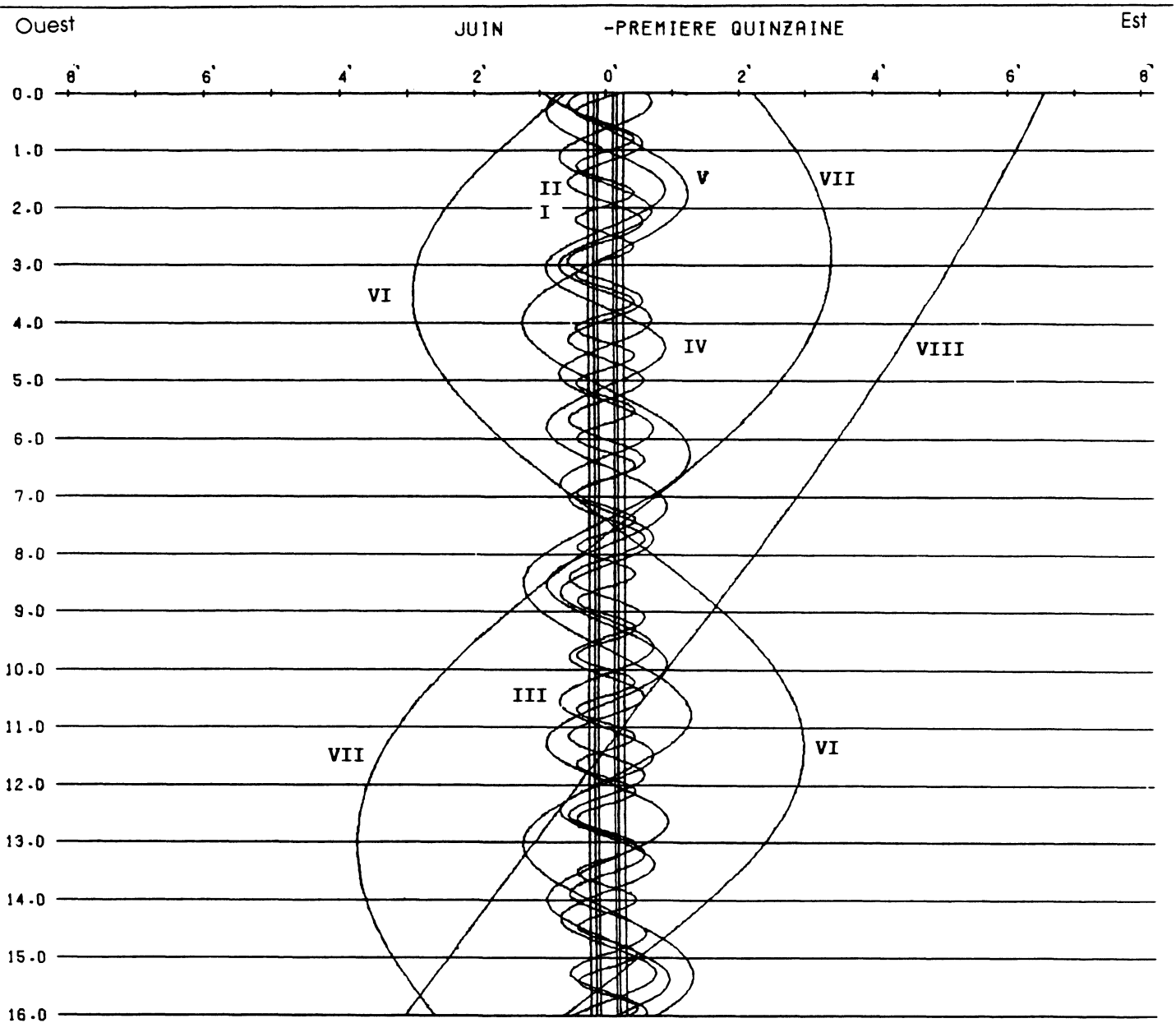

DANS LE SENS OUEST-EST. LES SATELLITES PASSES AU-DELA DE SATURNE

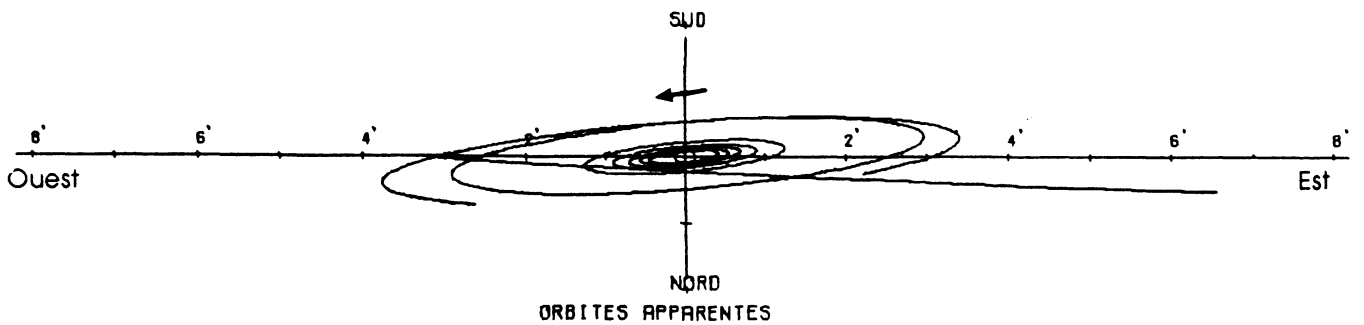

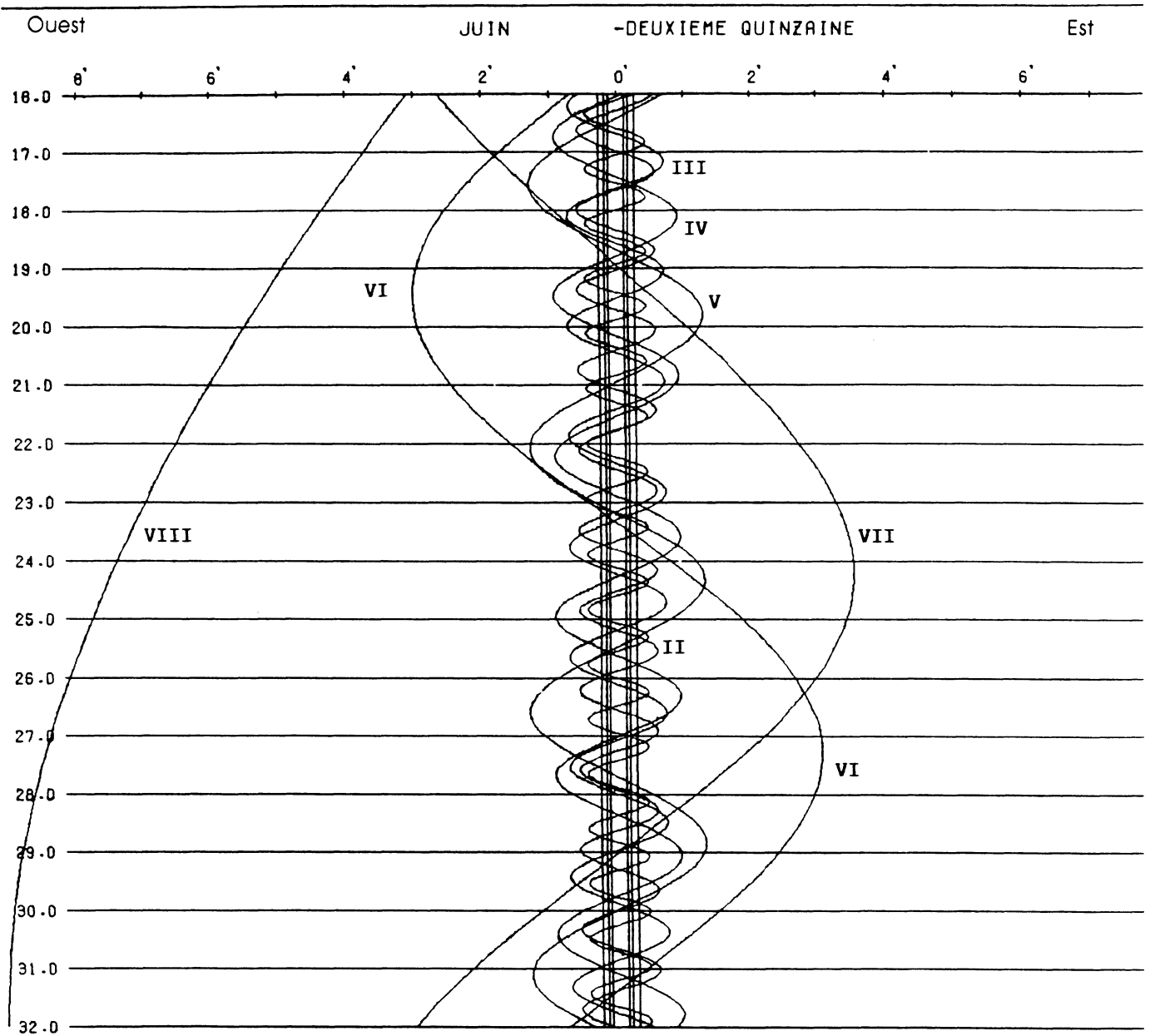

DANS LE SENS OUEST-EST, LES SATELLITES PASSES AU-DELA DE SATURNE

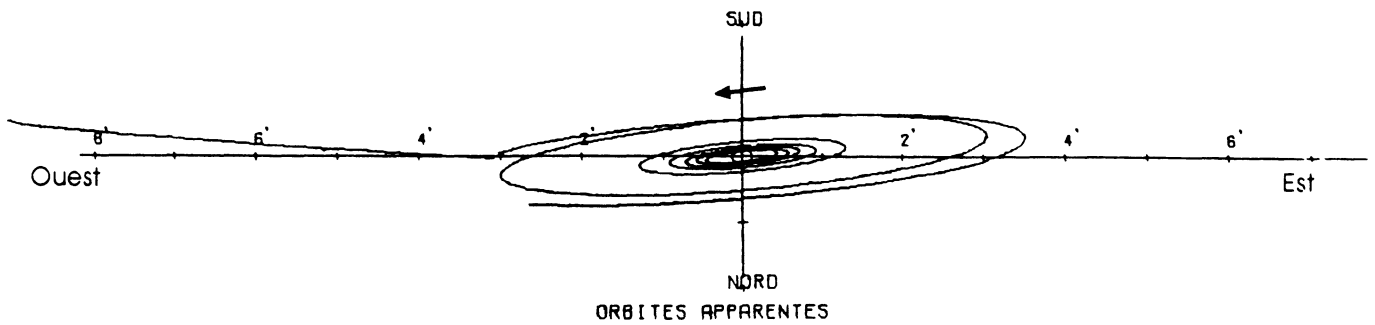

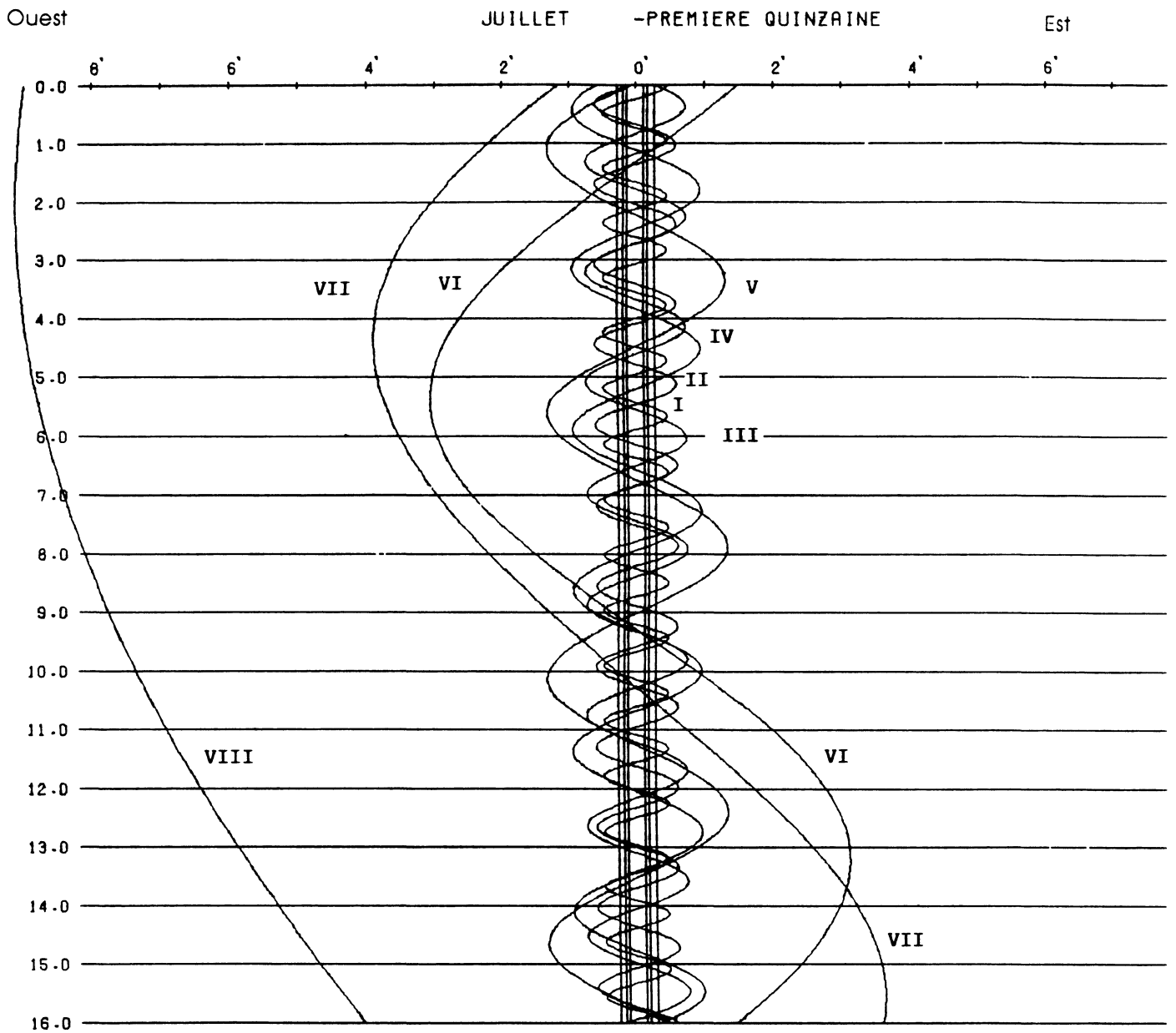

DANS LE SENS OUEST-EST, LES SATELLITES PASSENT AU-DELA DE SATURNE

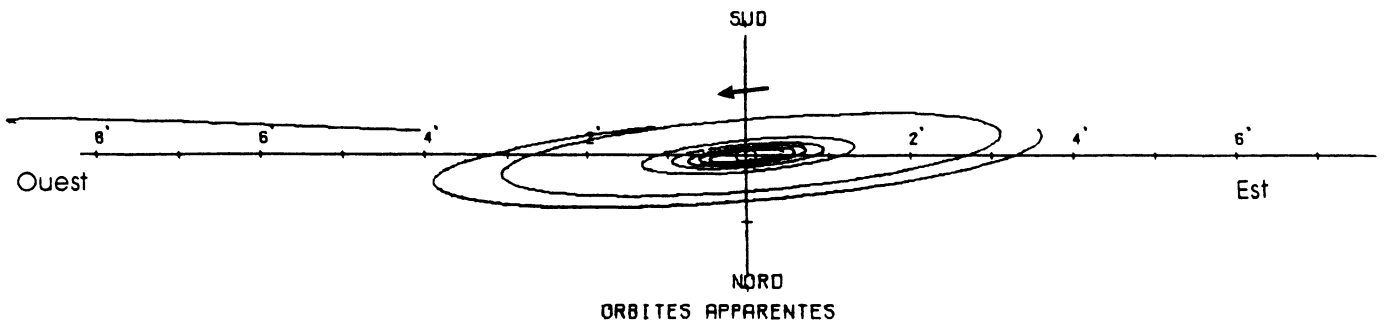

1993 .-CONFIGURATIONS DES SATELLITES DE SATURNE

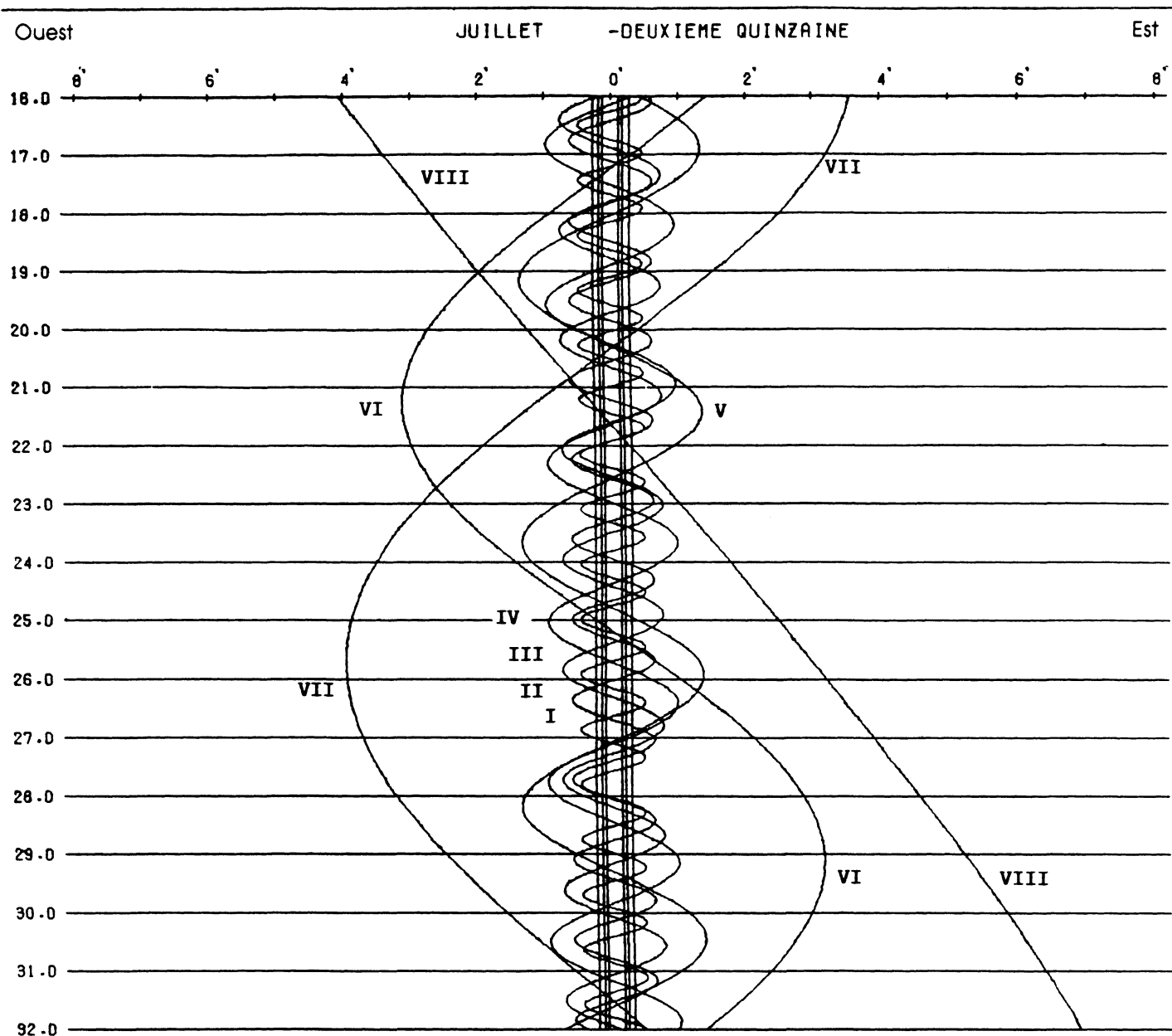

DANS LE SENS OUEST-EST, LES SATELLITES PASSENT AU-DELA DE SATURNE

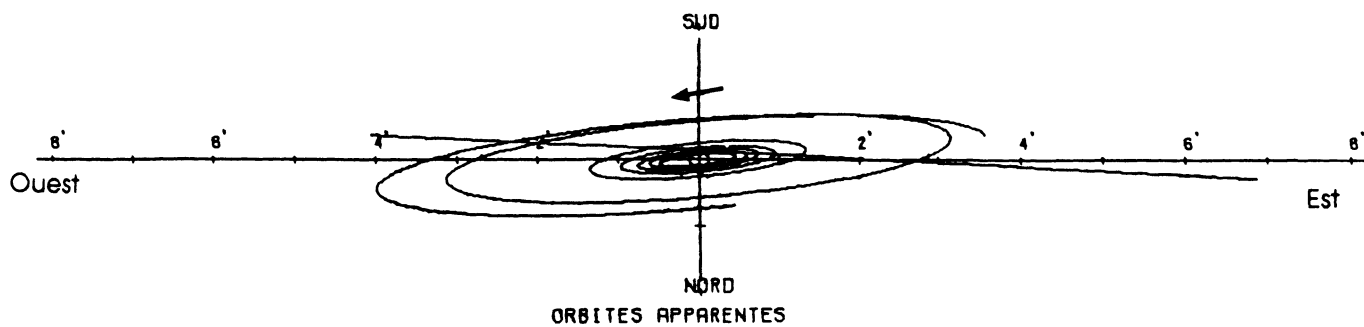

1993 .-CONFIGURATIONS DES SATELLITES DE SATURNE

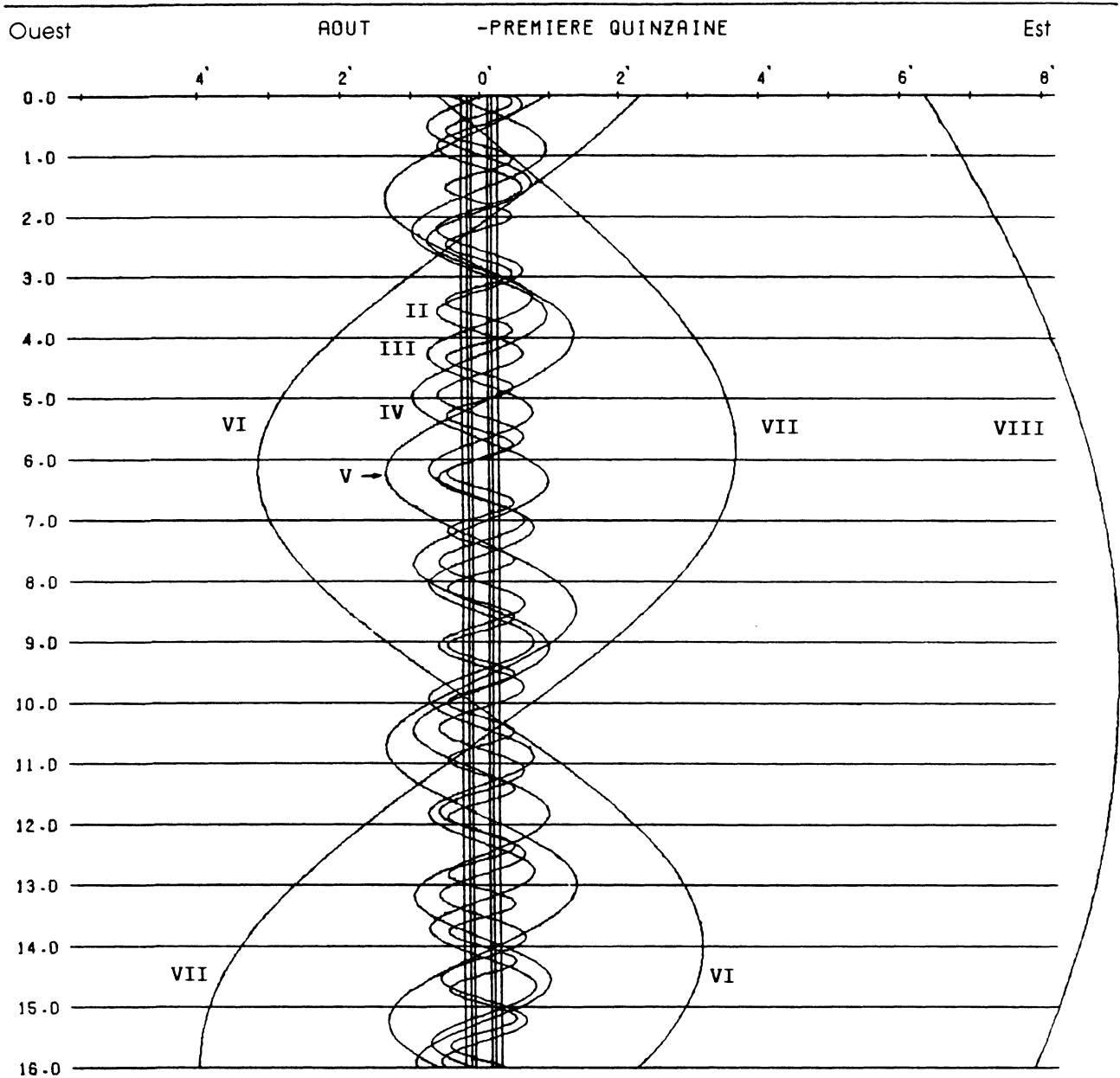

DANS LE SENS OUEST-EST.LES SATELLITES PASSENT AU-DELA DE SATURNE

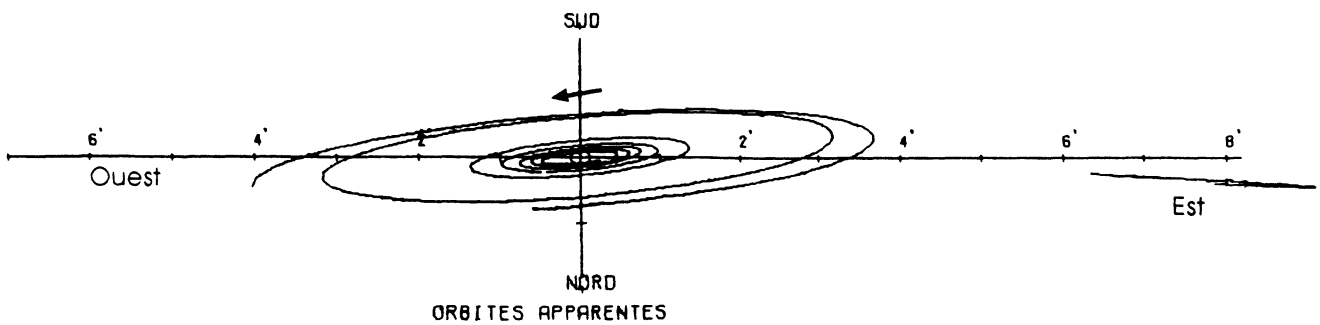

1993 .-CONFIGURATIONS DES SATELLITES DE SATURNE

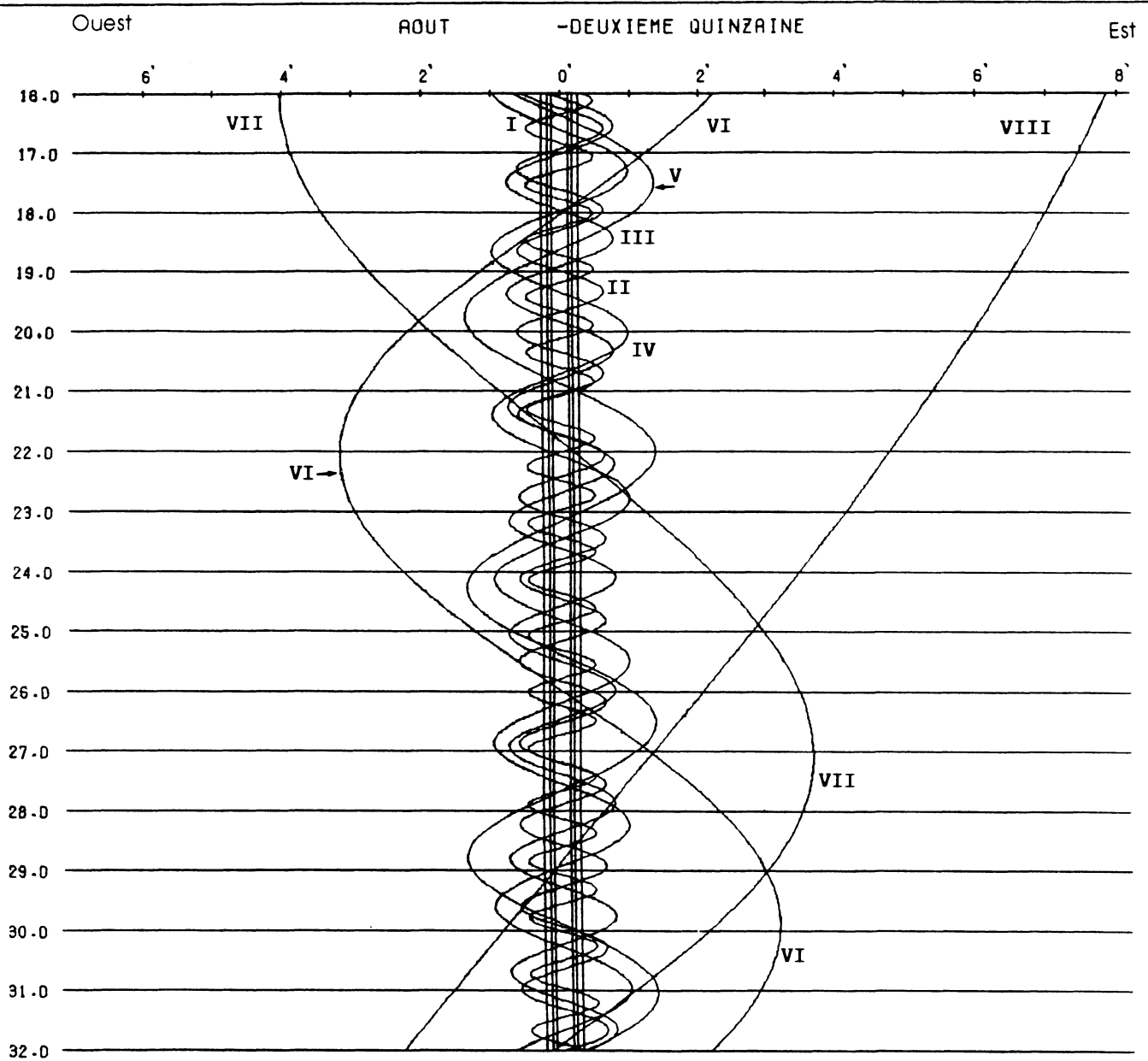

DANS LE SENS OUEST-EST.LES SATELLITES PASSENT AU-DELA DE SATURNE

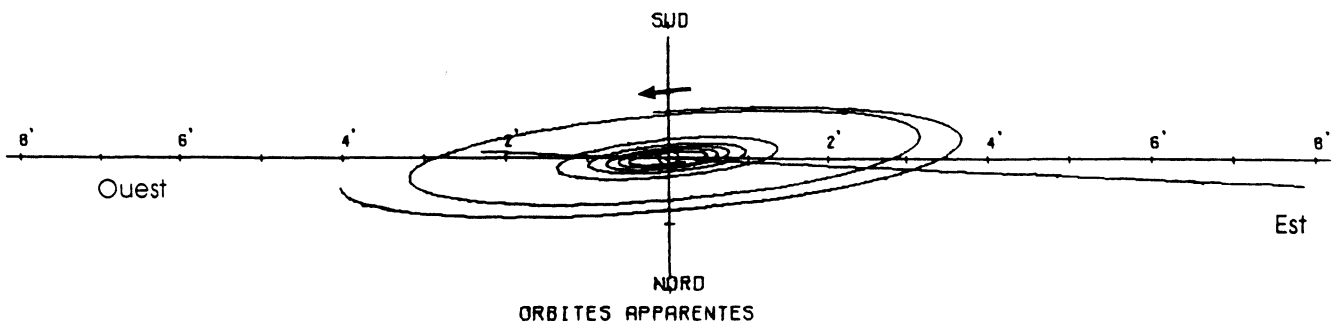

1993 .-CONFIGURATIONS DES SATELLITES DE SATURNE

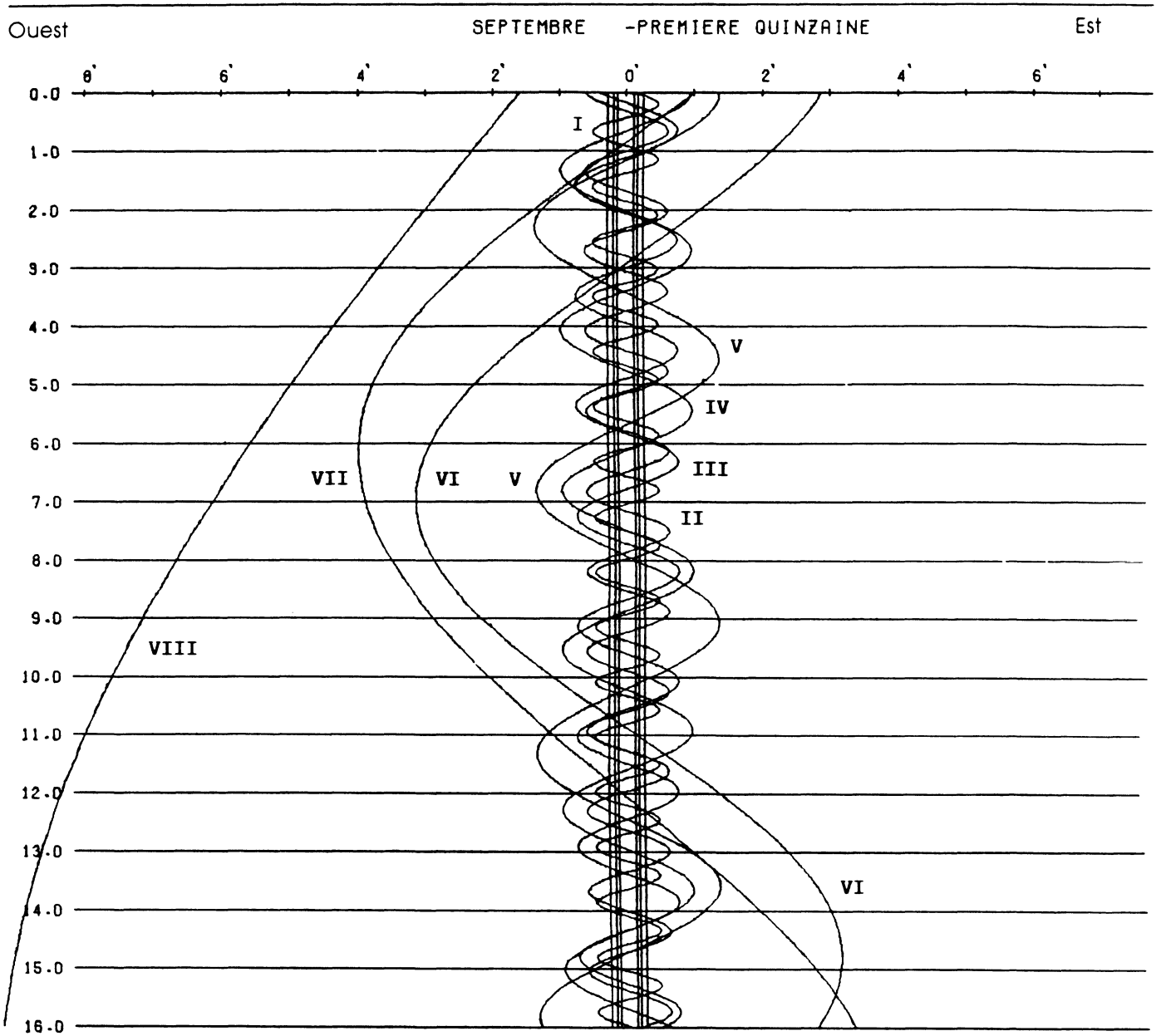

DANS LE SENS OUEST-EST. LES SATELLITES PASSENT AU-DELA DE SATURNE

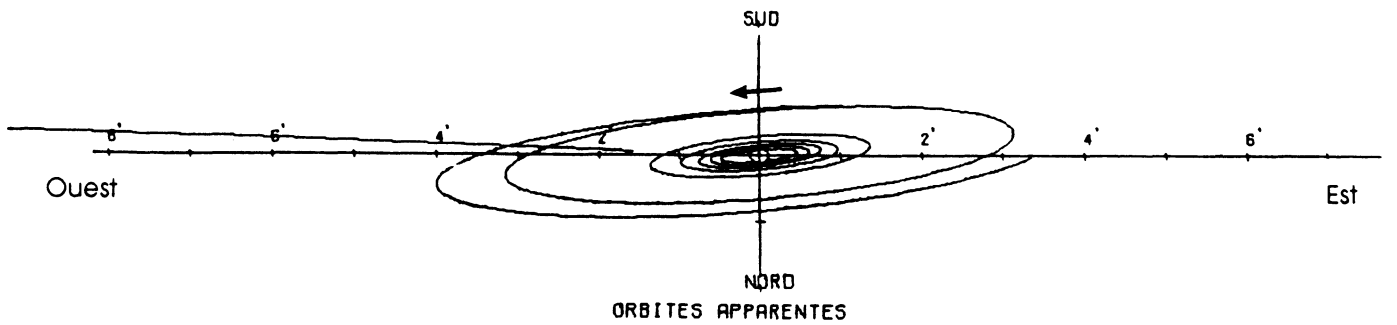

1993 .-CONFIGURATIONS DES SATELLITES DE SATURNE

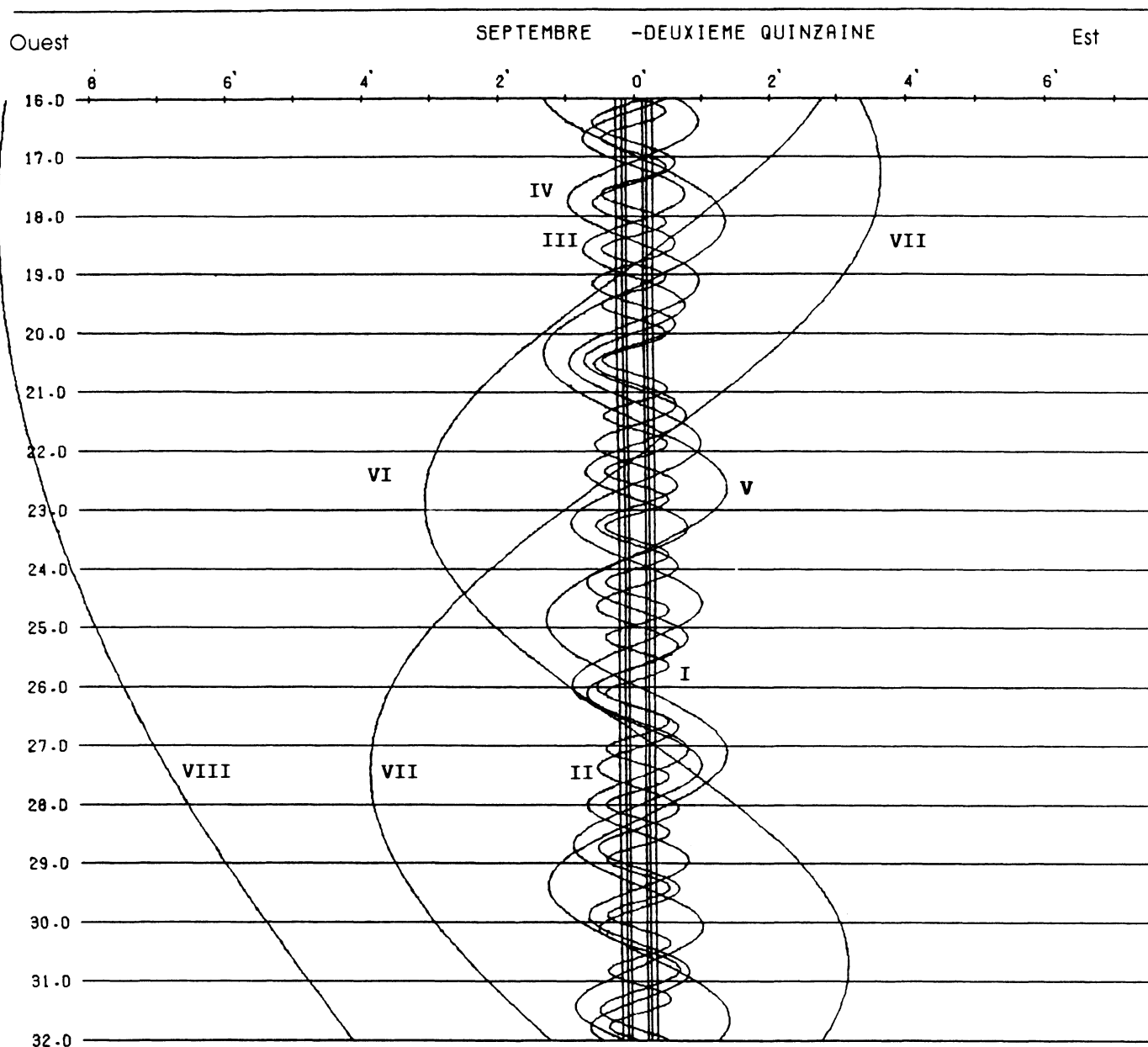

DANS LE SENS OUEST-EST, LES SATELLITES PASSENT AU-DELA DE SATURNE

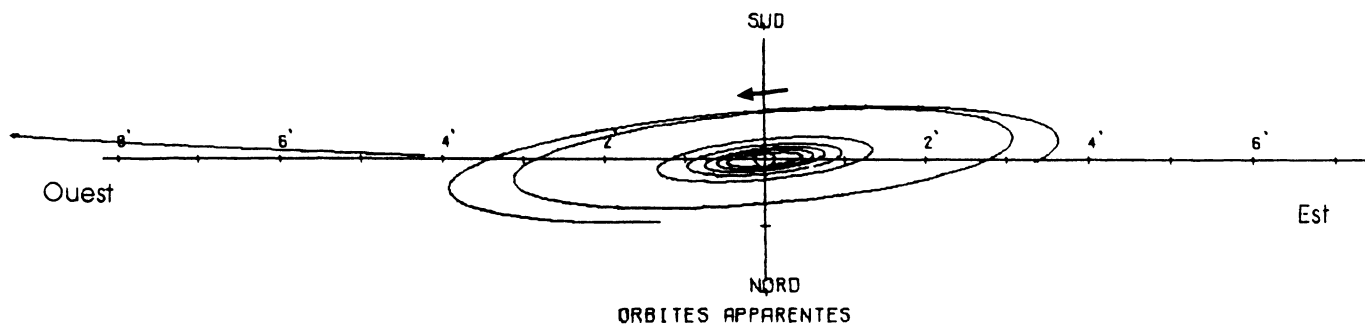

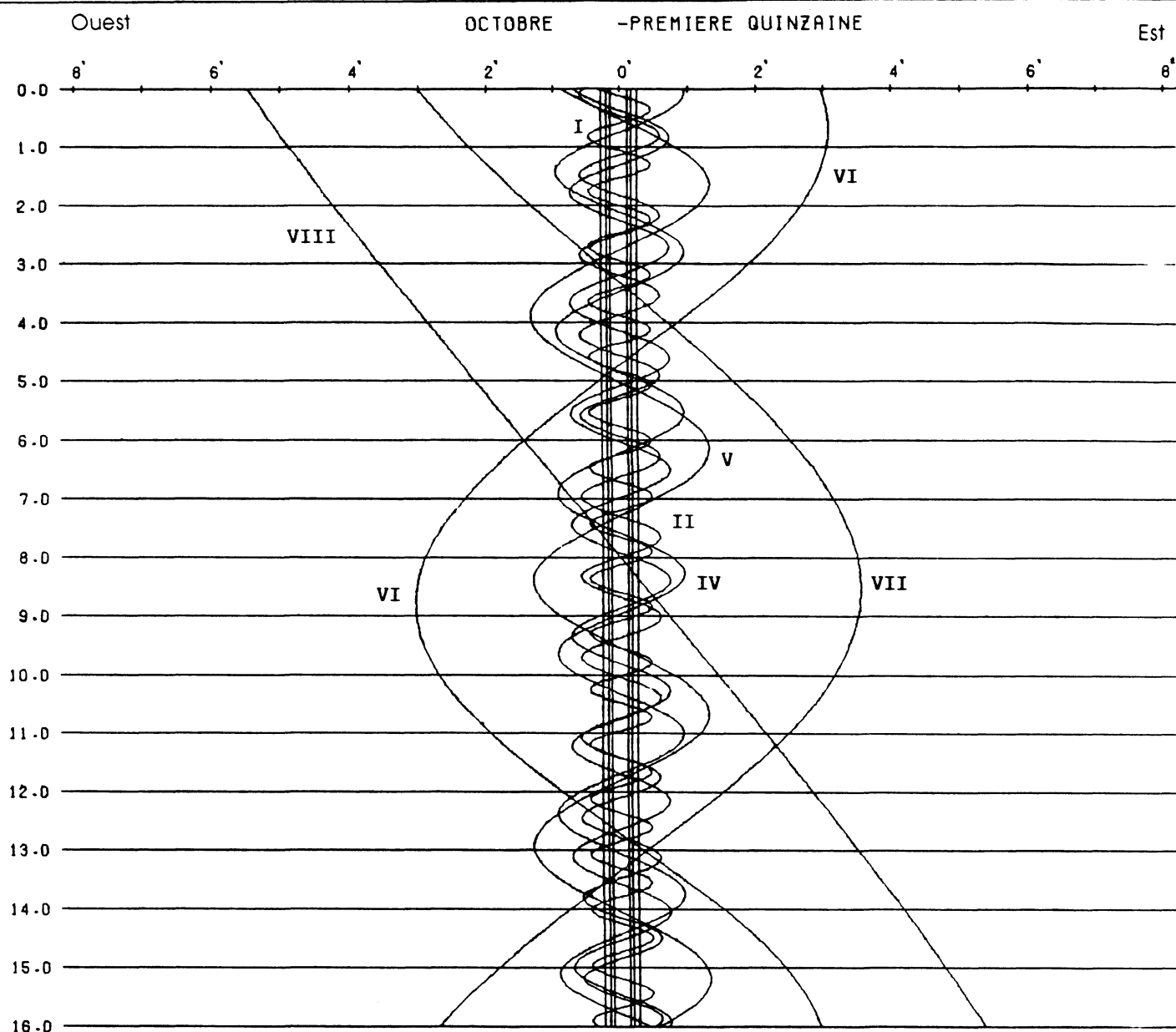

DANS LE SENS OUEST-EST. LES SATELLITES PASSENT AU-DELA DE SATURNE

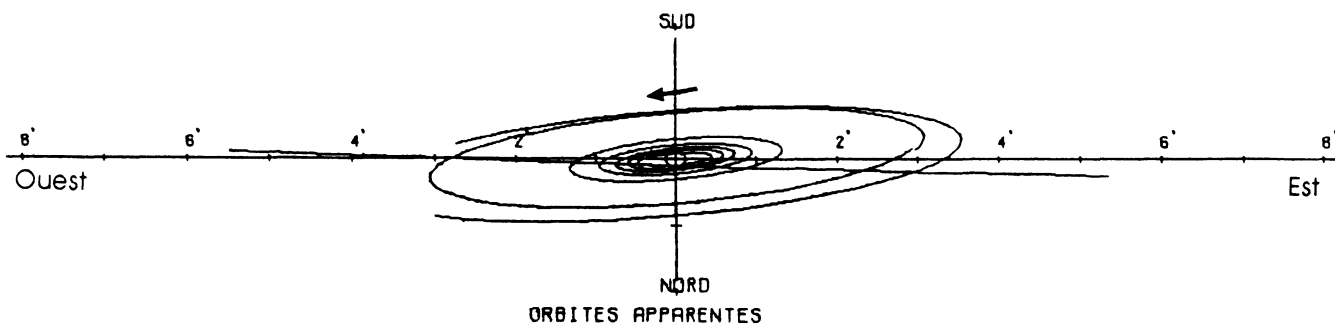

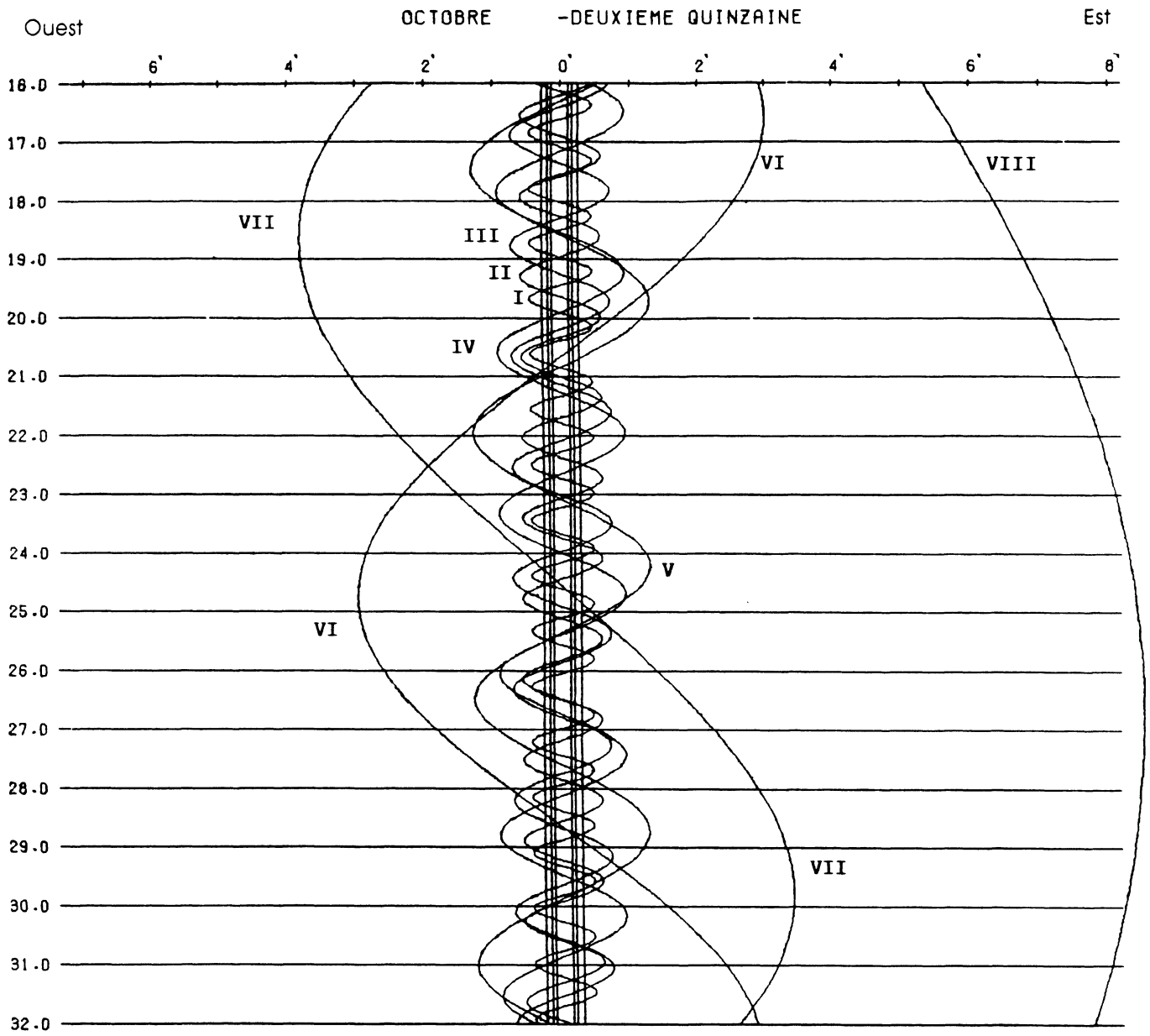

DANS LE SENS OUEST-EST, LES SATELLITES PASSENT AU-DELA DE SATURNE

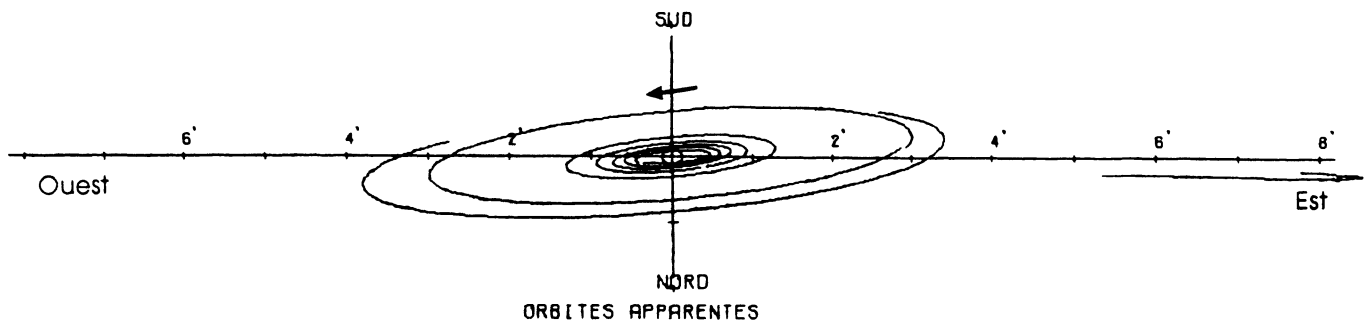

1993 .-CONFIGURATIONS DES SATELLITES DE SATURNE

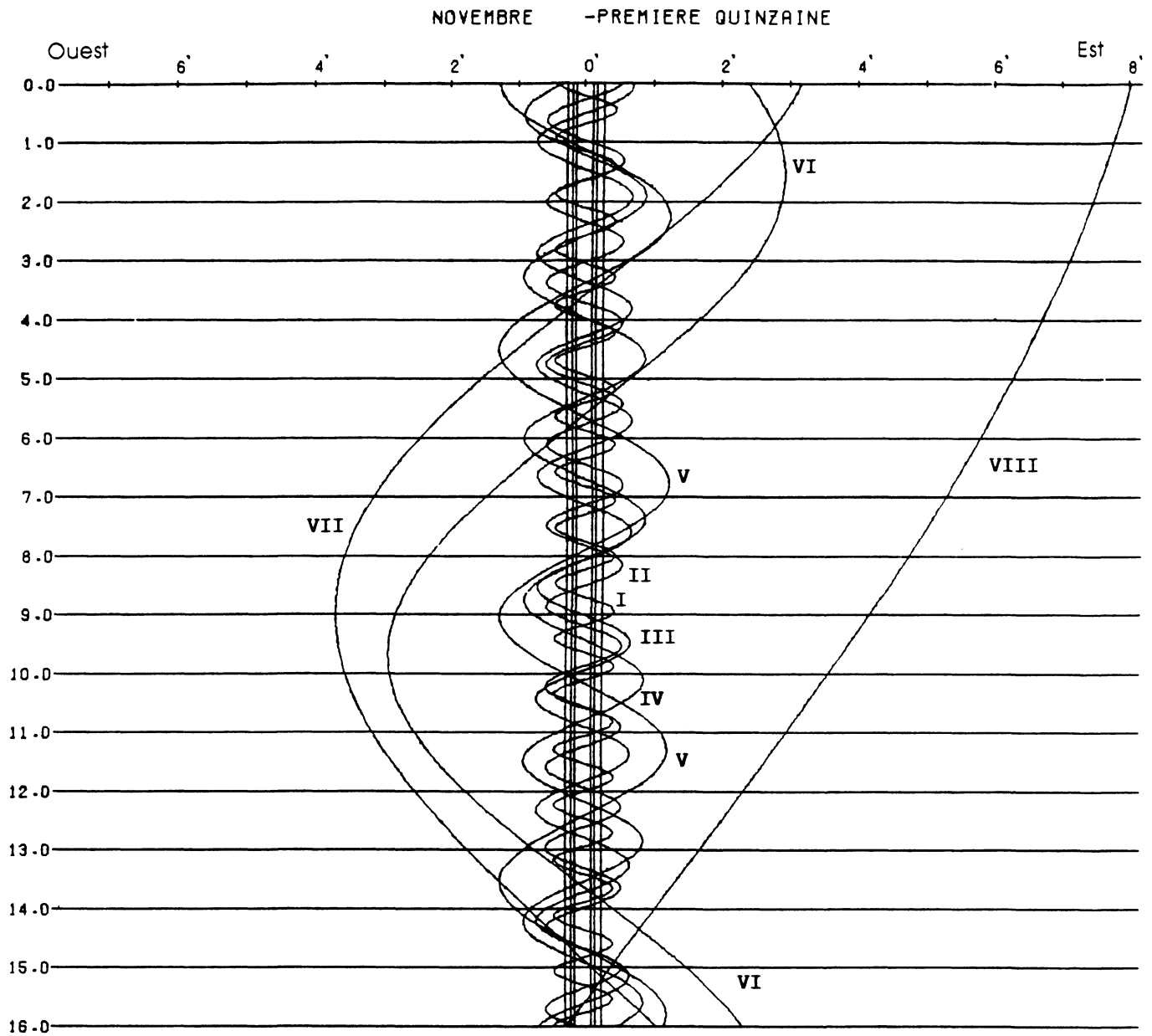

DANS LE SENS OUEST-EST.LES SATELLITES PASSENT AU-DELA DE SATURNE

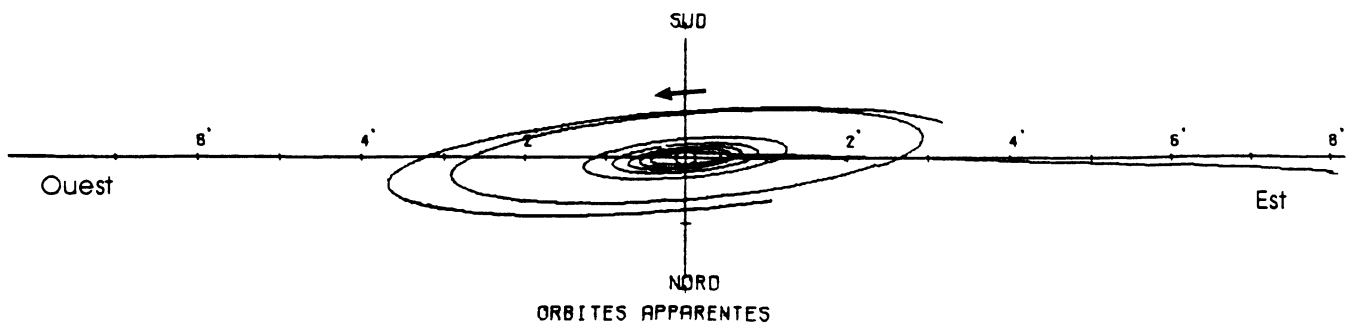

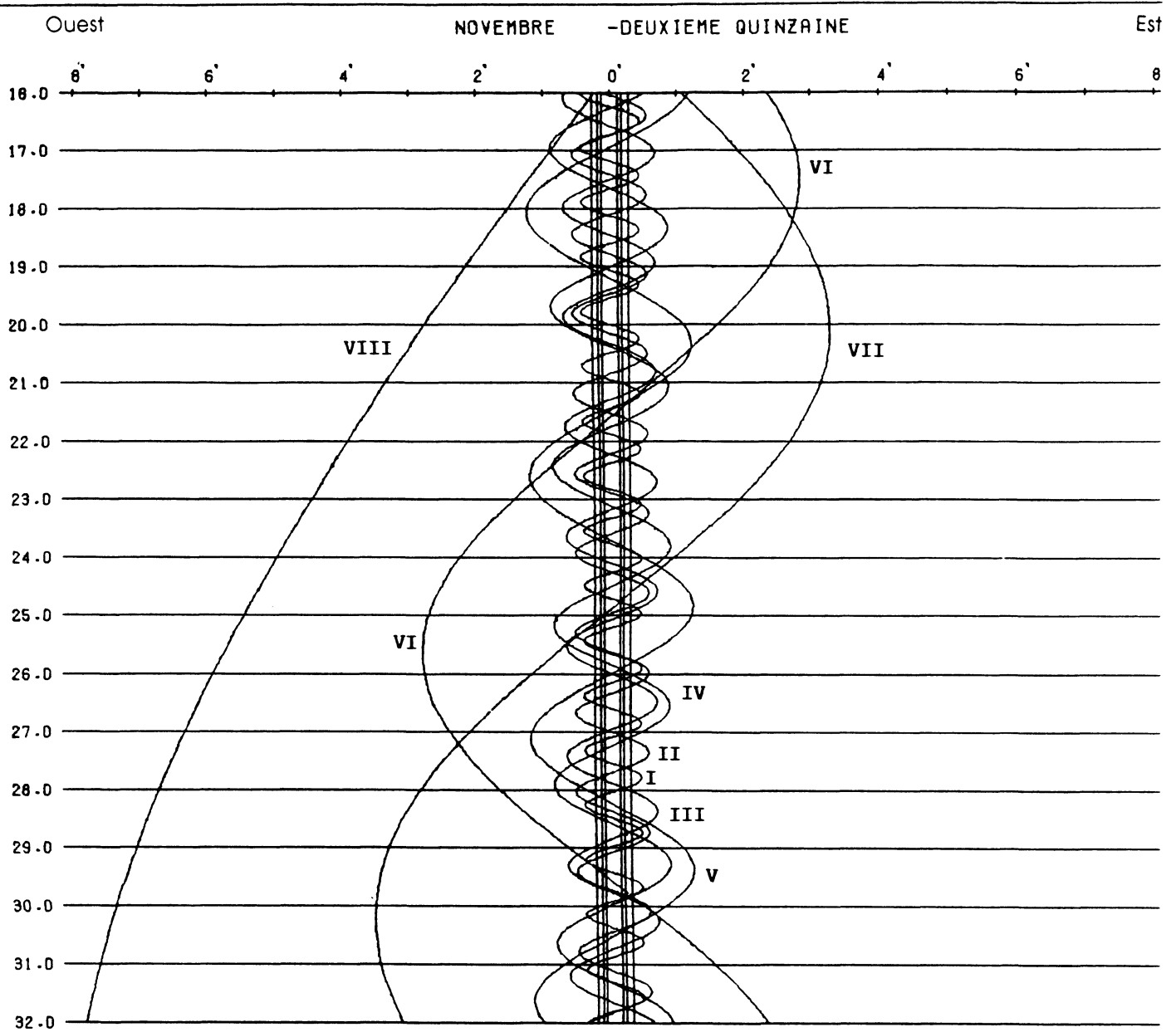

DANS LE SENS OUEST-EST, LES SATELLITES PASSENT AU-DELA DE SATURNE

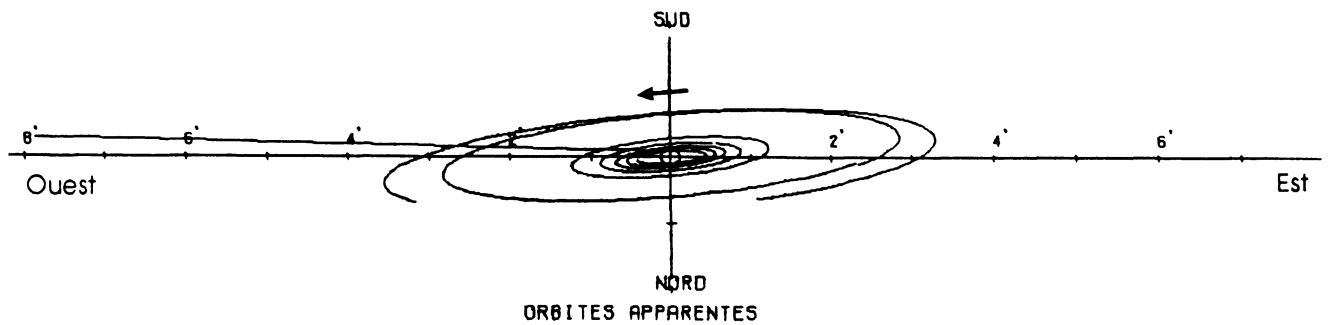

1993 .-CONFIGURATIONS DES SATELLITES DE SATURNE

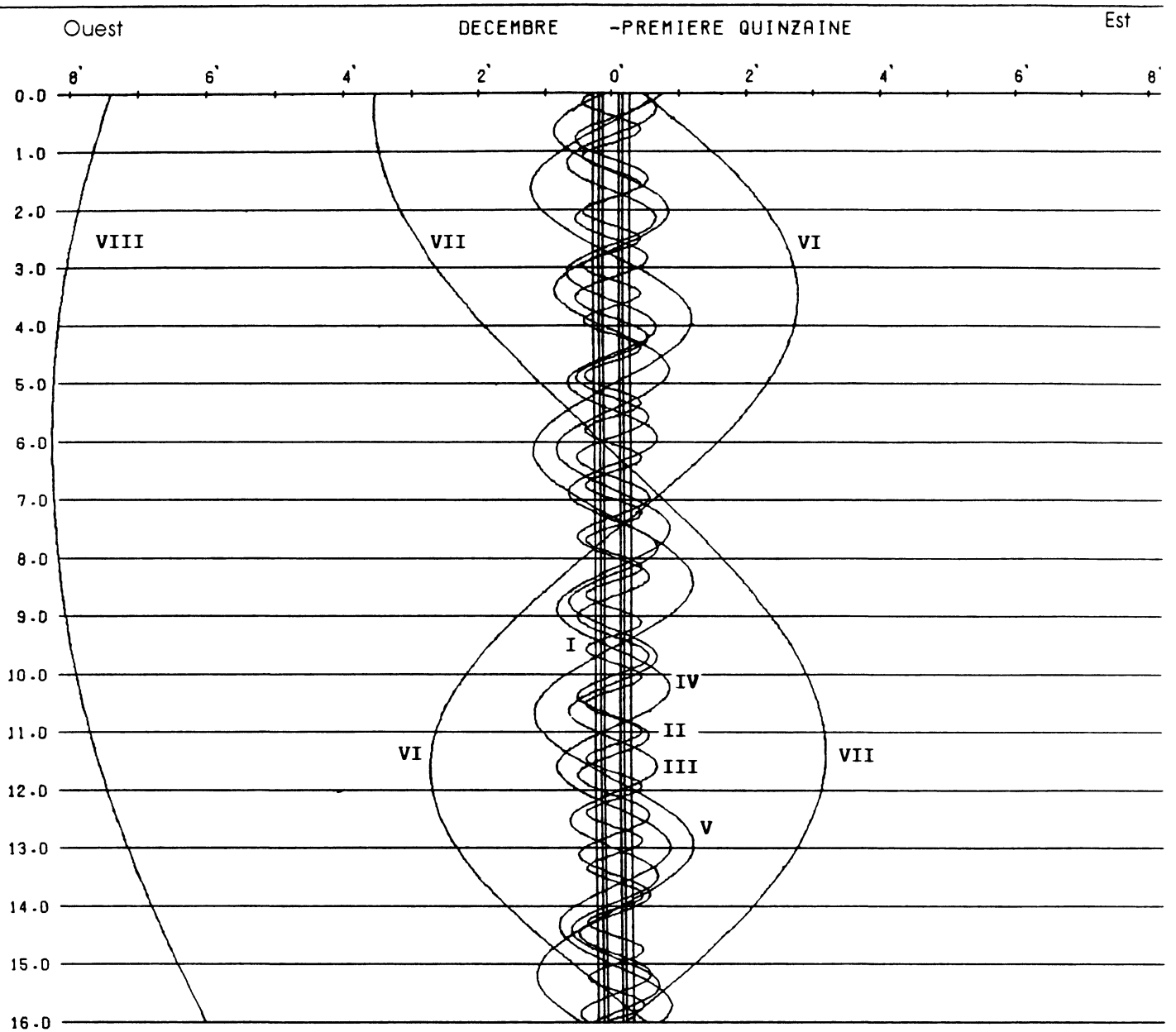

DANS LE SENS OUEST-EST.LES SATELLITES PASSENT AU-DELA DE SATURNE

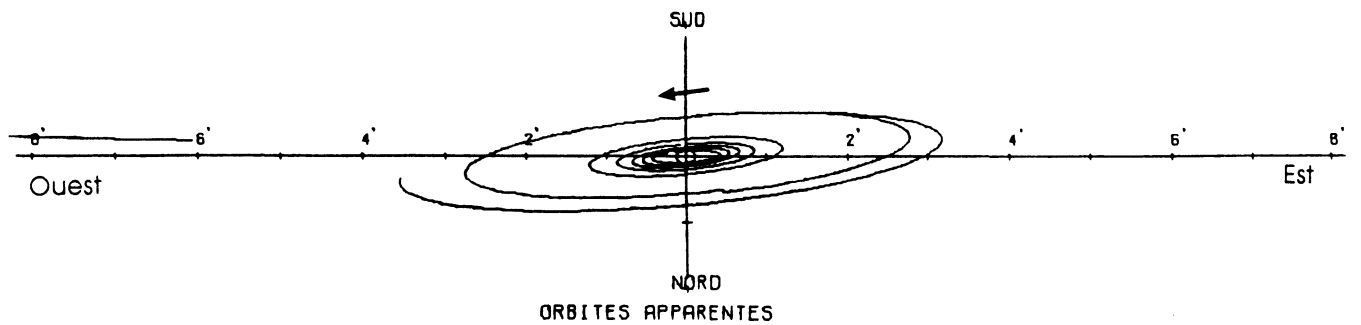

1993 .-CONFIGURATIONS DES SATELLITES DE SATURNE

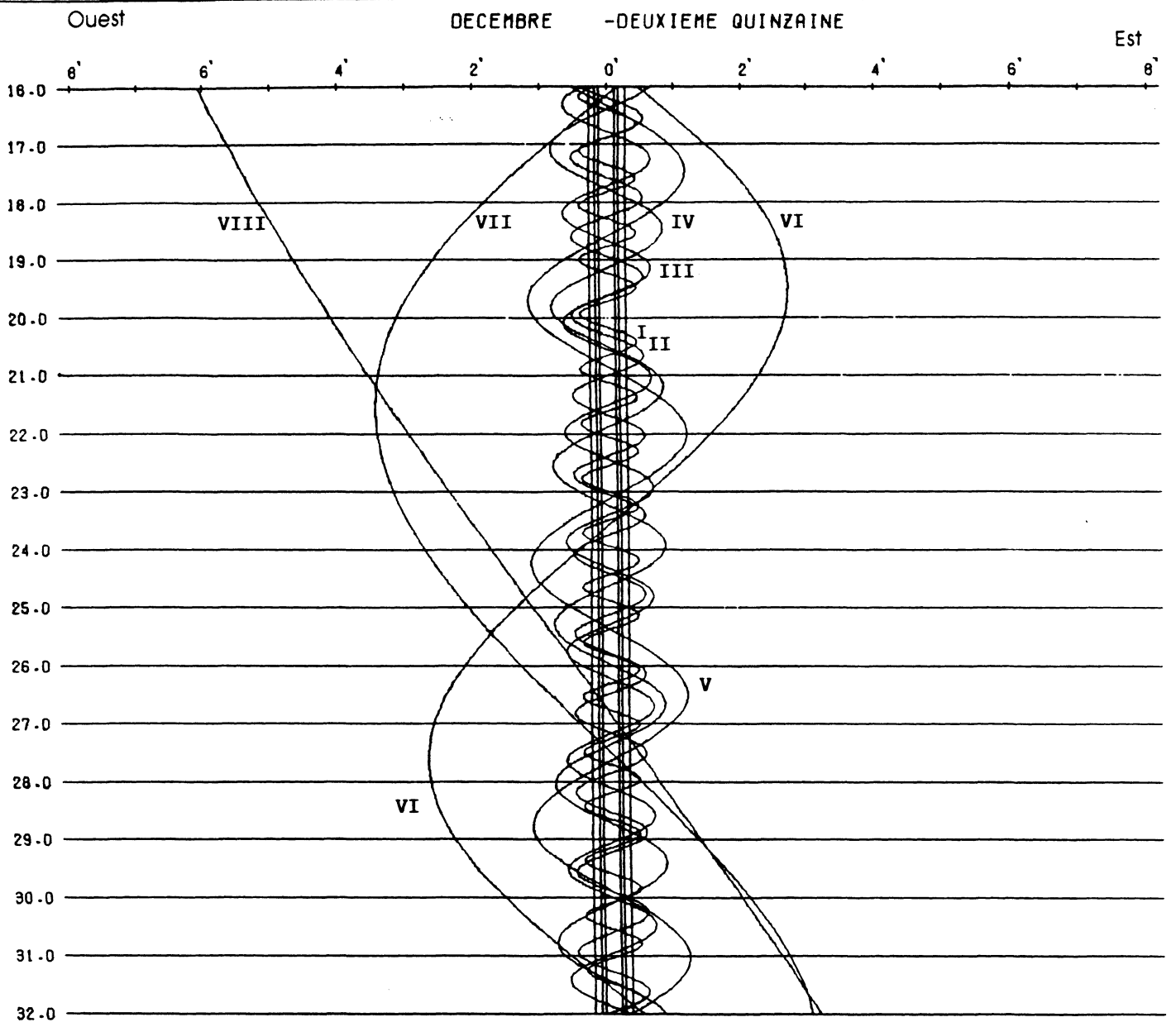

DANS LE SENS OUEST-EST. LES SATELLITES PASSENT AU-DELA DE SATURNE

