



**HAL**  
open science

## Satellites de Saturne I à VIII : configurations et Phénomènes pour 1997

J.-E. Arlot, Th. Derouazi, Ch. Ruatti, W. Thuillot

► **To cite this version:**

J.-E. Arlot, Th. Derouazi, Ch. Ruatti, W. Thuillot. Satellites de Saturne I à VIII : configurations et Phénomènes pour 1997. [Rapport de recherche] Institut de mécanique céleste et de calcul des éphémérides(IMCCE). 1996, 53 p., figures, tableaux. hal-01467537

**HAL Id: hal-01467537**

**<https://hal-lara.archives-ouvertes.fr/hal-01467537v1>**

Submitted on 14 Feb 2017

**HAL** is a multi-disciplinary open access archive for the deposit and dissemination of scientific research documents, whether they are published or not. The documents may come from teaching and research institutions in France or abroad, or from public or private research centers.

L'archive ouverte pluridisciplinaire **HAL**, est destinée au dépôt et à la diffusion de documents scientifiques de niveau recherche, publiés ou non, émanant des établissements d'enseignement et de recherche français ou étrangers, des laboratoires publics ou privés.

# SATELLITES DE SATURNE

## I à VIII

### CONFIGURATIONS ET PHÉNOMÈNES POUR 1997

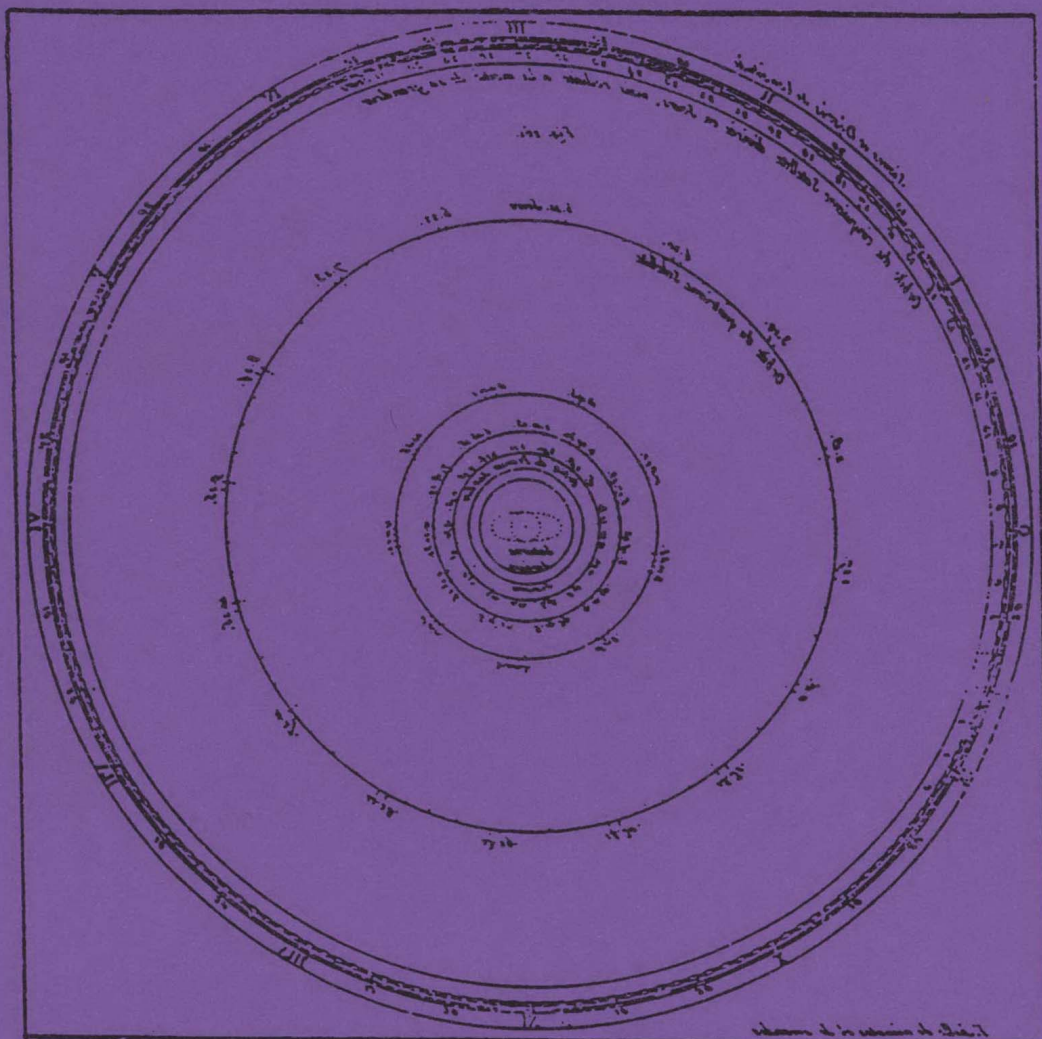

Supplément à la CONNAISSANCE DES TEMPS

à l'usage des observateurs

Bureau des longitudes, URA 707 DU CNRS

Paris, décembre 1996

**CONFIGURATIONS ET PHÉNOMÈNES  
DES HUIT PREMIERS SATELLITES DE SATURNE  
POUR 1997**

**CONFIGURATIONS AND PHENOMENA  
OF THE FIRST EIGHT SATELLITES OF SATURN  
FOR 1997**

Bureau des longitudes, 77 avenue Denfert-Rochereau, F-75014 PARIS.  
Supplément à la *Connaissance des Temps* à l'usage des observateurs.  
Rédaction et calculs : J.E. ARLOT, Th. DEROUAZI, Ch. RUATTI, W. THUILLOT.  
Paris, décembre 1996

LE SERVICE MINITEL  
DU BUREAU DES LONGITUDES  
3616 code BDL

Le *Service Minitel* du Bureau des Longitudes met à la disposition des professionnels et des amateurs les informations suivantes:

- les actualités astronomiques et le ciel du mois;
- les heures du lever et du coucher du Soleil et de la Lune, les azimuts et hauteurs du Soleil en n'importe quel lieu, de -4000 à 2500;
- les phases de la Lune et les dates des saisons de -4000 à 2500;
- les éclipses du Soleil et de la Lune pour six années;
- les positions apparentes géocentriques, les hauteurs et azimuts, les heures du lever et du coucher du Soleil, de la Lune et des planètes de 1900 à 2020;
- les coordonnées héliocentriques moyennes des planètes de 1900 à 2020 dans le repère de la date;
- les positions des satellites naturels, les phénomènes des satellites galiléens pour quatre ans, et les phénomènes des satellites de Saturne pour la période actuelle;
- les définitions et les concordances des calendriers, les fêtes légales et religieuses, l'heure légale en France, les dates de changement d'heure et le calcul du jour de la semaine.

**Couverture :** “ Instrument pour trouver les configurations des satellites de Saturne ”, extrait de Lalande 1792, *Astronomie* tome 3.

---

Imprimé au Bureau des Longitudes

ISSN 0769 – 1025

Dépôt légal : décembre 1996

LES SERVEURS  
DU BUREAU DES LONGITUDES SUR INTERNET

<http://www.bdl.fr> et <ftp://ftp.bdl.fr>

Le Bureau des longitudes diffuse de nombreuses informations, périodiquement remises à jour, grâce à ses serveurs sur le réseau *Internet*. Outre des informations générales sur l'histoire et les activités du Bureau des longitudes, on peut y trouver des données scientifiques concernant les objets du système solaire:

- éphémérides de planètes et de satellites, phénomènes;
- éléments orbitaux de comètes et d'astéroïdes;
- données sur les éclipses de Soleil;
- images astronomiques.

Un serveur WEB est accessible à l'adresse <http://www.bdl.fr>. Un serveur ftp anonyme est accessible à l'adresse: <ftp://ftp.bdl.fr>.

---

THE INTERNET SERVERS  
OF BUREAU DES LONGITUDES

<http://www.bdl.fr> and <ftp://ftp.bdl.fr>

Bureau des longitudes publishes information thanks to *Internet* servers. Besides general information concerning history and activities of Bureau des longitudes, one may access scientific data on:

- ephemerides of planets and satellites, phenomena;
- orbital elements of comets and asteroids;
- data on Solar eclipses;
- astronomical images.

The address of the WEB Server is: <http://www.bdl.fr>. One can also access an anonymous-ftp server at the address: <ftp://ftp.bdl.fr>.

## PUBLICATIONS DU BUREAU DES LONGITUDES

### Publications éditées par Les Éditions de Physique, Les Ulis

*Connaissance des Temps 1997.*

*Introduction aux éphémérides astronomiques. Supplément explicatif à la Connaissance des Temps (à paraître en 1997).*

### Publications éditées par Dunod-Bordas, Paris

*Éphémérides nautiques 1997.*

*Encyclopédie scientifique de l'univers.*

La physique (1981).

La Terre, les eaux, l'atmosphère (réédition, 1984).

Les étoiles, le système solaire (réédition, 1986).

La galaxie, l'univers extragalactique (réédition, 1988).

### Publications éditées par Masson, Paris

*Annuaire du Bureau des longitudes. Éphémérides astronomiques 1997.*

*Cahiers des sciences de l'univers*, publiés sous l'égide du Bureau des longitudes.

1. Les profondeurs de la Terre par J.P. Poirier.
2. Stratosphère et couche d'ozone par G. Mégie.
3. Chronique de l'espace temps – Du vide quantique à l'expansion cosmique par A. Mazure, G. Mathez, Y. Mellier.

### Publications éditées par le Bureau des longitudes

*Supplément à la Connaissance des Temps*

Éphémérides des satellites faibles de Jupiter (VI, VII, VIII, IX) et de Saturne (IX) pour 1997.

Satellites galiléens de Jupiter. Phénomènes et configurations pour 1997.

Satellites de Saturne I à VIII. Configurations et phénomènes pour 1997.

*Le calendrier républicain* (réédition, 1995).

*Notes scientifiques et techniques du Bureau des longitudes.*

<b>Tables des matières</b>	<b>Page</b>
Avertissement .....	7
Données sur les satellite de Saturne .....	9
Usage des configurations .....	10
Configurations .....	13
Phénomènes .....	39

<i>Tables of contents</i>	<i>Page</i>
<i>Foreword</i> .....	7
<i>Data on the Saturnian satellites</i> .....	9
<i>The use of configurations</i> .....	10
<i>Configurations</i> .....	13
<i>Phenomena</i> .....	39

## Avertissement

Le Bureau des longitudes publie chaque année dans la *Connaissance des Temps*, les positions des planètes, du Soleil et de la Lune sous forme de coefficients de Tchébychev. Depuis 1996, cet ouvrage donne également les positions des satellites de Mars, des satellites galiléens de Jupiter, des huit premiers satellites de Saturne et des cinq satellites d'Uranus sous forme de fonctions mixtes dépendant directement du temps.

Des suppléments à la *Connaissance des Temps* sont publiés également et donnent:

— les positions des satellites faibles de Jupiter (VI, VII, VIII et IX) et de Phœbé (satellite IX de Saturne) sous forme de coefficients de Tchébychev;

— les configurations et les phénomènes des satellites galiléens de Jupiter.

Le présent supplément donne les configurations des huit premiers satellites de Saturne dans le but, principalement, d'aider les observateurs à identifier ces satellites. La précision de lecture des courbes permet une précision de positionnement de l'ordre de 10 à 15 secondes de degré (").

Il donne également les dates des phénomènes (éclipses, occultations, passages devant la planète et passages d'ombres). Ces phénomènes se produisent tous les quinze ans.

## Foreword

*The Bureau des longitudes publishes each year in the *Connaissance des Temps*, the positions of the planets, the Sun and the Moon as Chebychev polynomials. Starting 1996, this ephemeris gives also the positions of the satellites of Mars, of the Galilean satellites of Jupiter, of the first eight satellites of Saturn and of the five satellites of Uranus as mixed functions depending directly on the time.*

*Several supplements to the *Connaissance des Temps* are also published and give:*

*— the positions of the faint satellites of Jupiter (VI, VII, VIII and IX), of Phoebe (satellite IX of Saturn) as Chebychev polynomials;*

*— the configurations and the phenomena of the Galilean satellites of Jupiter.*

*The present supplement gives the configurations of the first eight satellites of Saturn in order to help the observers to identify those satellites. The precision of the curves allows an accuracy in the position of about 10 to 15 seconds of degree (").*

*Besides these informations the present booklet gives the dates of phenomena (eclipses, occultations, transit in front of Saturn, transit of shadows). These phenomena occur every fifteen years.*

J.-E. ARLOT  
Directeur du Bureau des Longitudes  
URA 707 du CNRS



## DONNÉES SUR LES SATELLITES DE SATURNE

NOM	masse	rayon	période rotation sidérale	albédo géomé- métrique	magnitude visuelle	période orbitale	élon- gation max.	a	e	I sur l'équat.
unité →	masse de Saturne	km	jour			jour	" "	10 <sup>3</sup> km		degré
I Mimas	$8.00 \times 10^{-6}$	209 × 196 × 191	(S)	0.77	12.9	0.942 422	30	184.54	0.019 1	1.56
II Encelade	$1.3 \times 10^{-7}$	256 × 247 × 245	(S)	1.04	11.5	1.370 218	38	238.20	0.004 9	0.03
III Téthys	$1.33 \times 10^{-6}$	536 × 528 × 526	(S)	0.8	10.3	1.887 803	48	294.992	0	1.10
IV Dioné	$1.85 \times 10^{-6}$	560	(S)	0.55	10.4	2.736 914	1 01	377.654	0.002 2	0.01
V Rhéa	$4.38 \times 10^{-6}$	764	(S)	0.65	9.7	4.517 503	1 25	527.367	0.000 3 <sup>(6)</sup>	0.35
VI Titan	$2.3659 \times 10^{-4}$	2 575	(S)	0.21	8.3	15.945 446	3 17	1 221.803	0.029 1	0.30
VII Hypérion	$3 \times 10^{-8}$	180 × 140 × 112		0.19/0.25	14.2	21.276 673	3 59	1 481.1	0.103 5	0.64
VIII Japet	$3.31 \times 10^{-6}$	718	(S)	0.5-0.07	10.2/11.9	79.330 954	9 34	3 561.85	0.028 3	18.5 <sup>(1)</sup>
IX Phœbé	$7 \times 10^{-10}$	115 × 110 × 105	0.4	0.07	16.5	(R)546.6	34 51	12 893	0.175 6	173.7 <sup>(1)</sup>
X Janus <sup>(5)</sup>		97 × 95 × 77	(S)	0.4	14	0.694 66	324	151.47	0.007	0.14
XII Epiméthée <sup>(5)</sup>		69 × 55 × 55	(S)	0.4	15	0.694 32	24	151.42	0.009	0.34
XII Hélène <sup>(2)</sup>		18 × 16 × 15		0.5	17	2.739 1	1 01	378.06	0.005	0.15
XIII Télésto <sup>(3)</sup>		15 × 12 × 7		0.6	18	1.887 8	48	294.66		
XIV Calypso <sup>(3)</sup>		15 × 8 × 8		0.8	18.5	1.887 8	48	294.66		
XV Atlas		18 × 17 × 13		0.4	18	0.601 9	22	137.67	0.002	0.3
XV Prométhée <sup>(4)</sup>		74 × 50 × 34		0.6	15	0.612 99	23	139.35	0.002	0
XVII Pandore <sup>(4)</sup>		55 × 44 × 31		0.6	15.5	0.628 50	23	141.70	0.004	0
XVIII Pan		10				0.575	21	133.53		
Anneaux D		67 <sup>(7)</sup>								
Anneaux C	$1.7 \times 10^{-9}$	74.5/92.01 <sup>(7)</sup>				0.2 à 0.6			0	0
Anneaux B	$4.2 \times 10^{-8}$	92.01/117.51 <sup>(7)</sup>								
Anneaux A	$1.1 \times 10^{-8}$	122.20/136.77 <sup>(7)</sup>								
Anneaux F		140.2 <sup>(7)</sup>				0.618			0.003	0
Anneaux G		169 <sup>(7)</sup>								
Anneaux E		180/480 <sup>(7)</sup>								

(S) : révolution synchrone

(R) : révolution rétrograde

(1) : inclinaison par rapport à l'écliptique.

Les éphémérides de Phœbé sont données sous la forme de coefficients de Tchébychev dans le " *Supplément à la Connaissance des Temps: Satellites faibles...* "

(2) : Hélène : même orbite que Dioné

(3) : Télésto et Calypso : même orbite que Téthys

(4) : satellites coorbitaux " gardiens " de l'anneau F

(5) : Janus et Epiméthée : même orbite

(6) : excentricité propre. L'excentricité forcée due à Titan est de 0.0010

(7) : en milliers de km

### THE USE OF CONFIGURATIONS

The configurations allow the identification of the satellites and the determination of their position in tangential equatorial coordinates referred to the planet Saturn with the precision as follow (for a lecture on the curves with an accuracy of 0.5 millimeter):

I	: 2 to 10"	V	: 2 to 3"
II	: 2 to 8"	VI	: 2 to 3"
III	: 2 to 6"	VII	: 2 to 3"
IV	: 2 to 4"	VIII	: 2 to 3"

This example shows how to proceed :

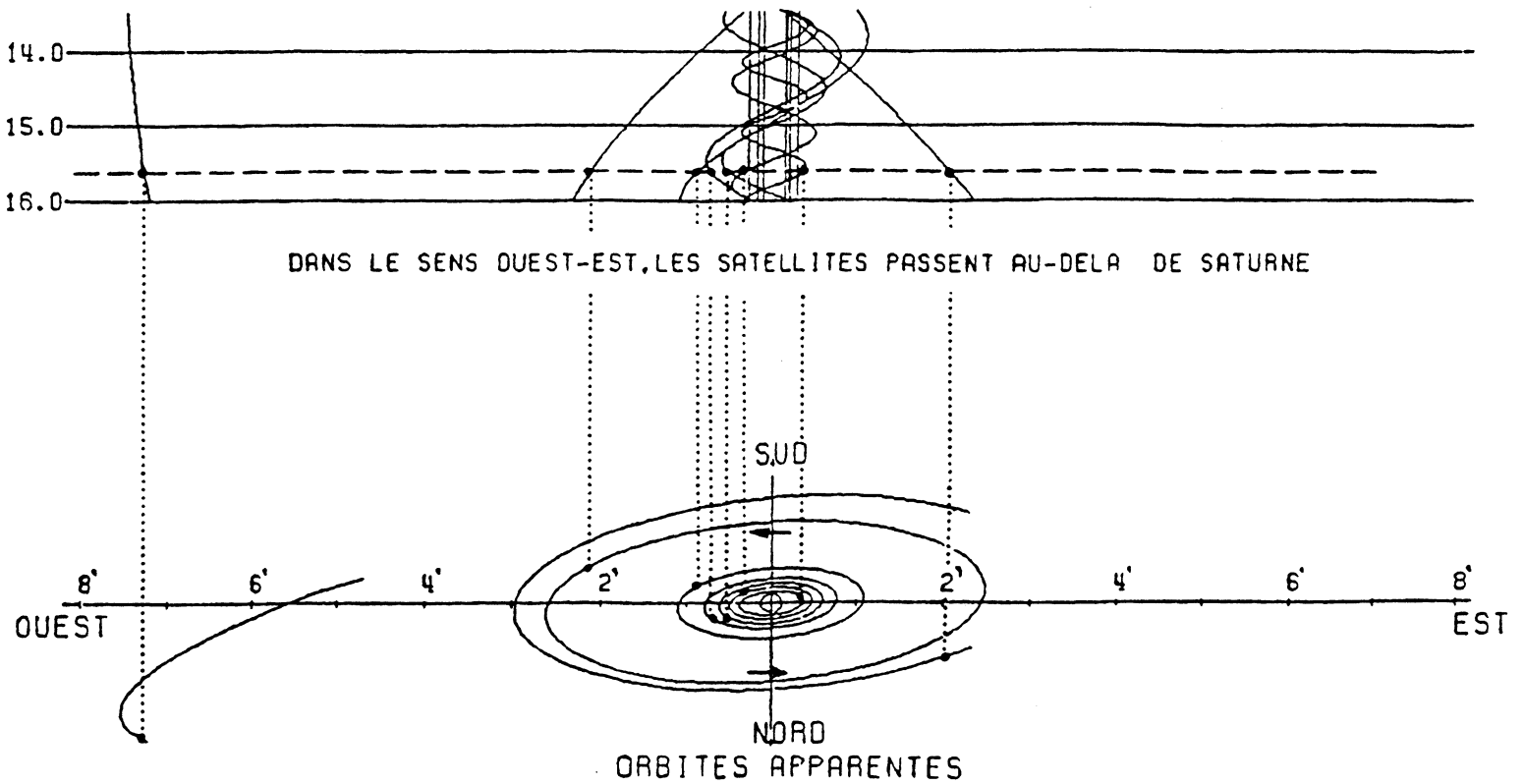

The distances  $\Delta \alpha \cos \delta$ , measured on the curves for the choosen date, are plotted in abscissa on west-east axis. The ordinate is given by the apparent orbits. The direction of the rotation indicates if the satellite is before or behind the planet on its orbit.

## USAGE DES CONFIGURATIONS

Les configurations permettent d'identifier les satellites et de déterminer leur position en coordonnées tangentielles équatoriales relatives à Saturne avec la précision suivante (pour une lecture des courbes à 0,5 millimètre près) :

I	: 2 à 10"	V	: 2 à 3"
II	: 2 à 8"	VI	: 2 à 3"
III	: 2 à 6"	VII	: 2 à 3"
IV	: 2 à 4"	VIII	: 2 à 3"

L'exemple suivant montre comment procéder :

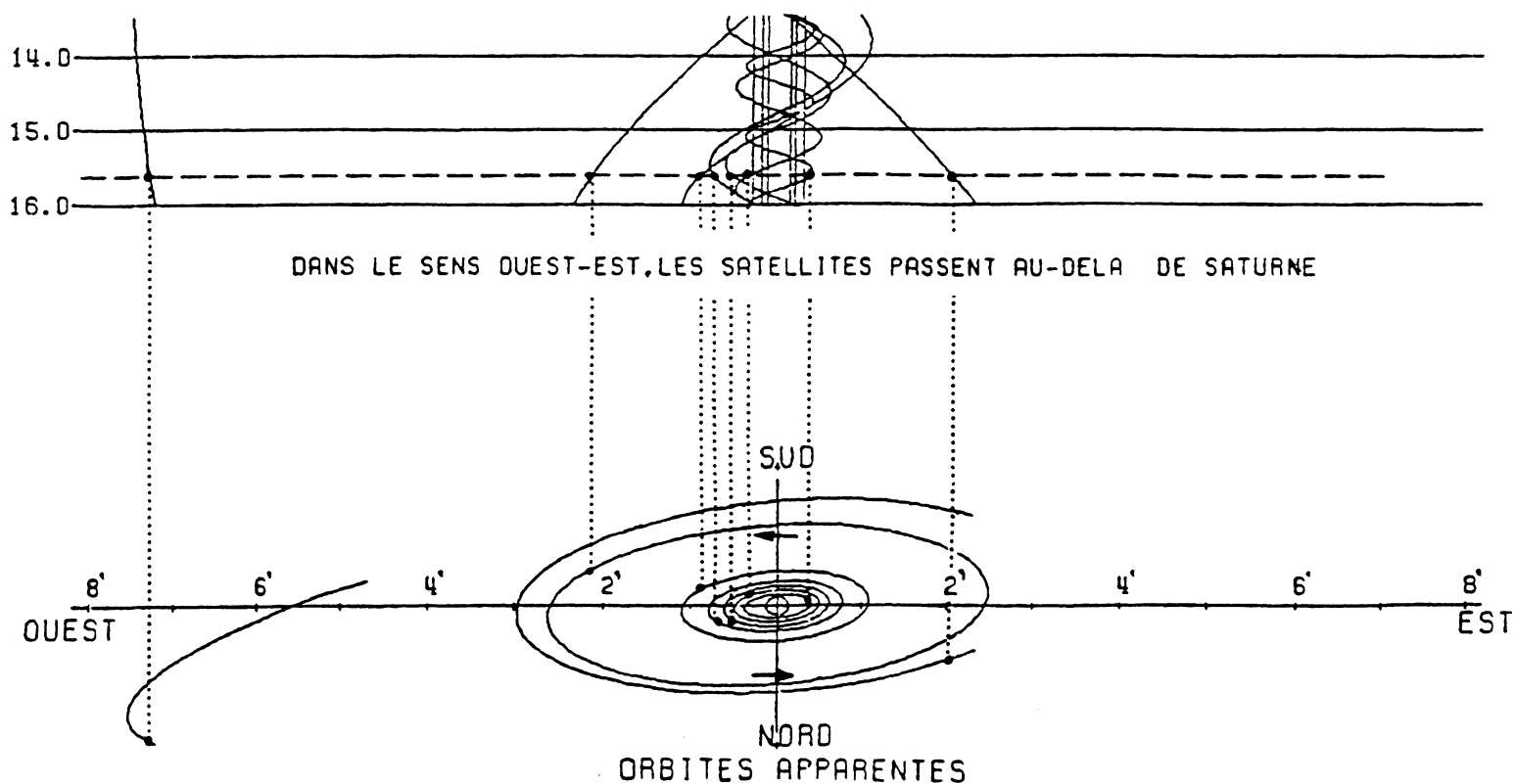

On reporte en abscisse sur l'axe ouest-est les distances  $\Delta \alpha \cos \delta$  mesurées, pour la date voulue, sur les courbes. L'ordonnée est donnée par les orbites apparentes. L'indétermination avant/arrière est levée grâce au sens de rotation des satellites.

# **CONFIGURATIONS**

1997 .-CONFIGURATIONS DES SATELLITES DE SATURNE

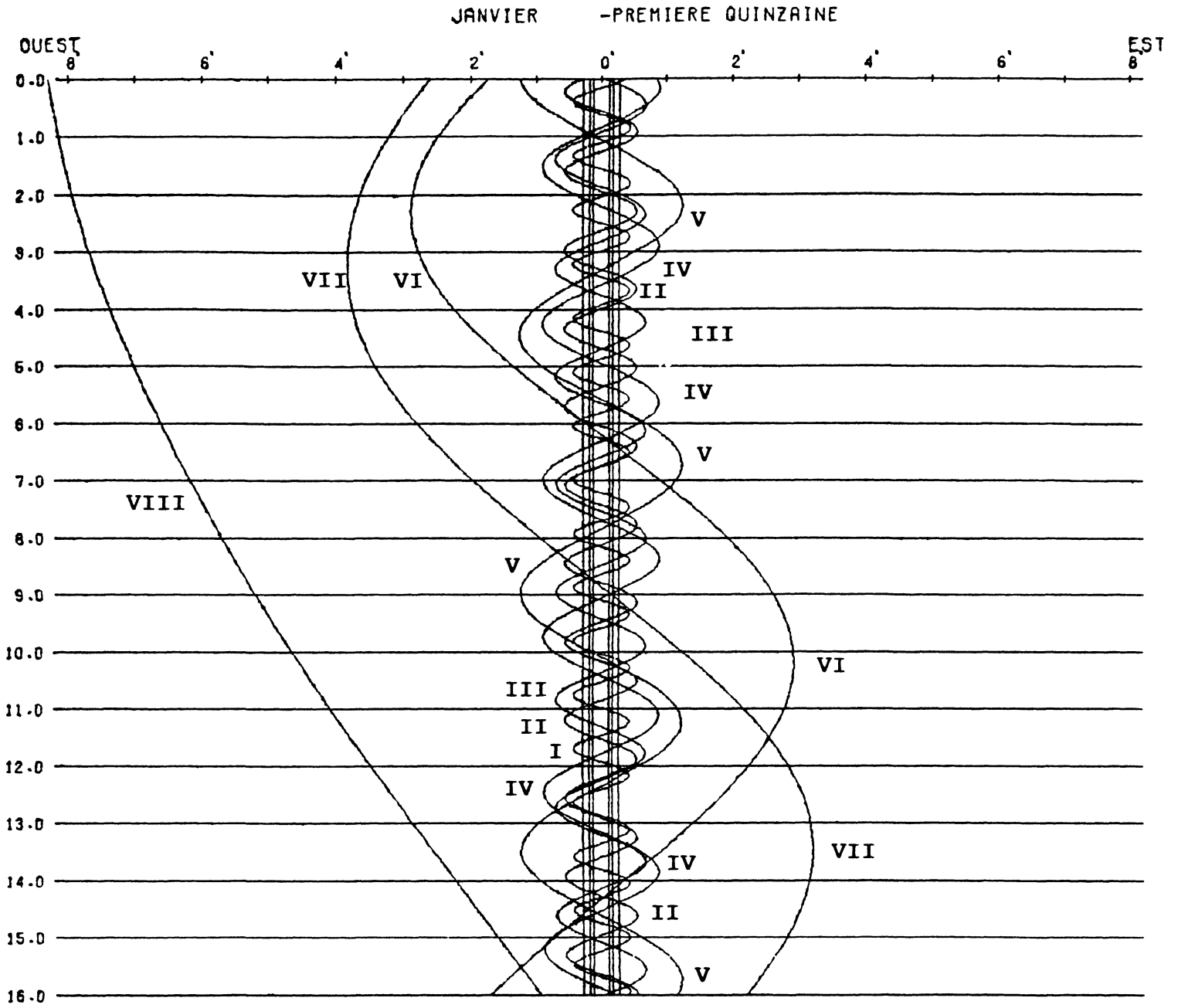

DANS LE SENS OUEST-EST, LES SATELLITES PASSENT AU-DELA DE SATURNE

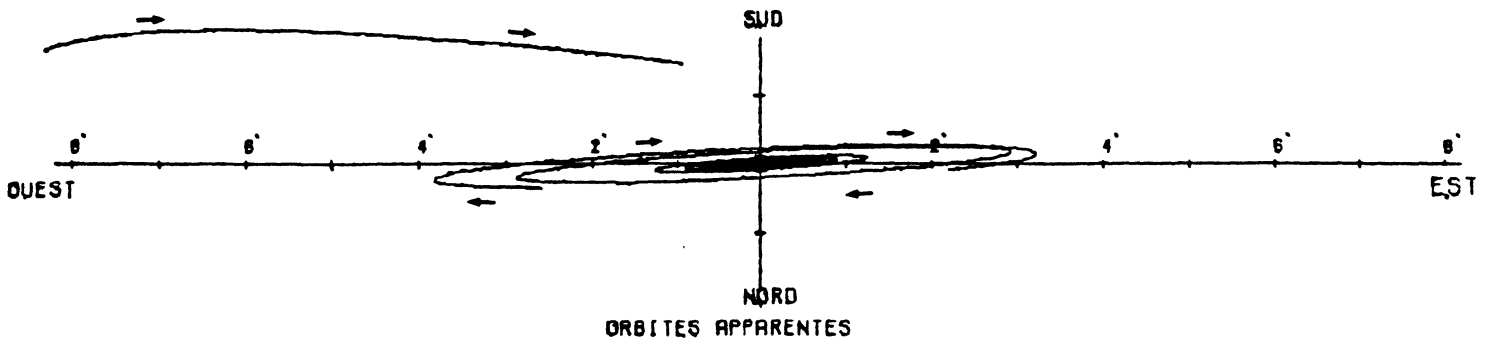

1997 .-CONFIGURATIONS DES SATELLITES DE SATURNE

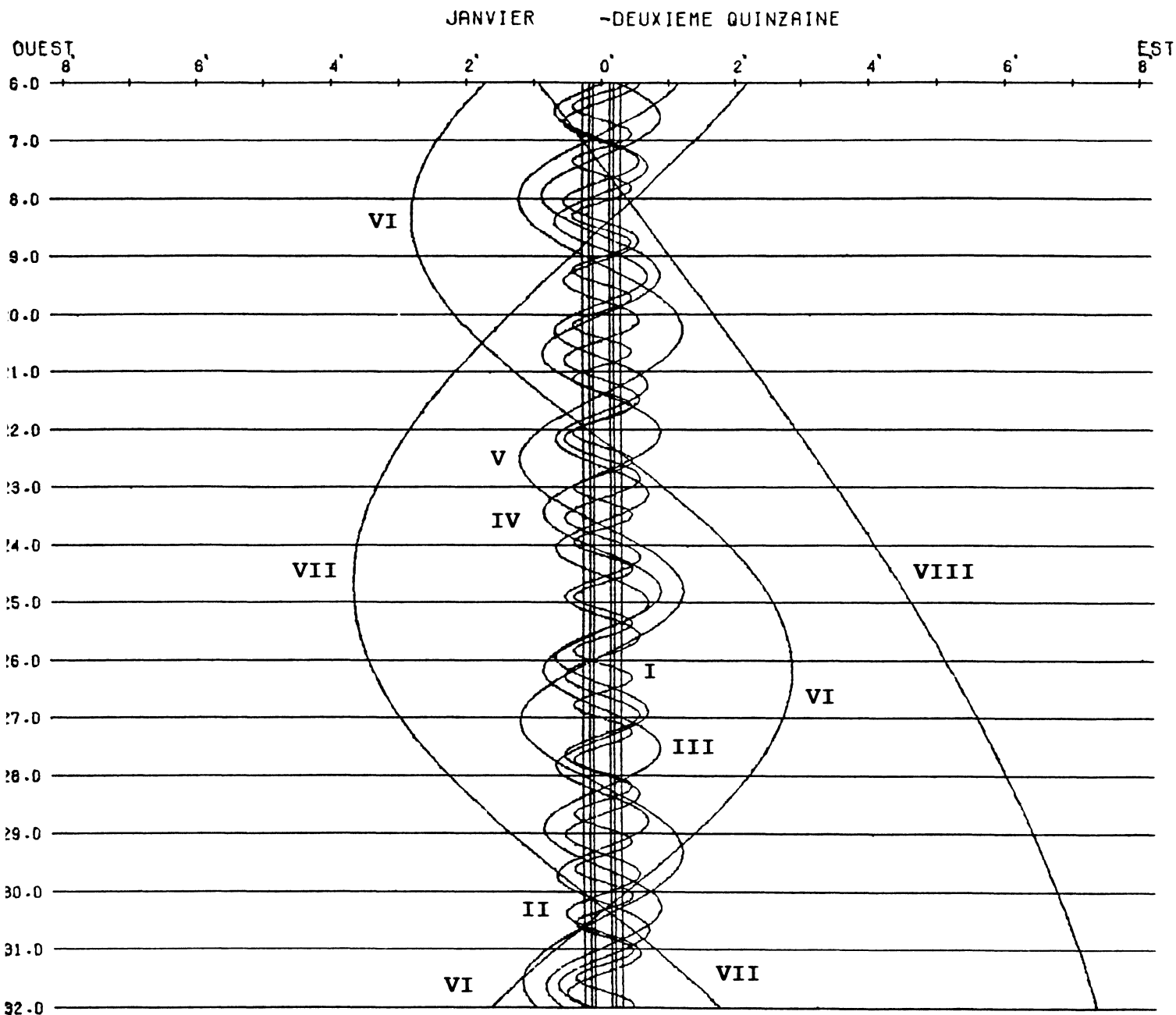

DANS LE SENS OUEST-EST. LES SATELLITES PASSENT AU-DELA DE SATURNE

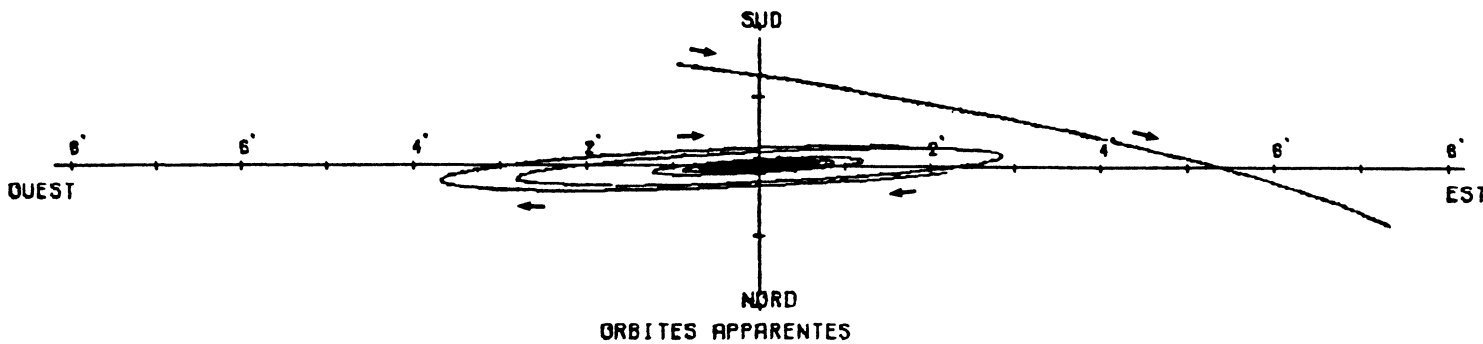

1997 .-CONFIGURATIONS DES SATELLITES DE SATURNE

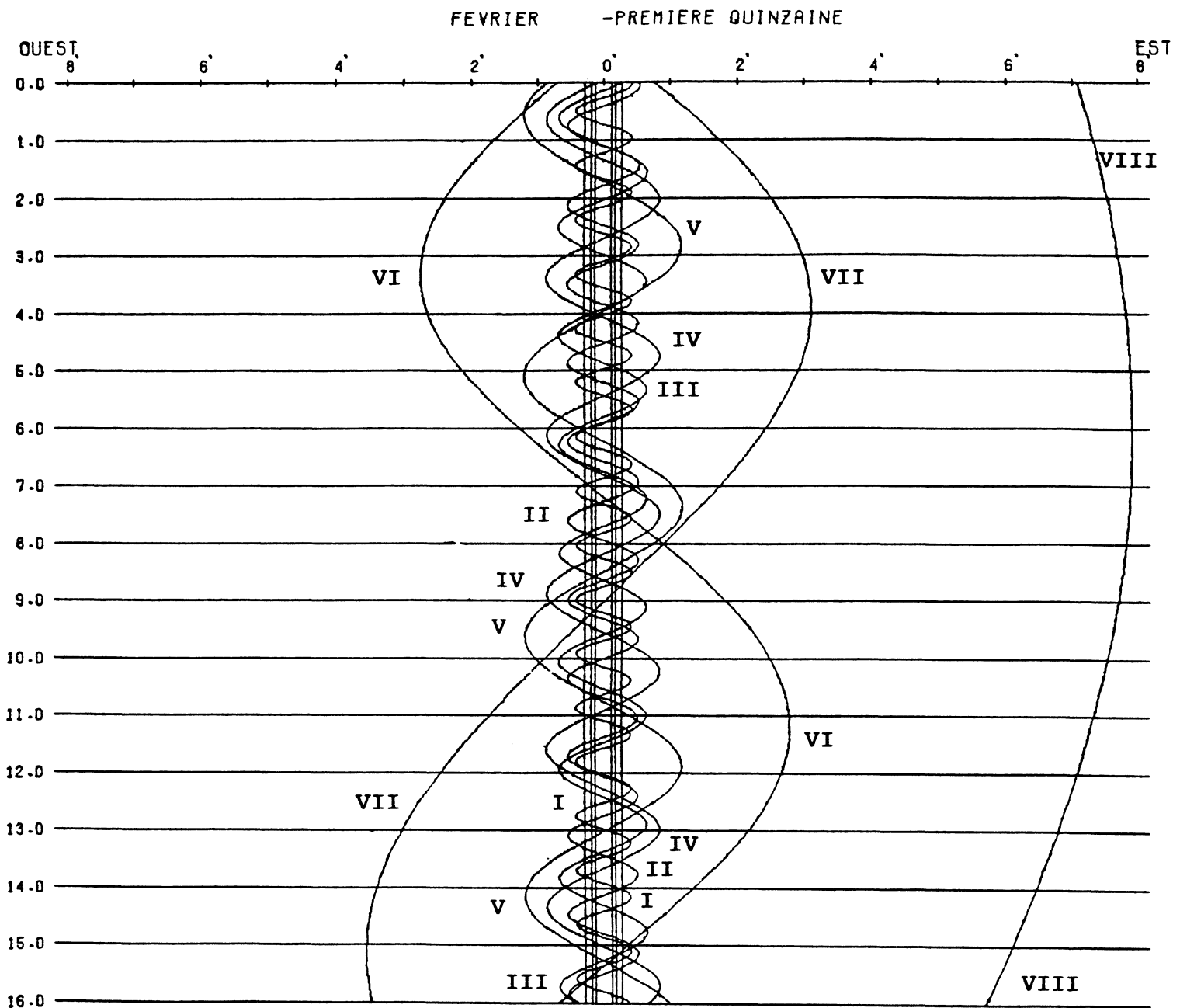

DANS LE SENS OUEST-EST. LES SATELLITES PASSENT AU-DELA DE SATURNE

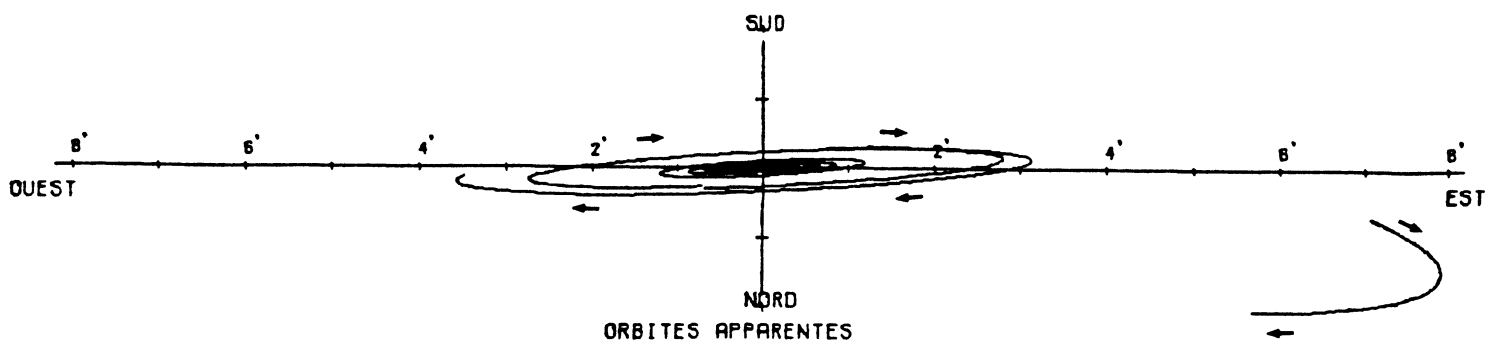

1997.-CONFIGURATIONS DES SATELLITES DE SATURNE

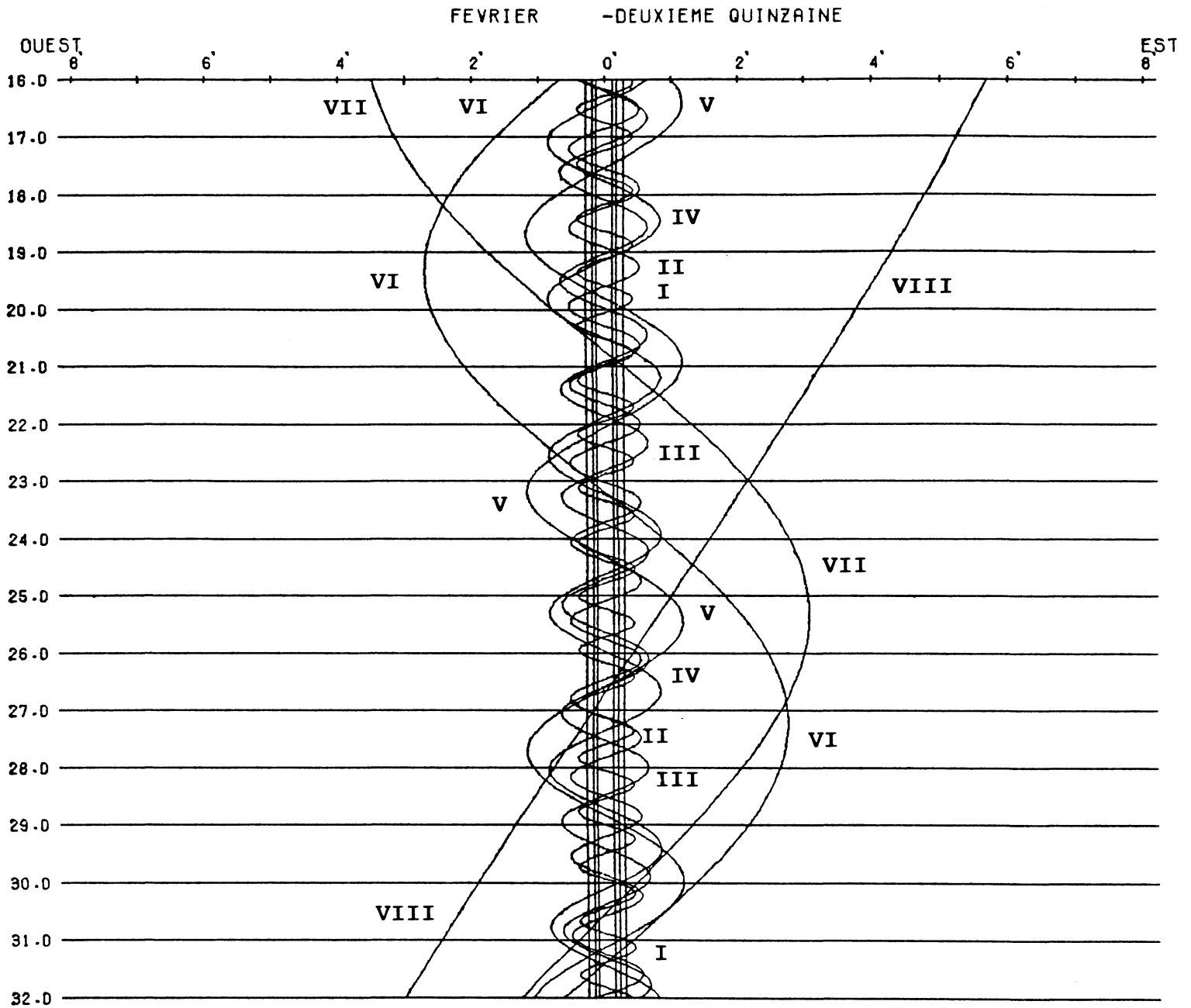

DANS LE SENS OUEST-EST, LES SATELLITES PASSENT AU-DELA DE SATURNE

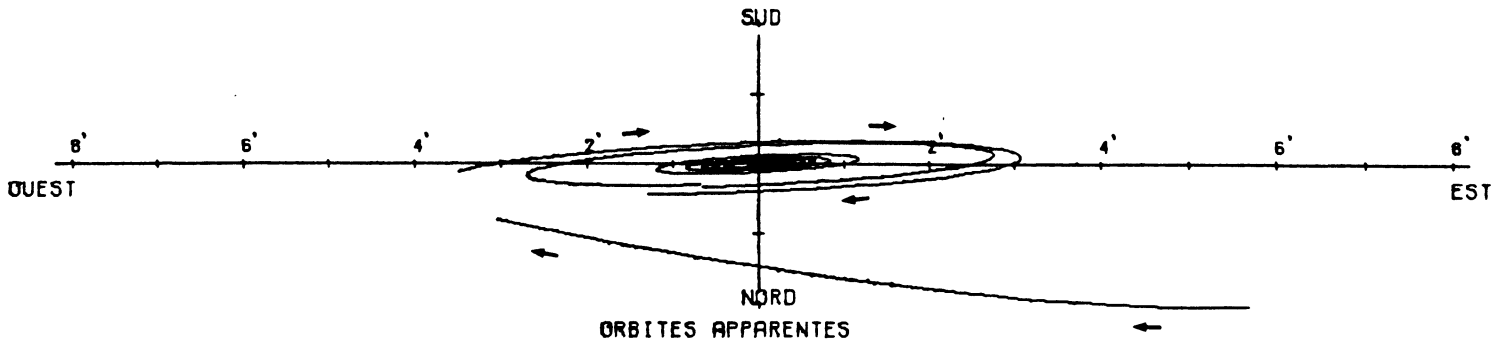



1997 .-CONFIGURATIONS DES SATELLITES DE SATURNE

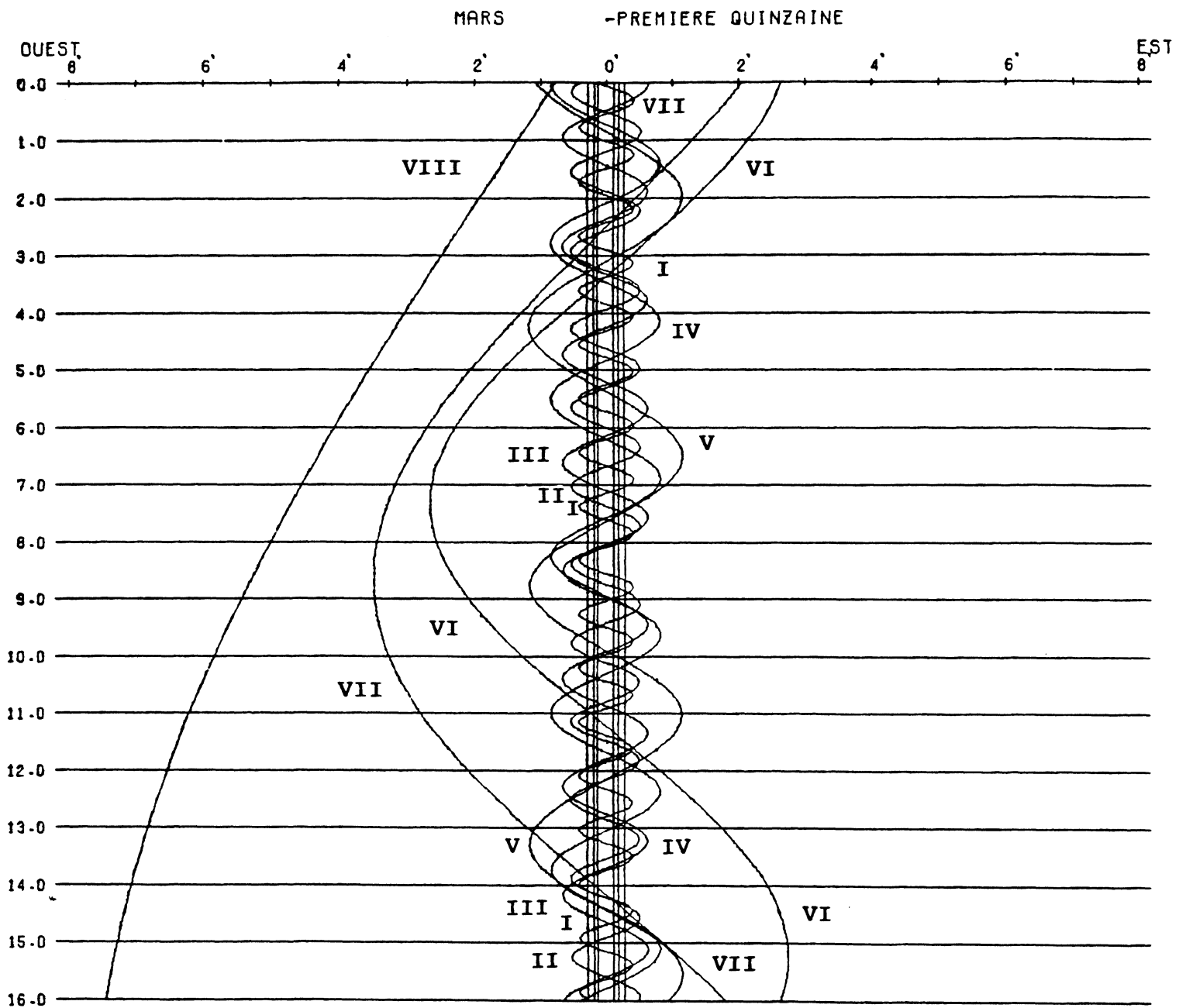

DANS LE SENS OUEST-EST, LES SATELLITES PASSENT AU-DELA DE SATURNE

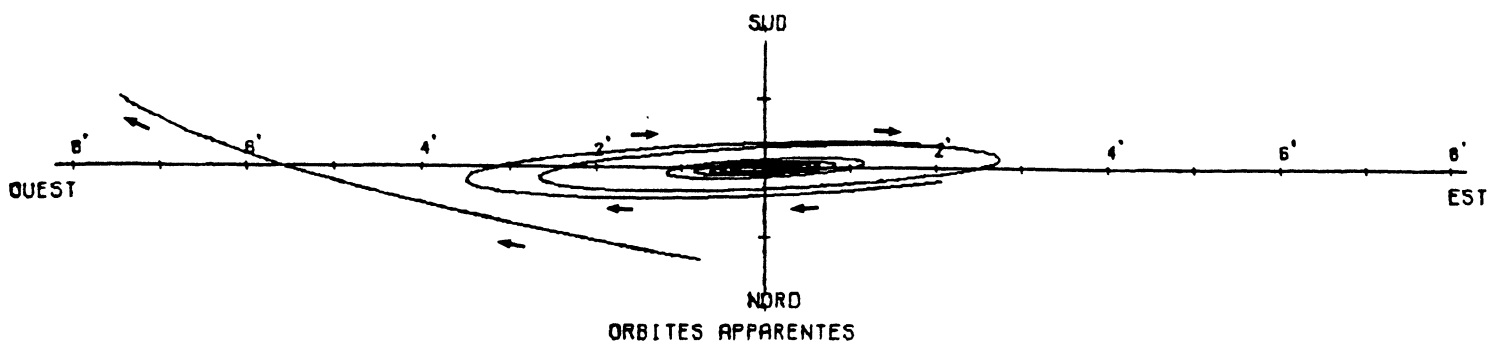

## 1997 .-CONFIGURATIONS DES SATELLITES DE SATURNE

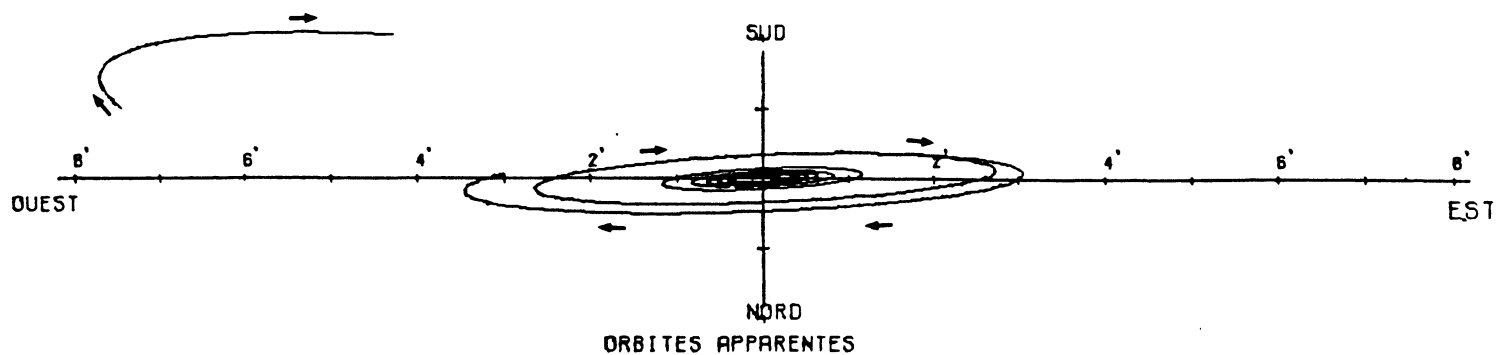
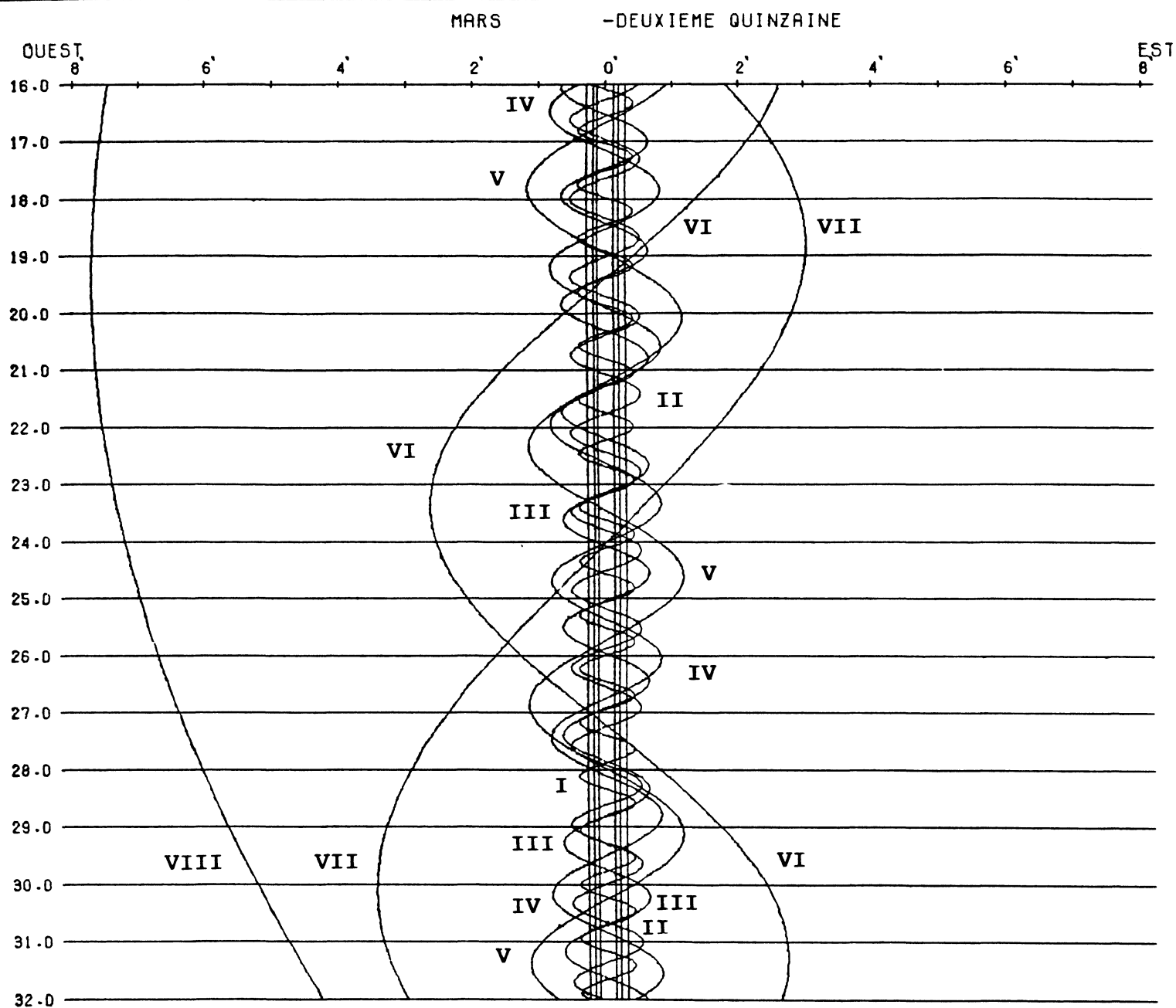

1997.-CONFIGURATIONS DES SATELLITES DE SATURNE

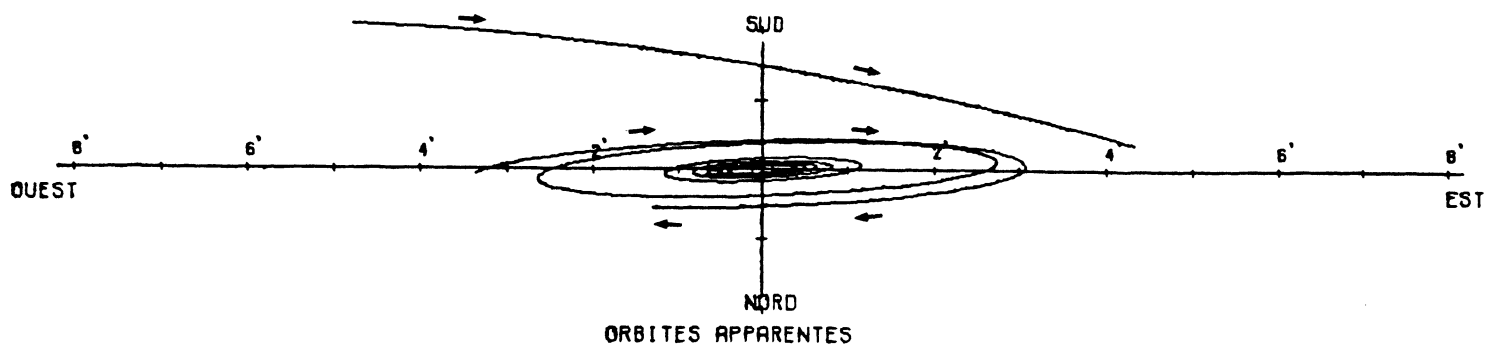
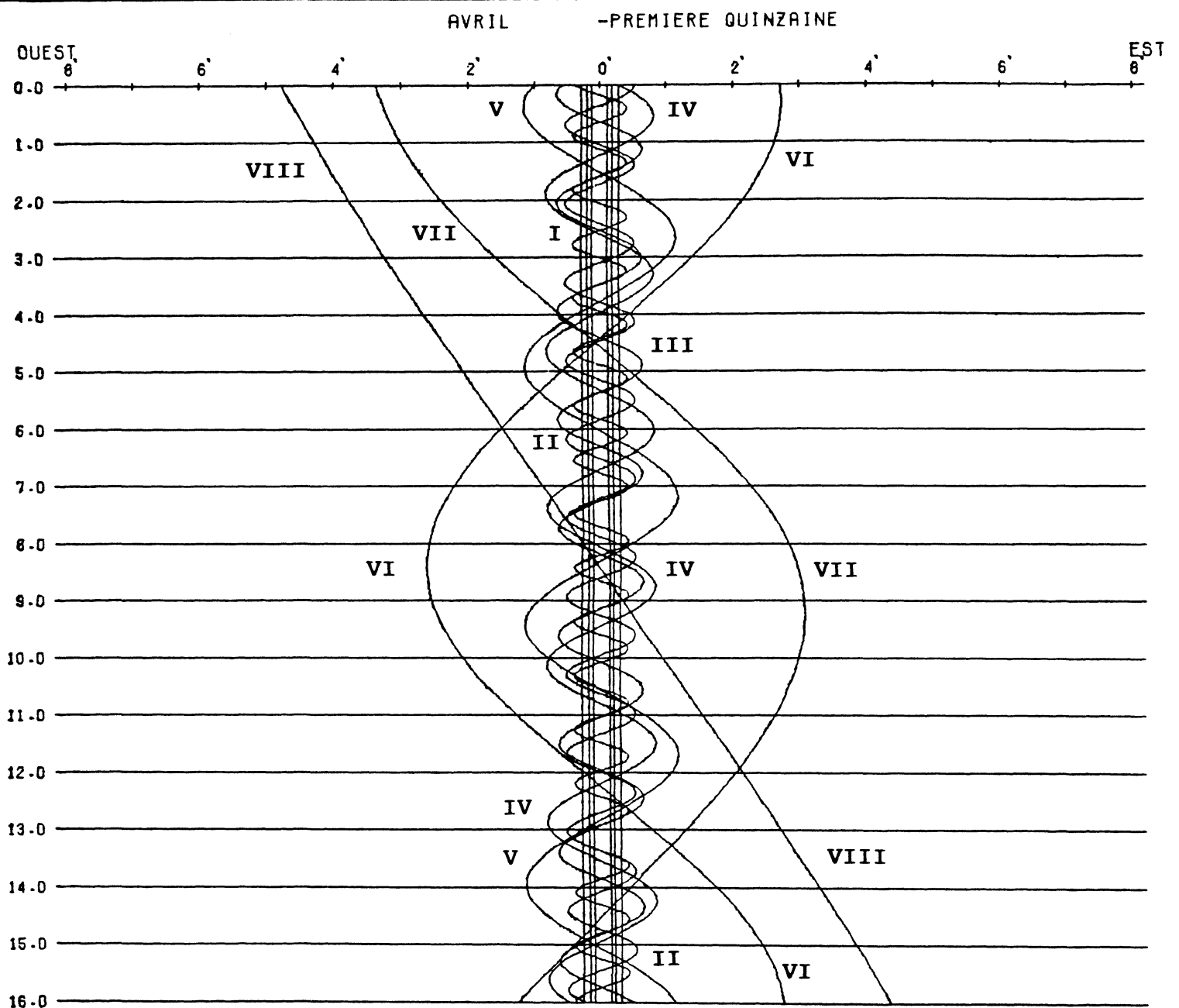

1997 .-CONFIGURATIONS DES SATELLITES DE SATURNE

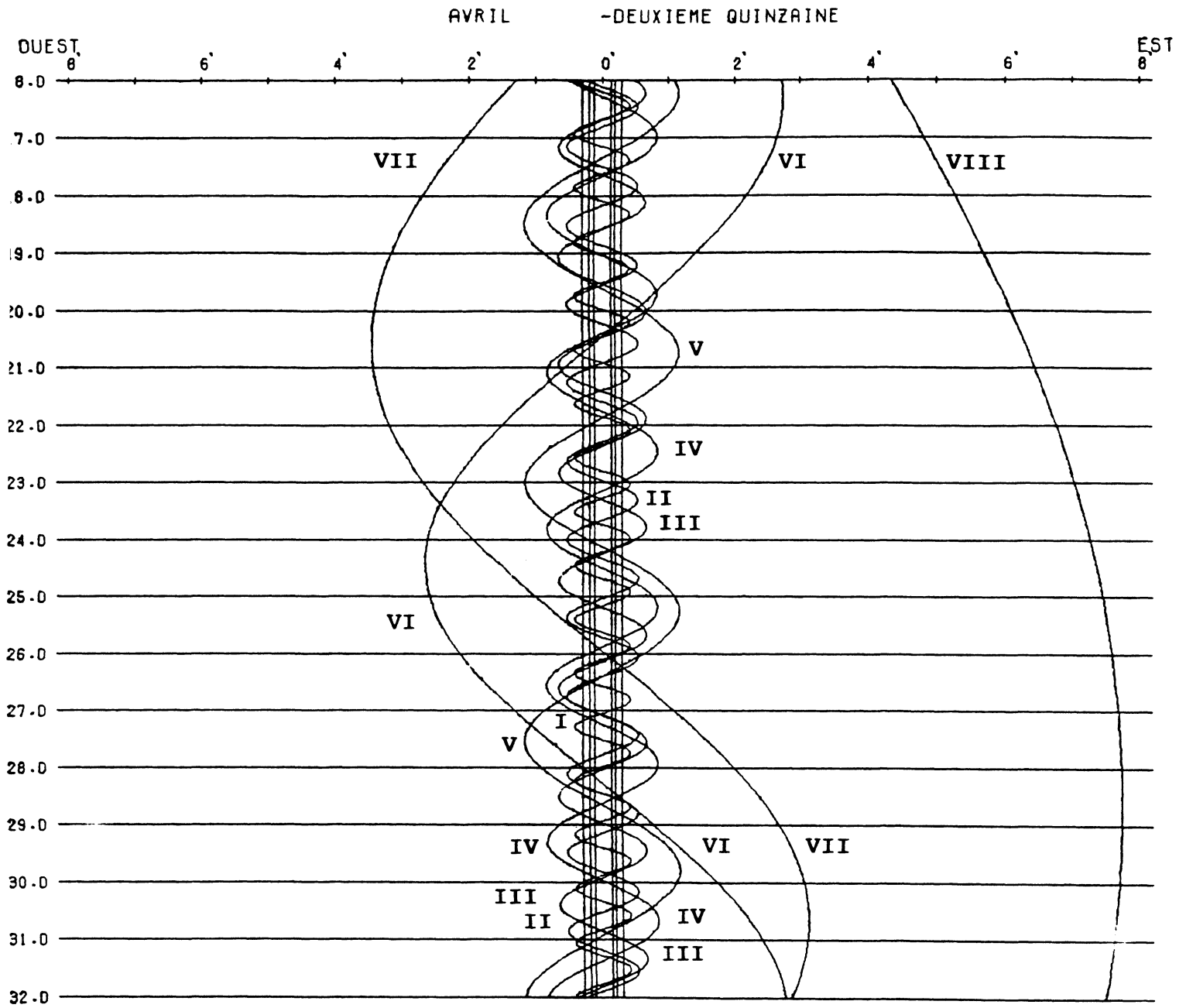

DANS LE SENS OUEST-EST, LES SATELLITES PASSENT AU-DELA DE SATURNE

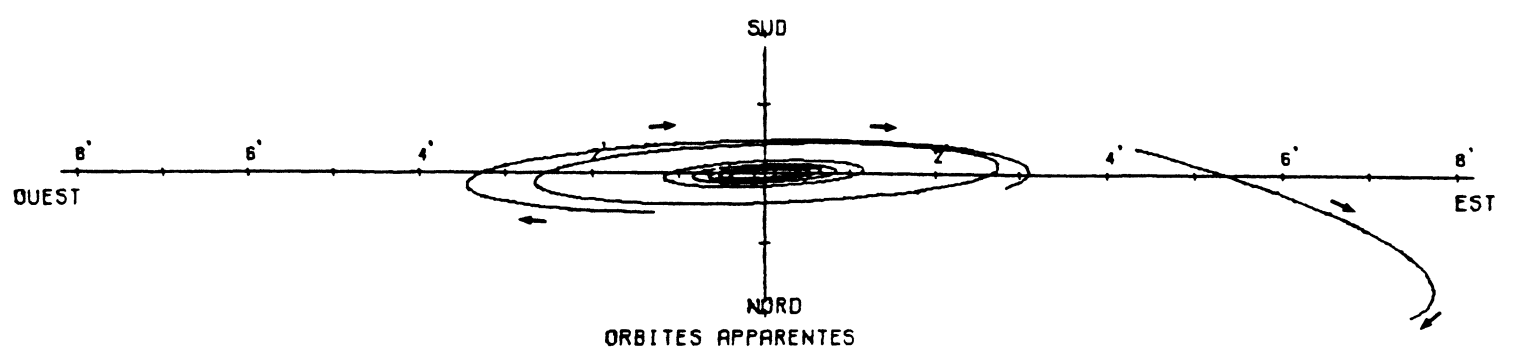

1997 .-CONFIGURATIONS DES SATELLITES DE SATURNE

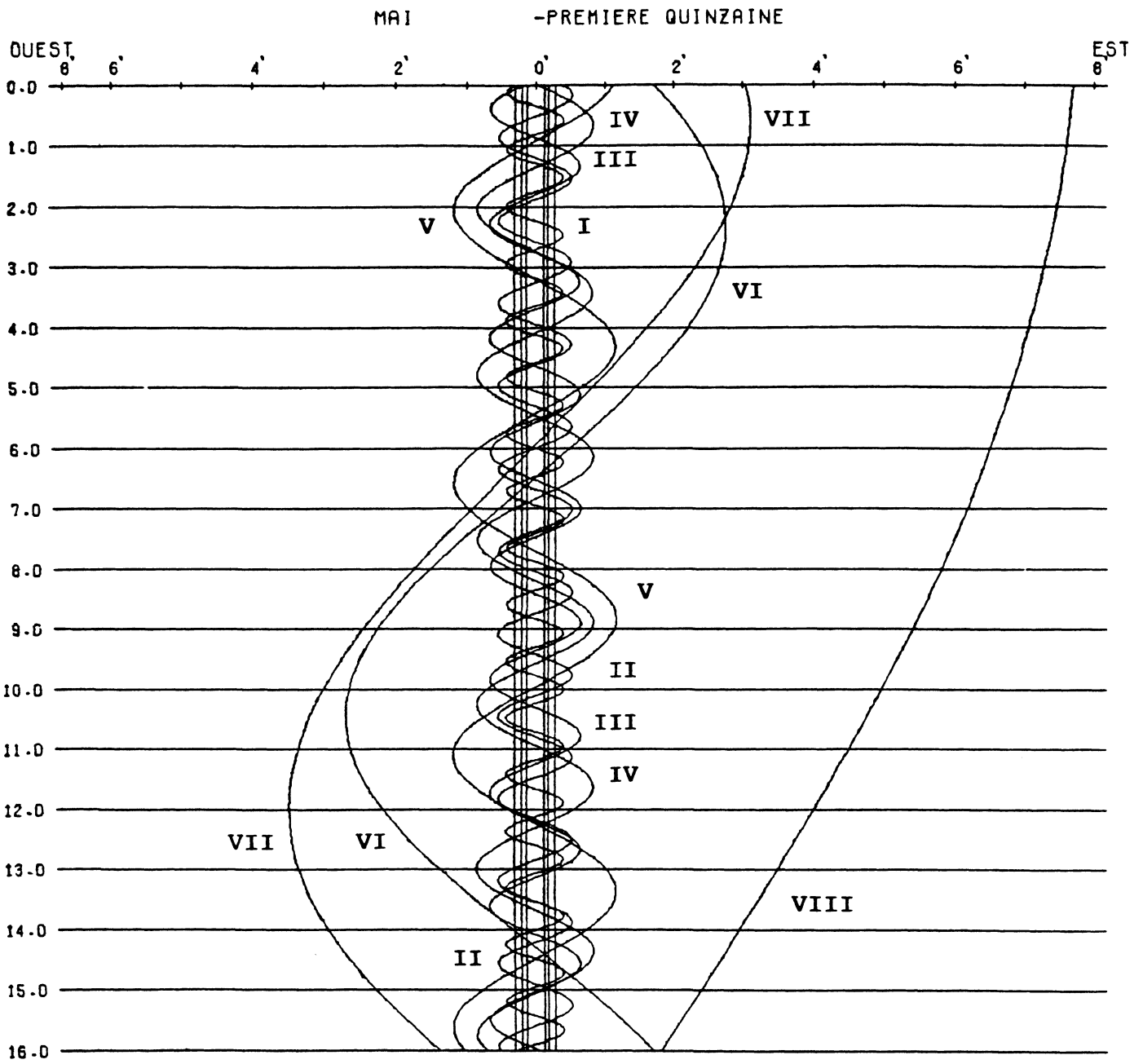

DANS LE SENS OUEST-EST, LES SATELLITES PASSENT AU-DELA DE SATURNE

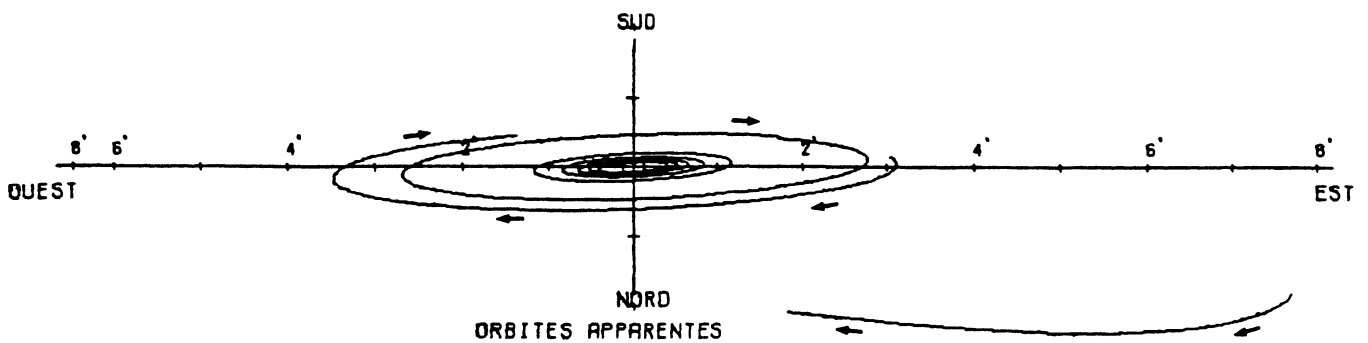

1997 .-CONFIGURATIONS DES SATELLITES DE SATURNE

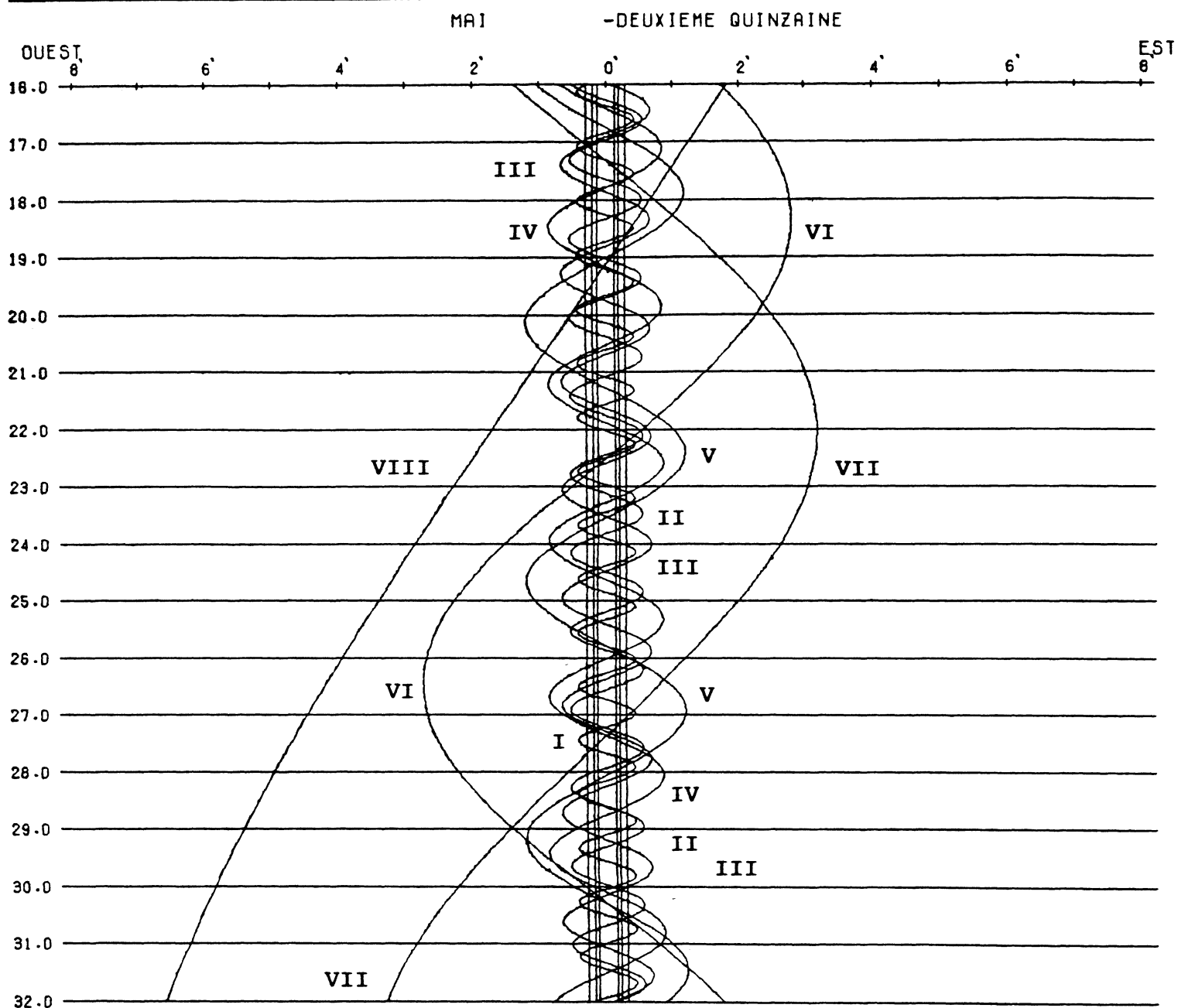

DANS LE SENS OUEST-EST, LES SATELLITES PASSENT AU-DELA DE SATURNE

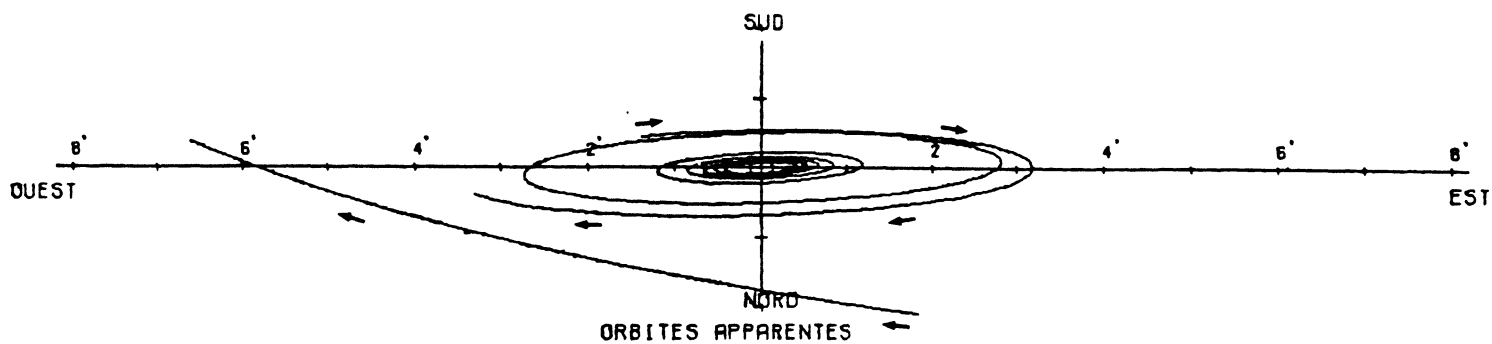

1997 .-CONFIGURATIONS DES SATELLITES DE SATURNE

JUIN -PREMIERE QUINZAINE

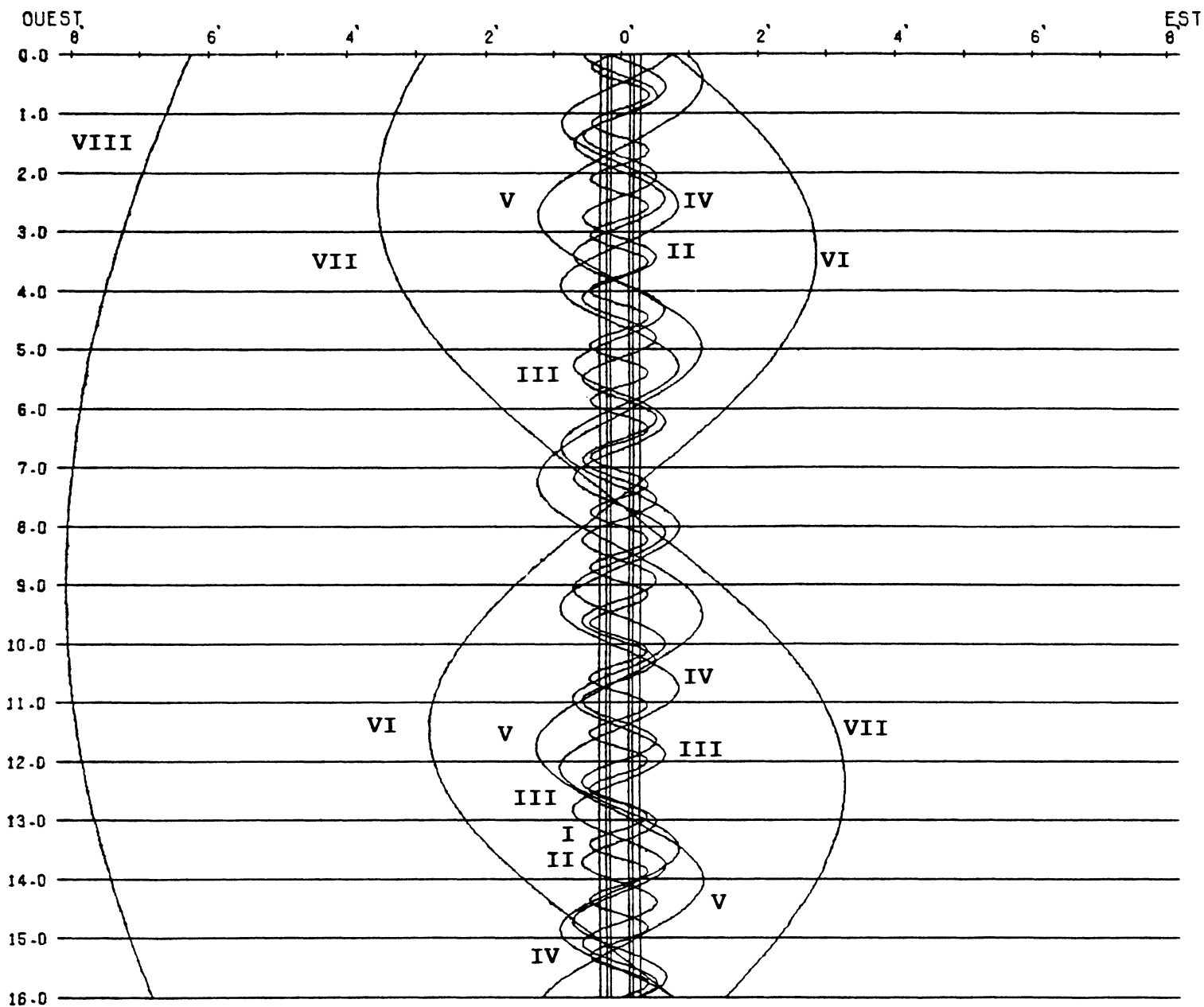

DANS LE SENS OUEST-EST, LES SATELLITES PASSENT AU-DELA DE SATURNE

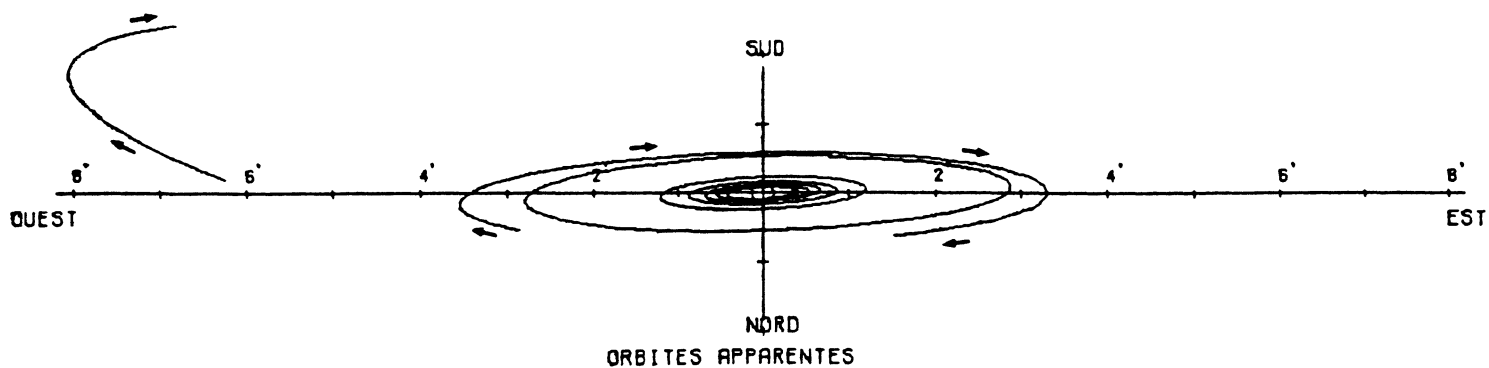

1997 .-CONFIGURATIONS DES SATELLITES DE SATURNE

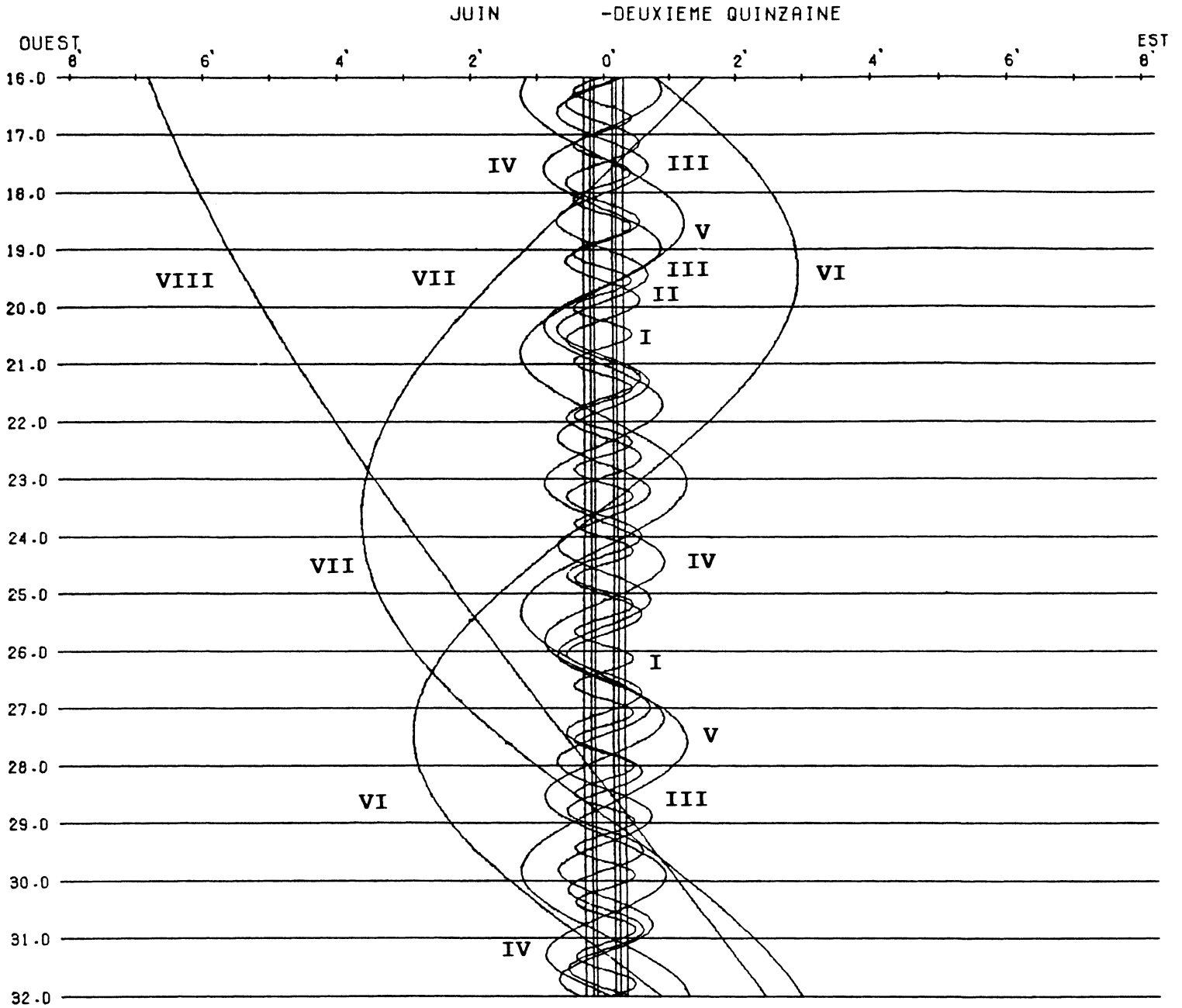

DANS LE SENS OUEST-EST, LES SATELLITES PASSENT AU-DELA DE SATURNE

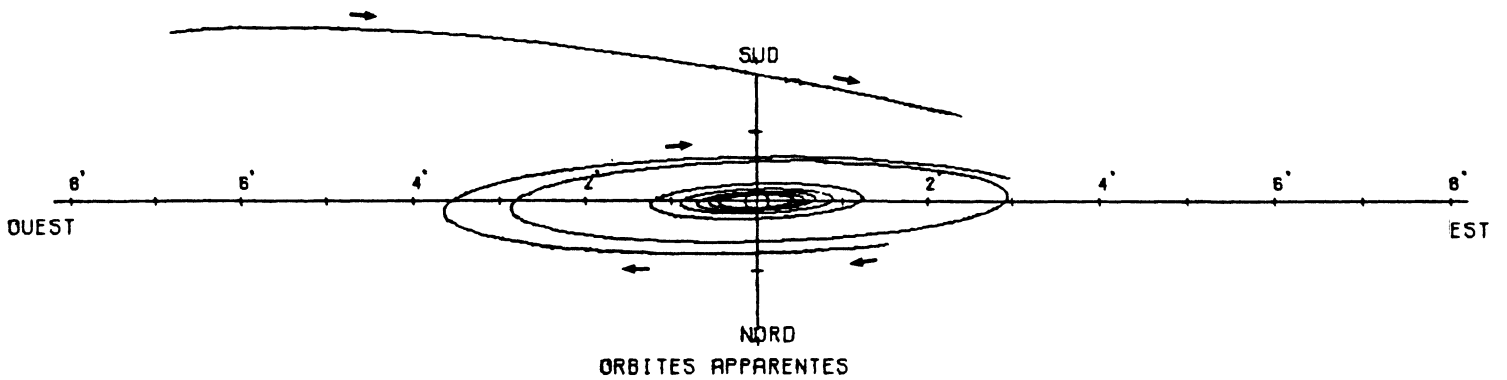



1997 .-CONFIGURATIONS DES SATELLITES DE SATURNE

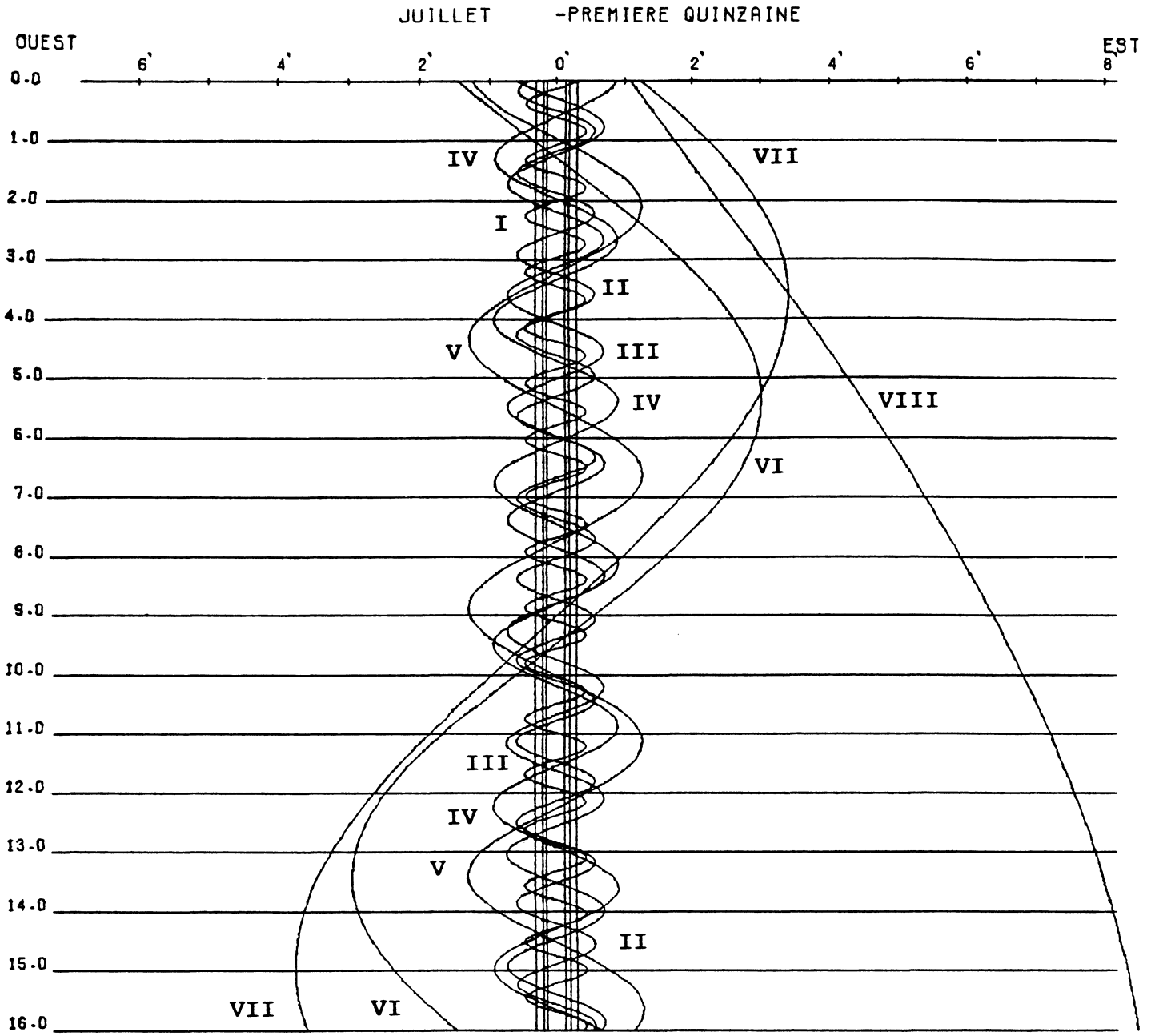

DANS LE SENS OUEST-EST, LES SATELLITES PASSENT AU-DELA DE SATURNE

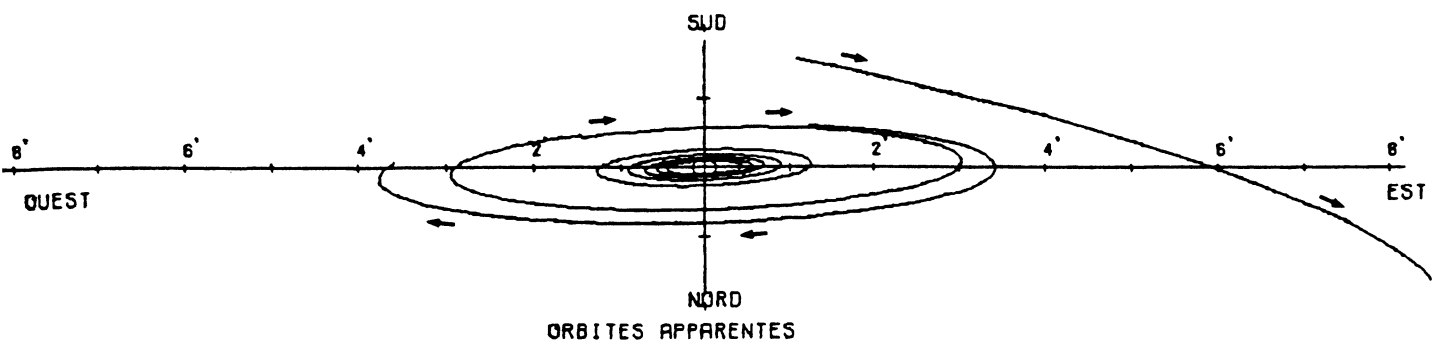

1997 .-CONFIGURATIONS DES SATELLITES DE SATURNE

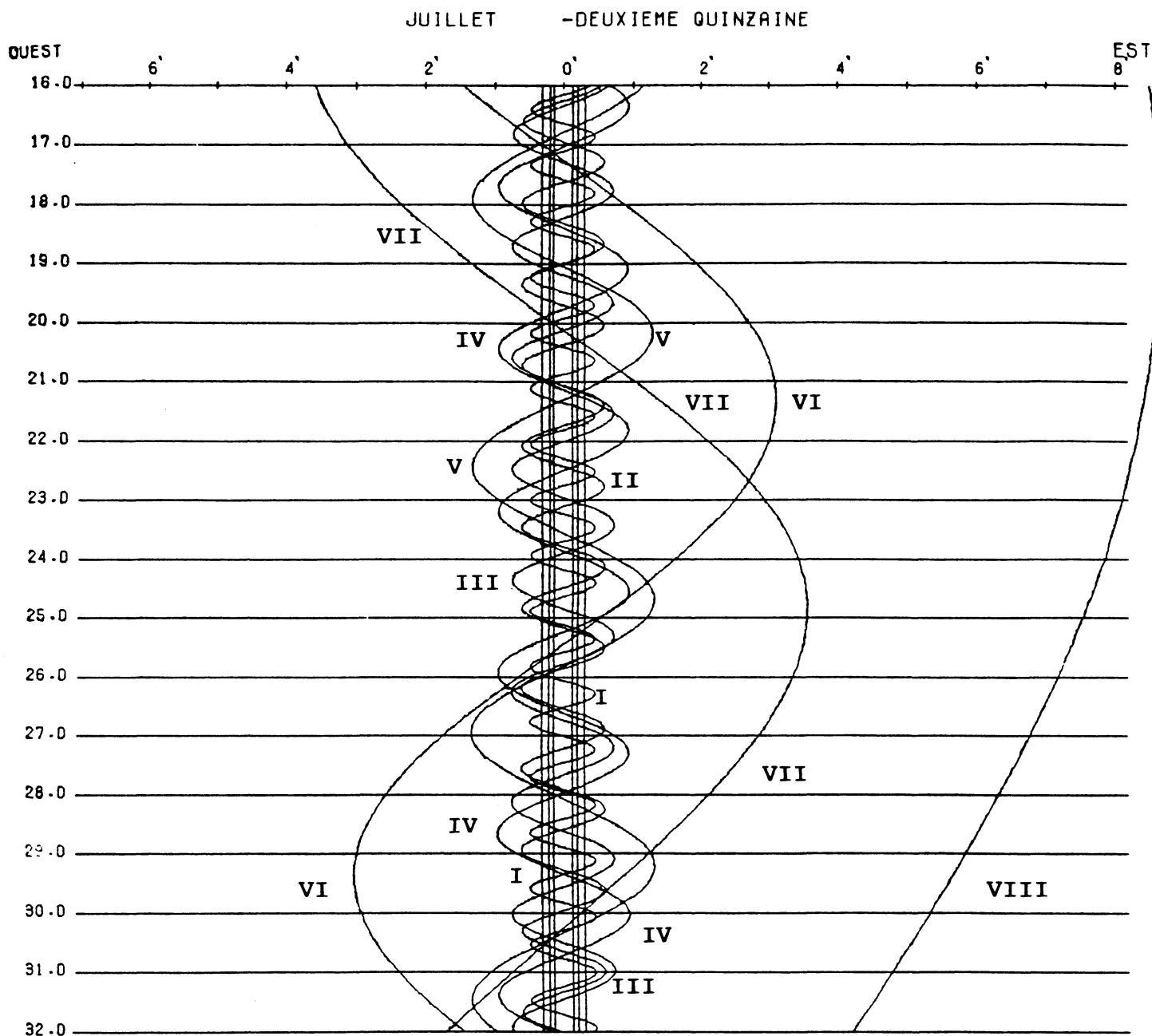

DANS LE SENS OUEST-EST. LES SATELLITES PASSES AU-DELA DE SATURNE

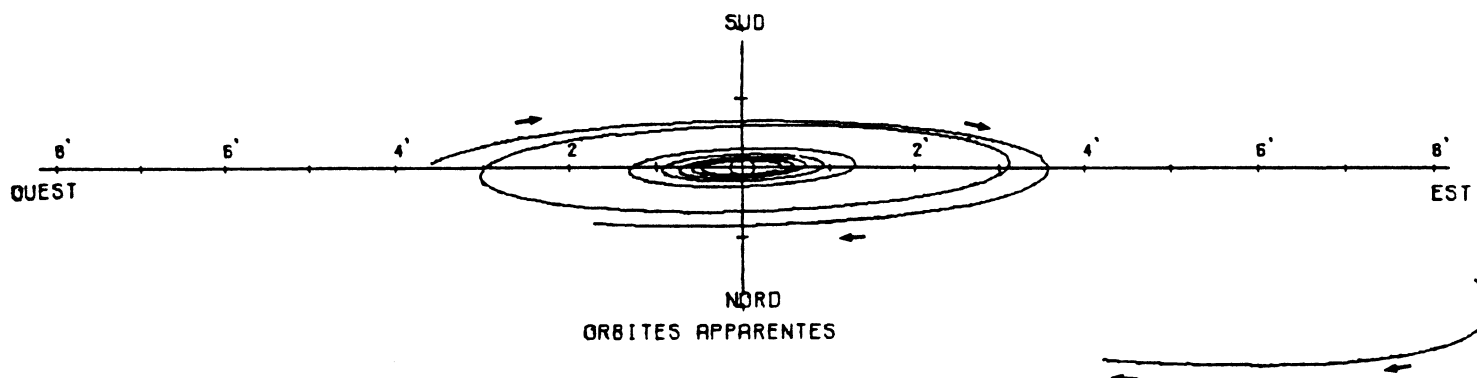

1997 .-CONFIGURATIONS DES SATELLITES DE SATURNE

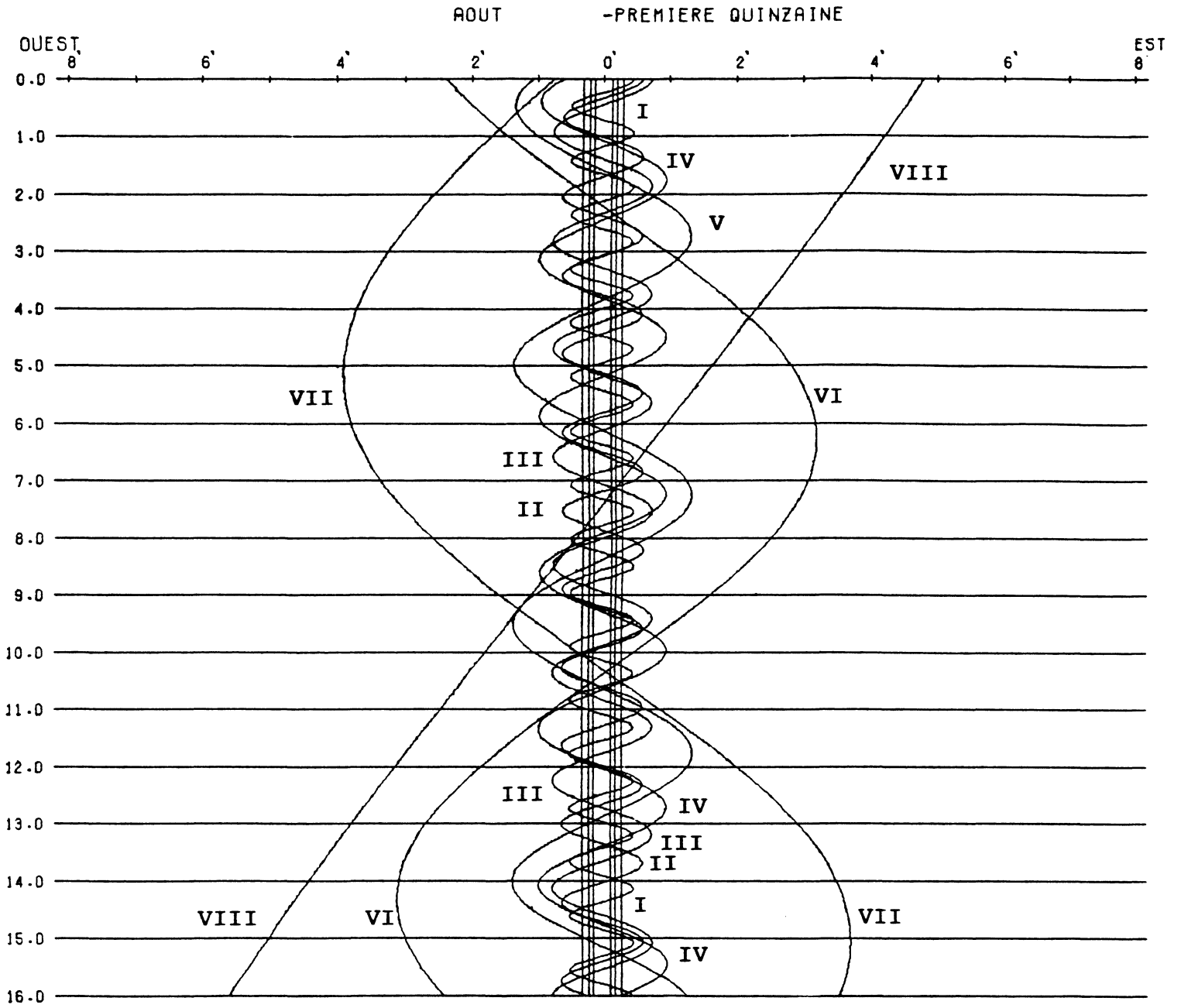

DANS LE SENS OUEST-EST. LES SATELLITES PASSENT AU-DELA DE SATURNE

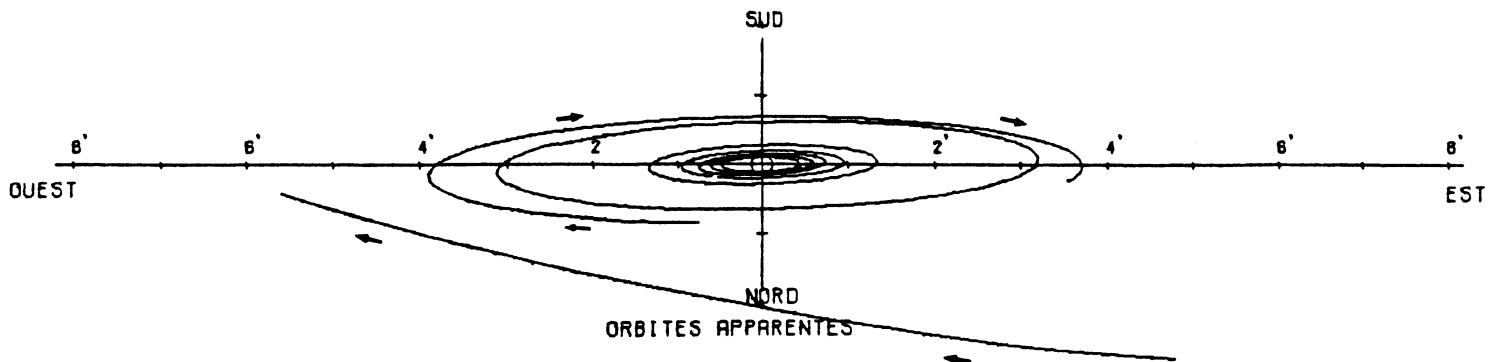

1997 .-CONFIGURATIONS DES SATELLITES DE SATURNE

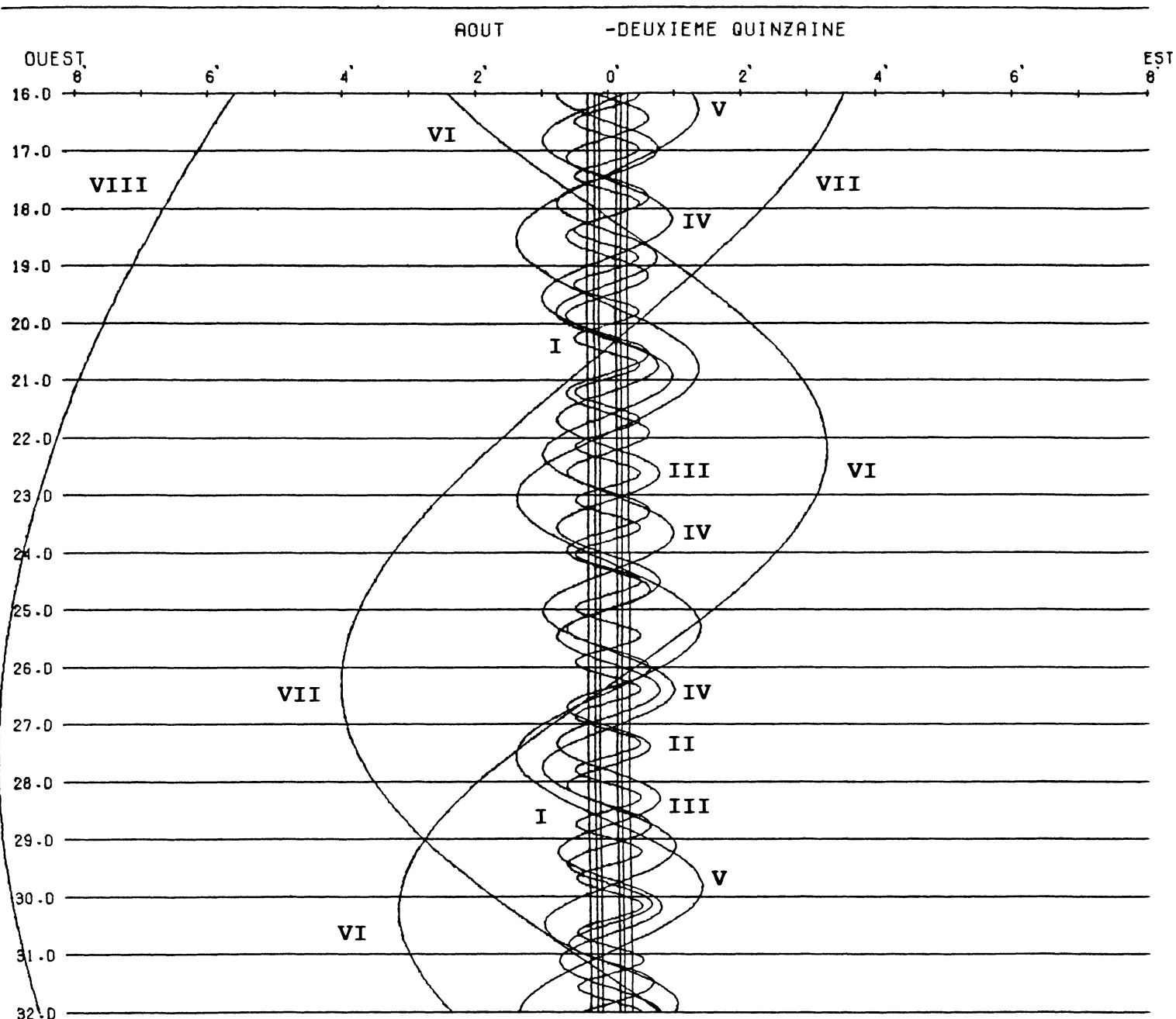

DANS LE SENS OUEST-EST. LES SATELLITES PASSENT AU-DELA DE SATURNE

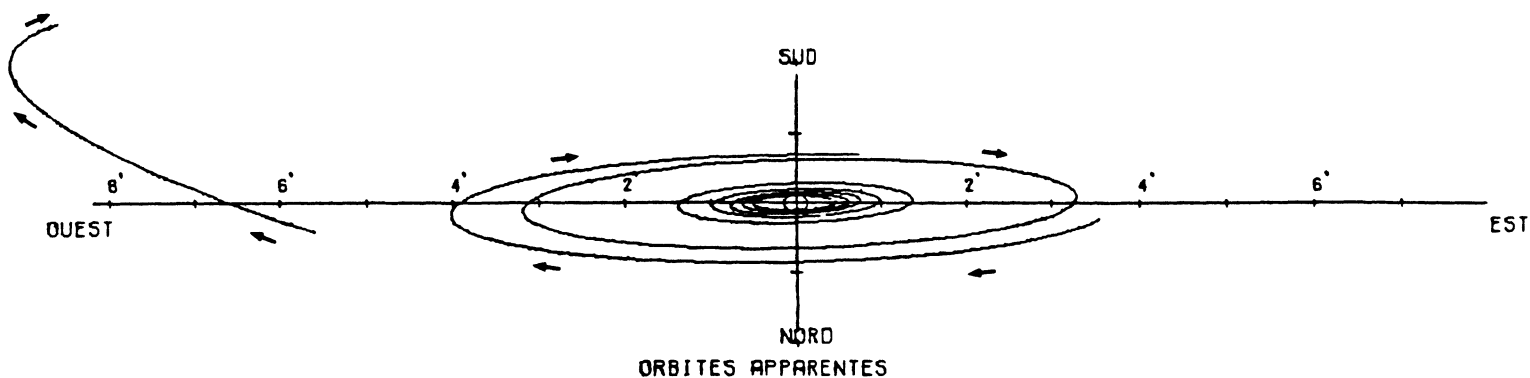

1997 .-CONFIGURATIONS DES SATELLITES DE SATURNE

SEPTEMBRE -PREMIERE QUINZAINE

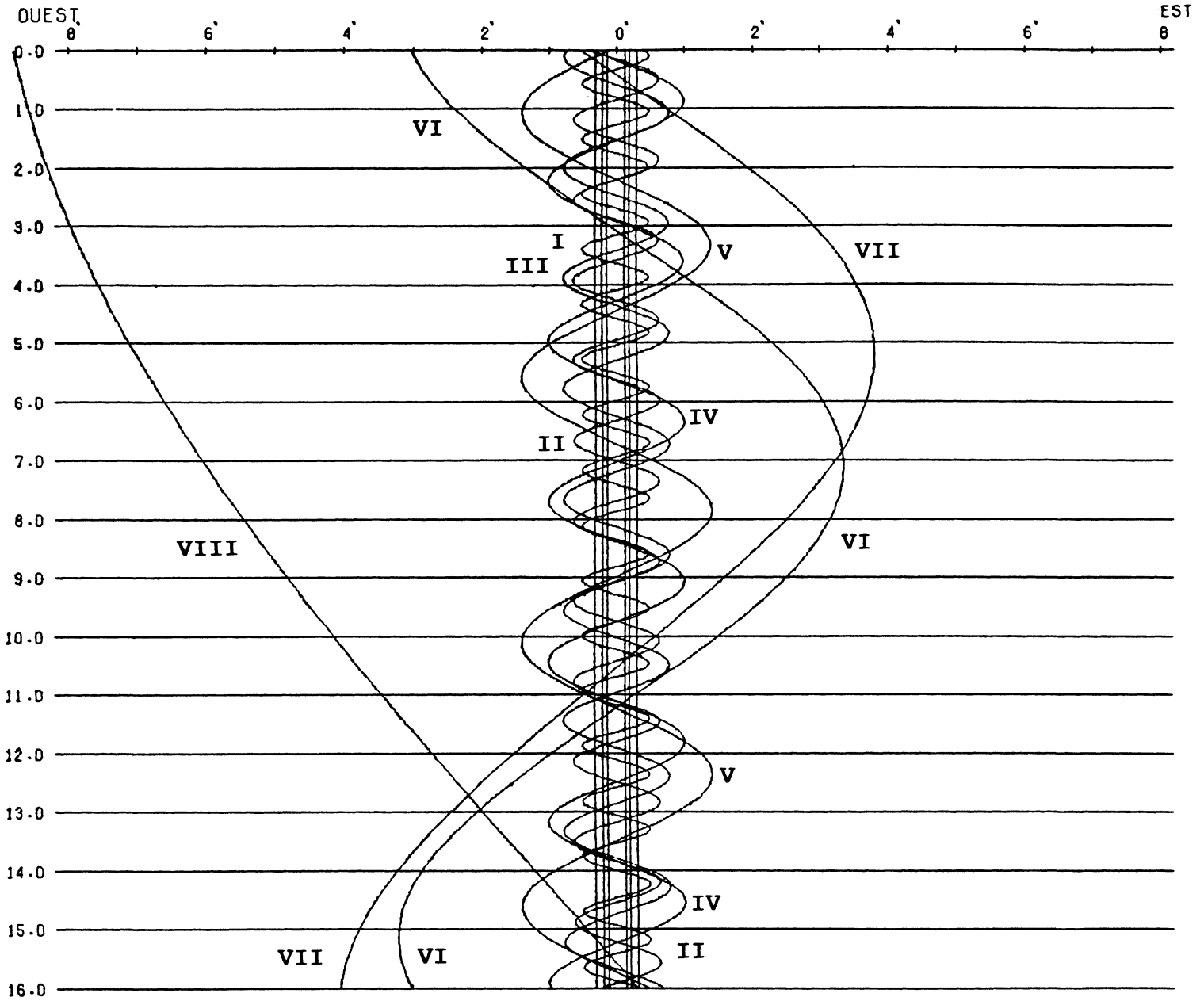

DANS LE SENS OUEST-EST, LES SATELLITES PASSENT AU-DELA DE SATURNE

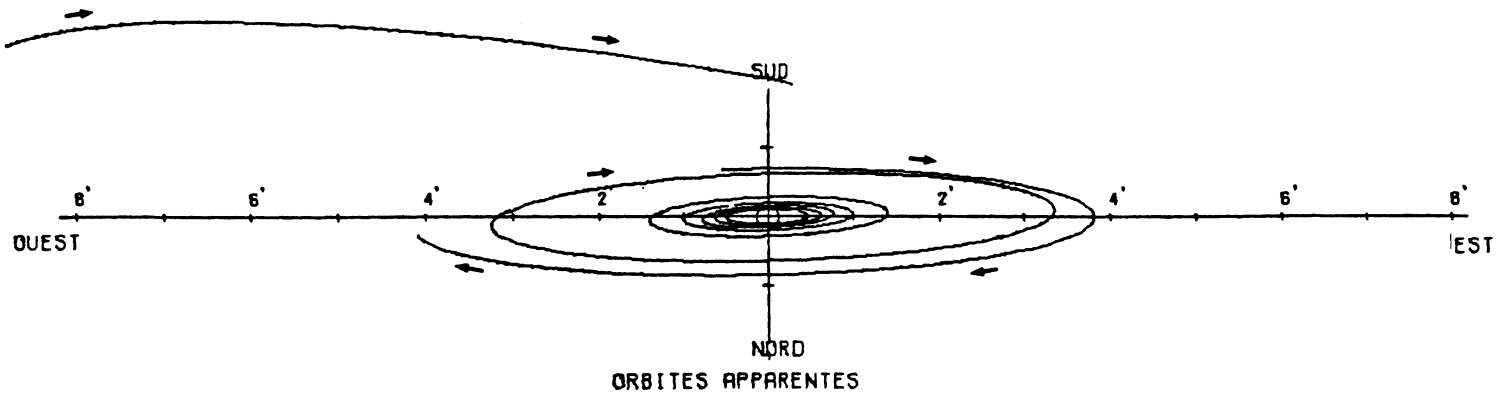

1997 .-CONFIGURATIONS DES SATELLITES DE SATURNE

SEPTEMBRE -DEUXIEME QUINZAIN

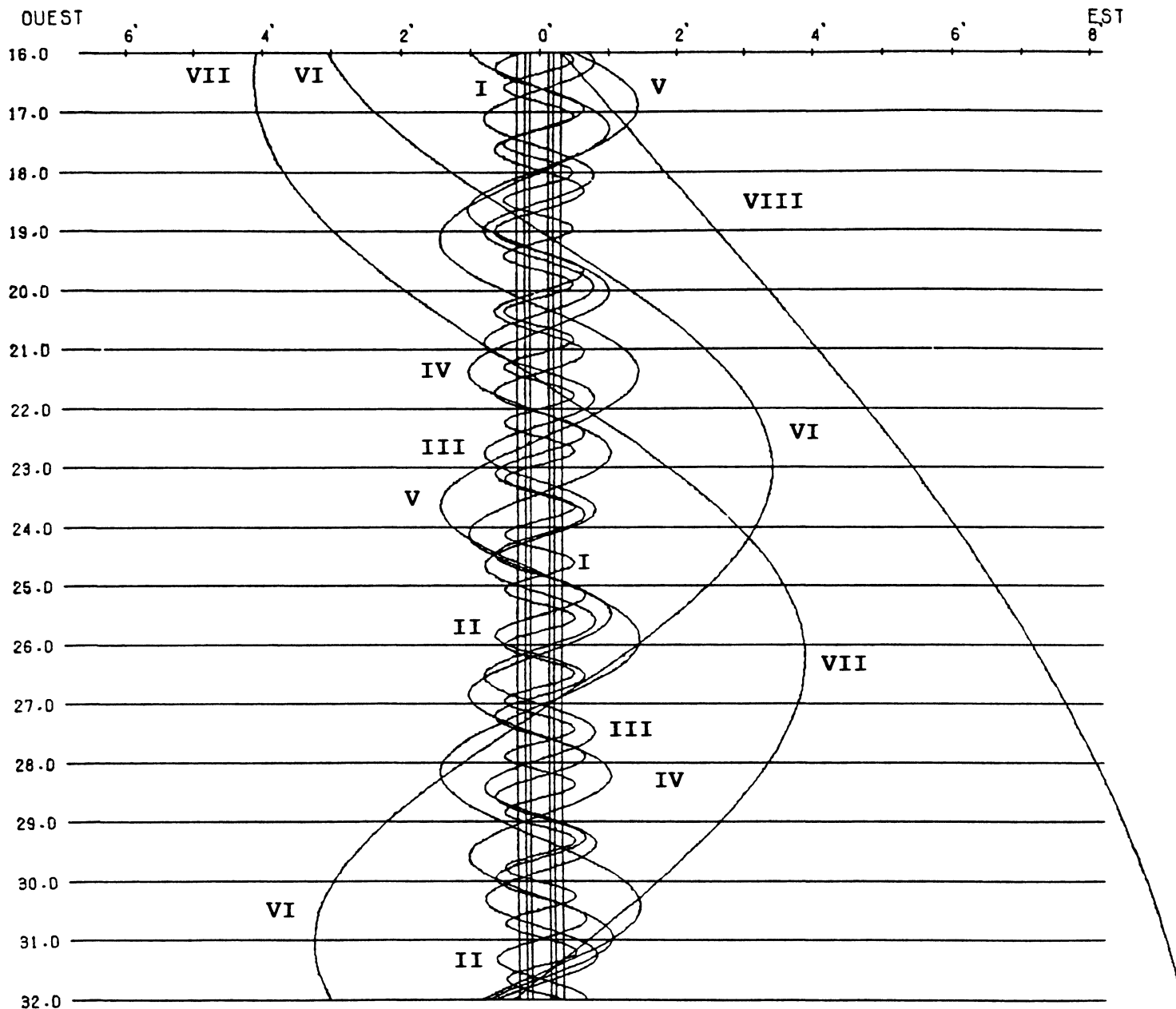

DANS LE SENS OUEST-EST.LES SATELLITES PASSENT AU-DELA DE SATURNE

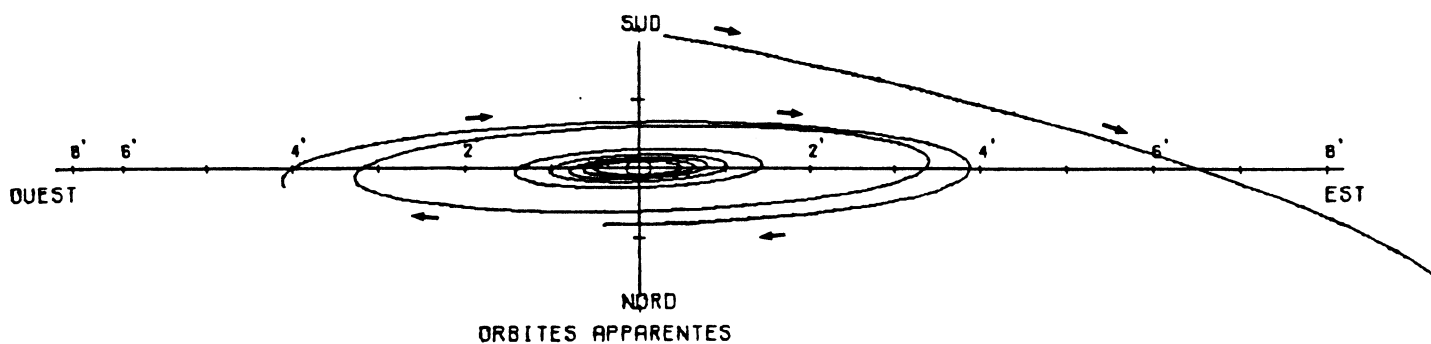

1997 .-CONFIGURATIONS DES SATELLITES DE SATURNE

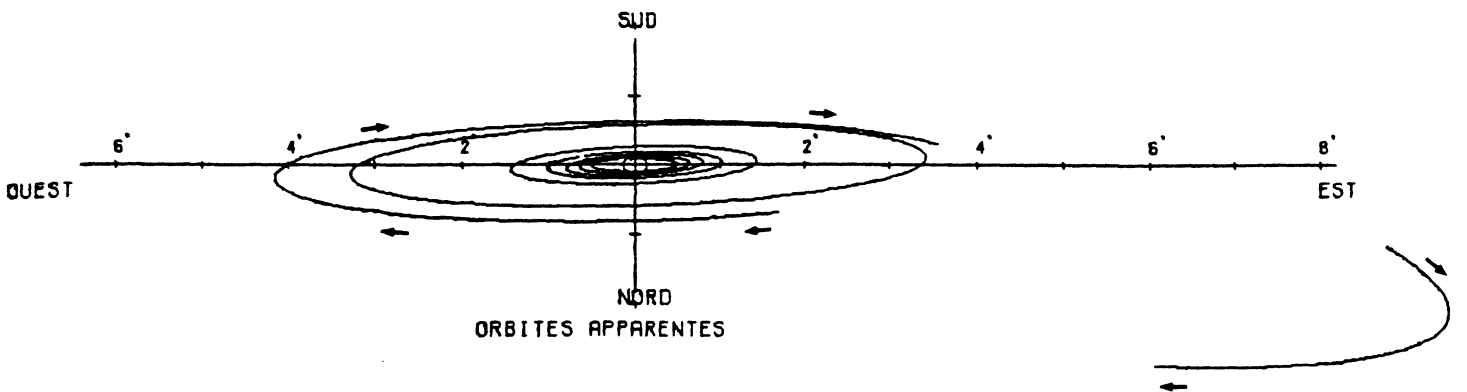
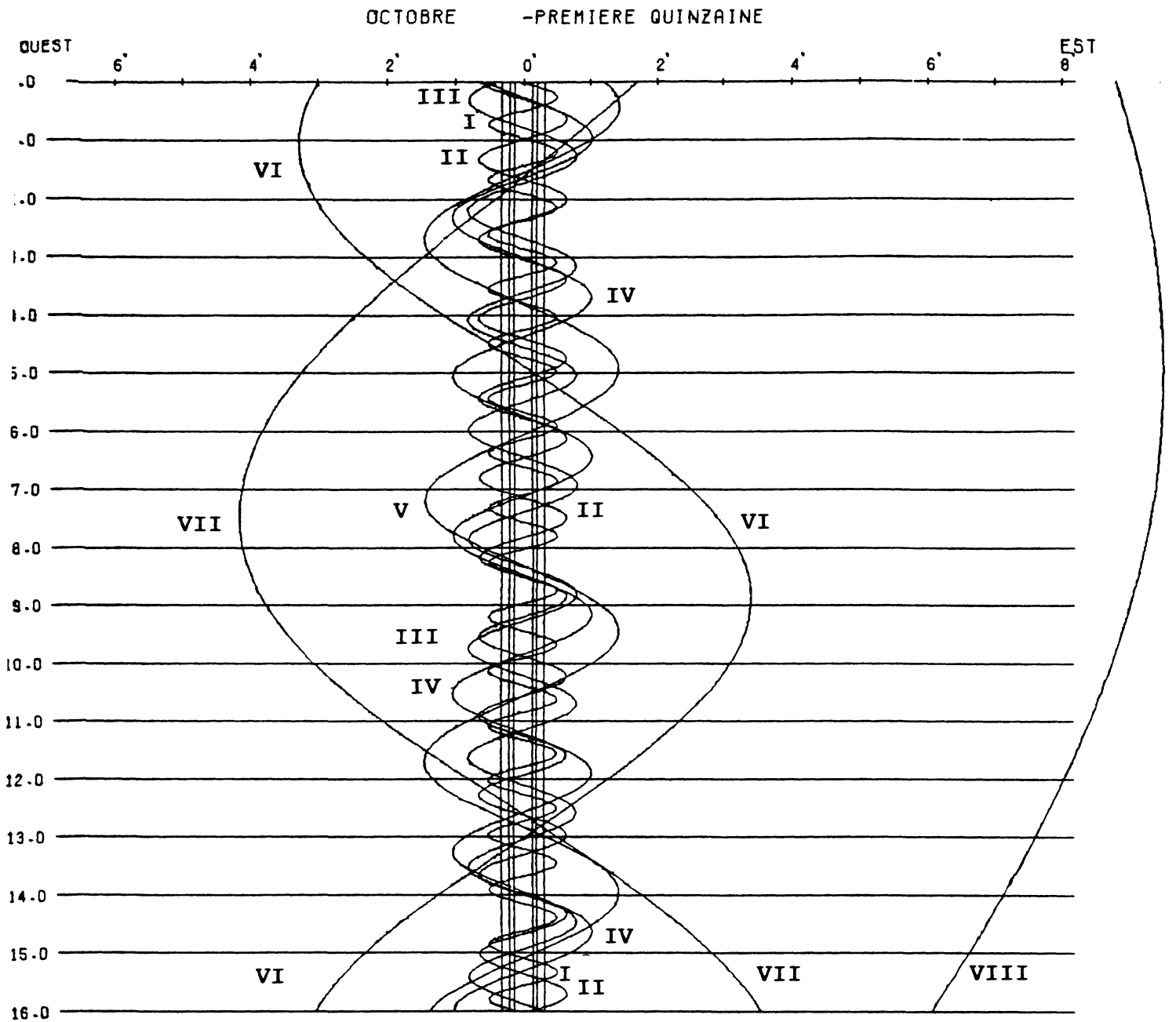

1997 .-CONFIGURATIONS DES SATELLITES DE SATURNE

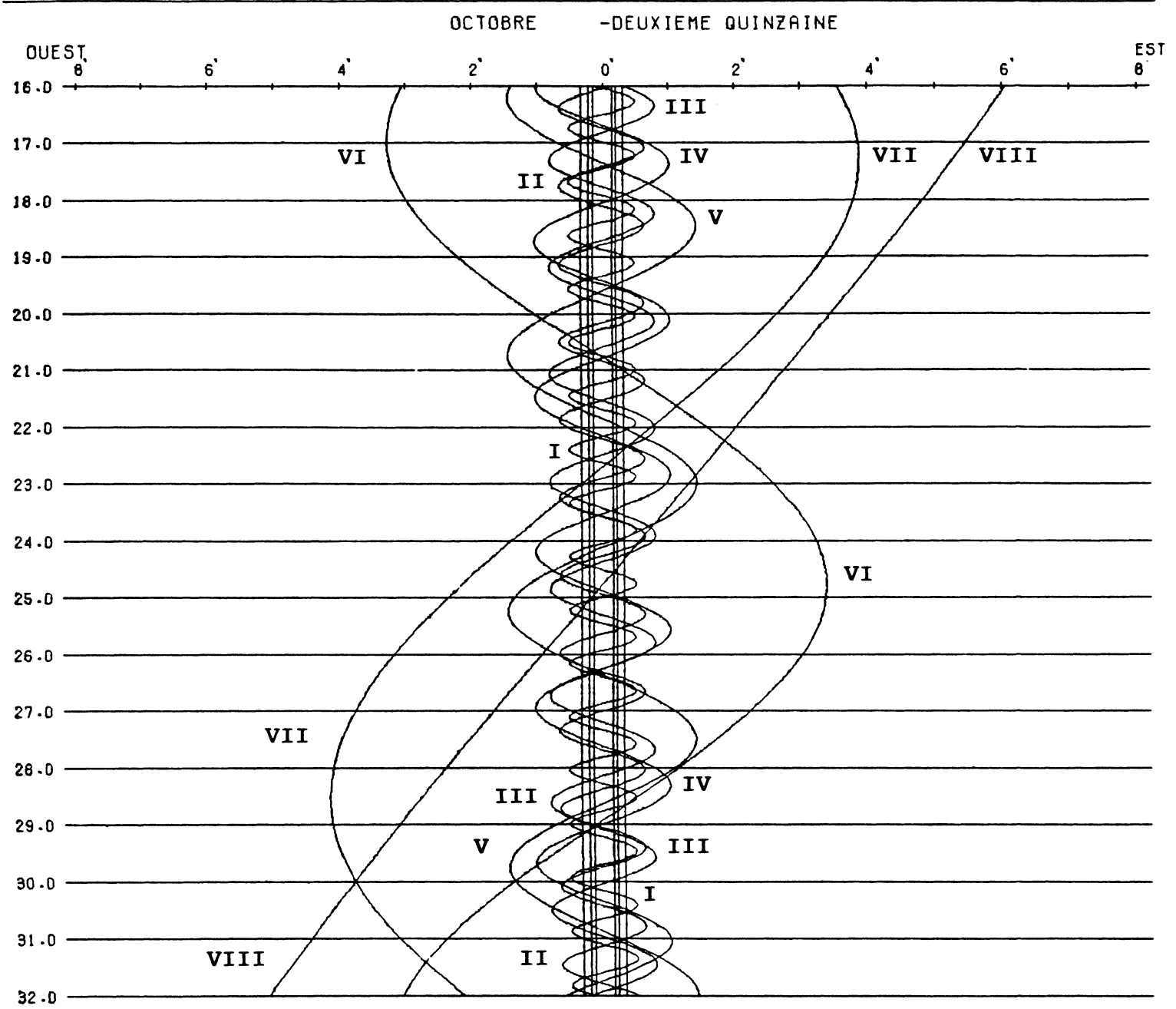

DANS LE SENS OUEST-EST, LES SATELLITES PASSENT AU-DELA DE SATURNE

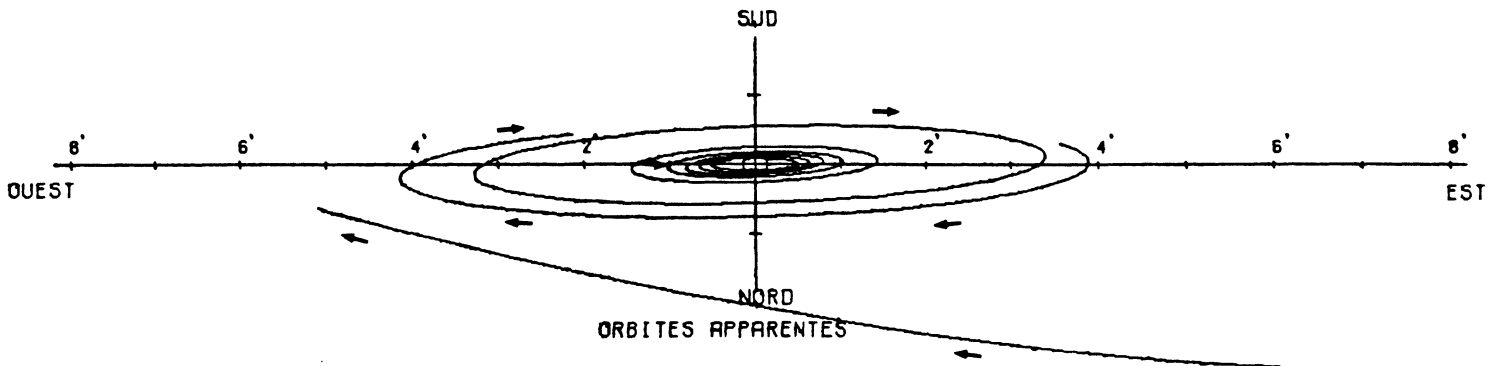



1997 .-CONFIGURATIONS DES SATELLITES DE SATURNE

NOVEMBRE -PREMIERE QUINZAINE

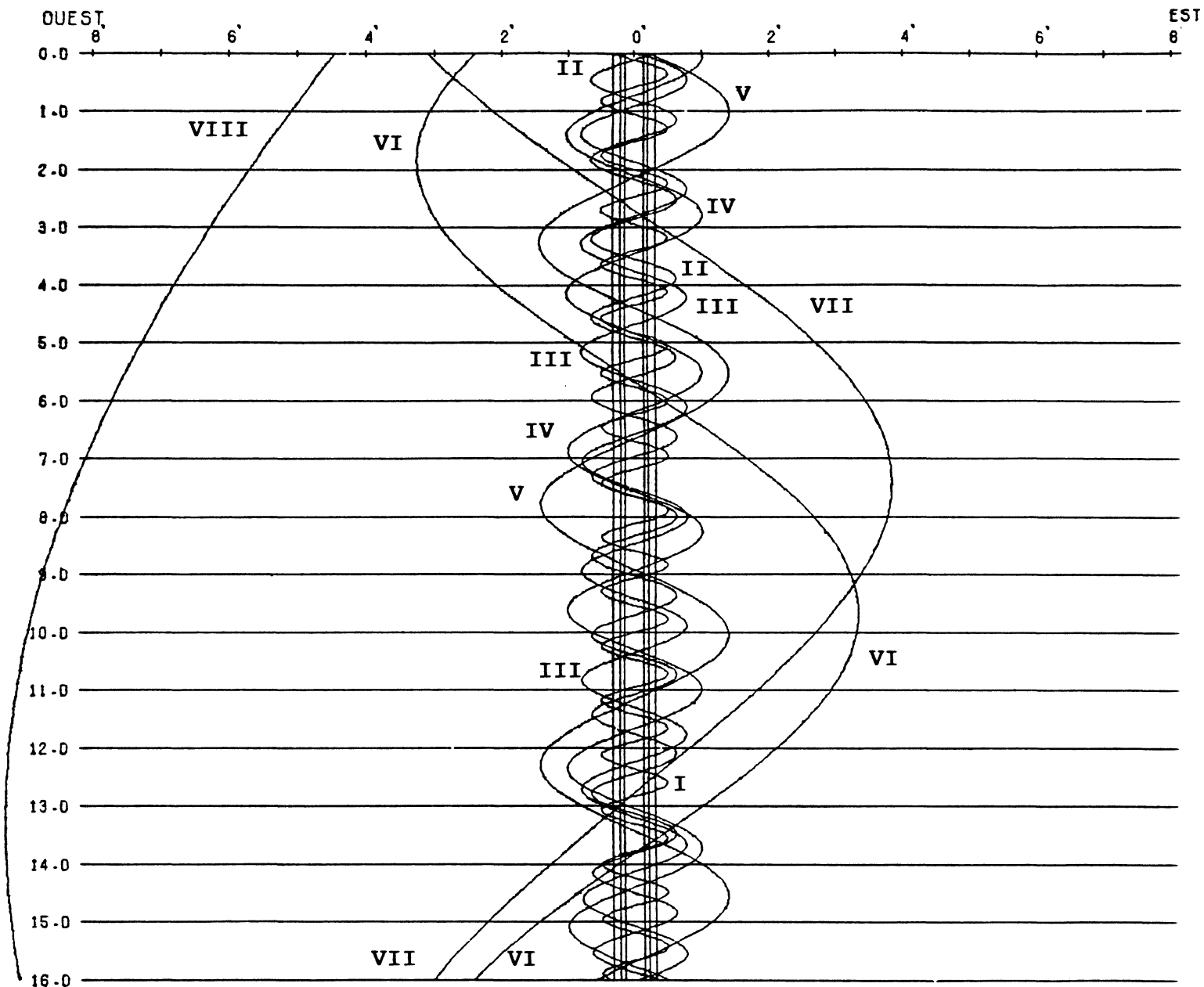

DANS LE SENS OUEST-EST.LES SATELLITES PASSENT AU-DELA DE SATURNE

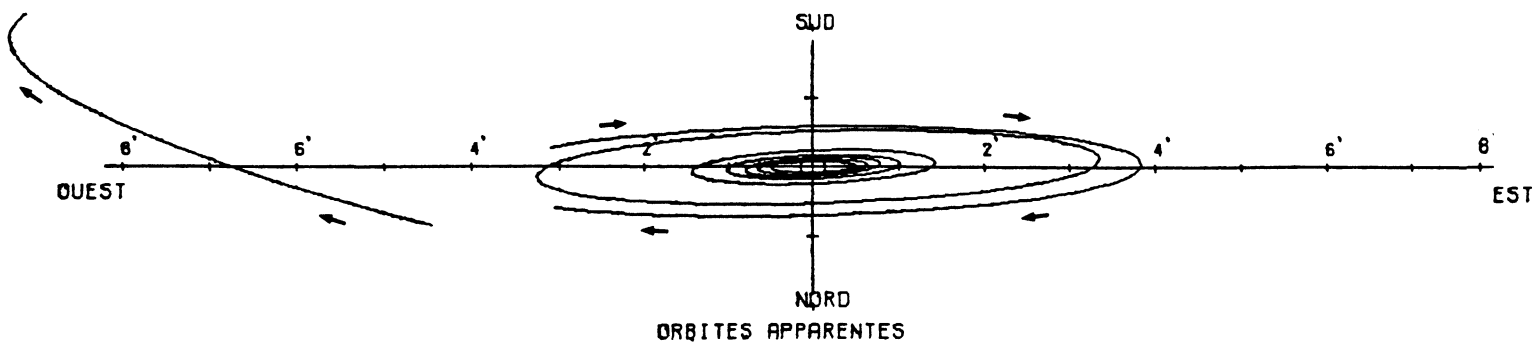

1997 .-CONFIGURATIONS DES SATELLITES DE SATURNE

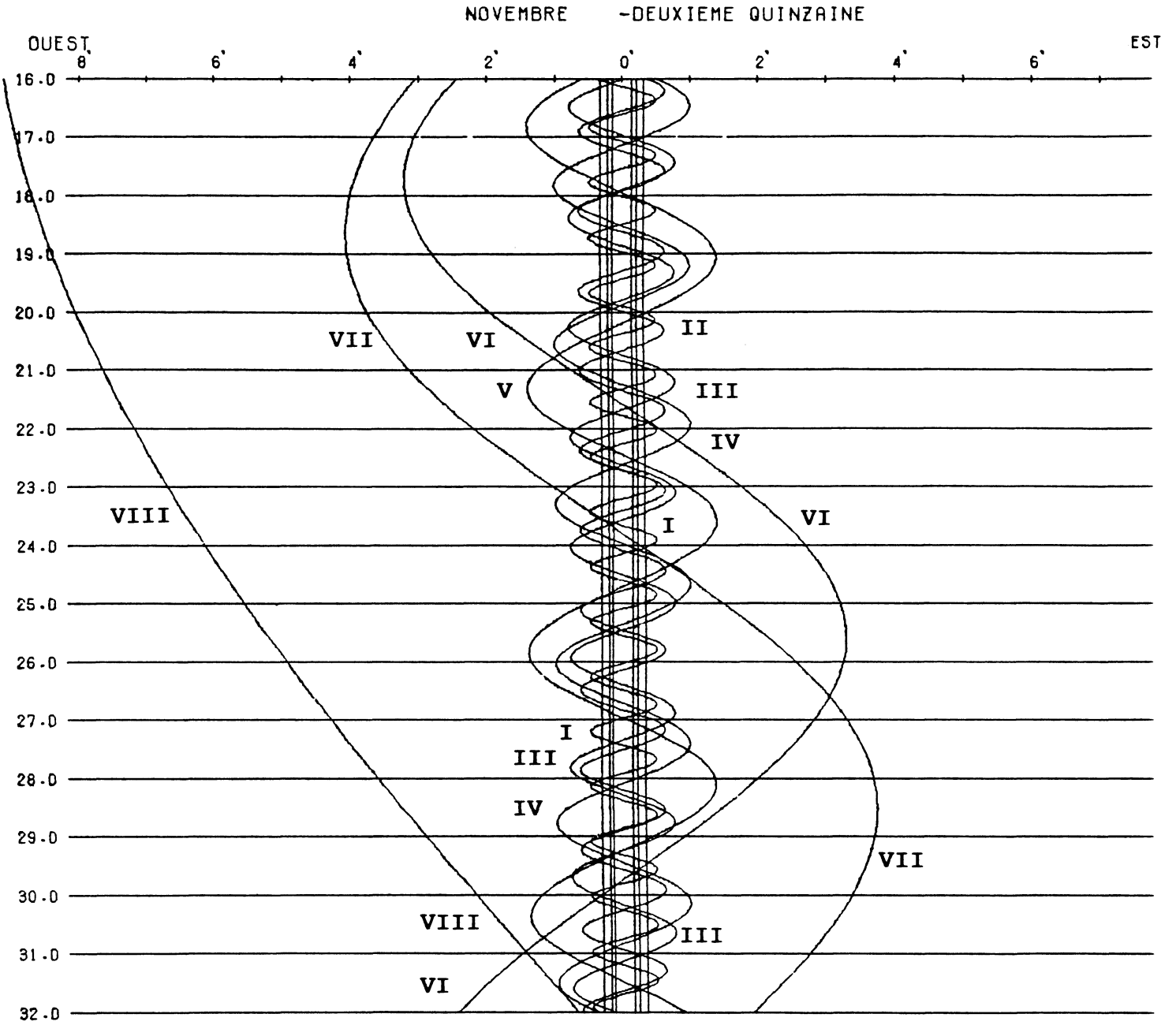

DANS LE SENS OUEST-EST, LES SATELLITES PASSENT AU-DELA DE SATURNE

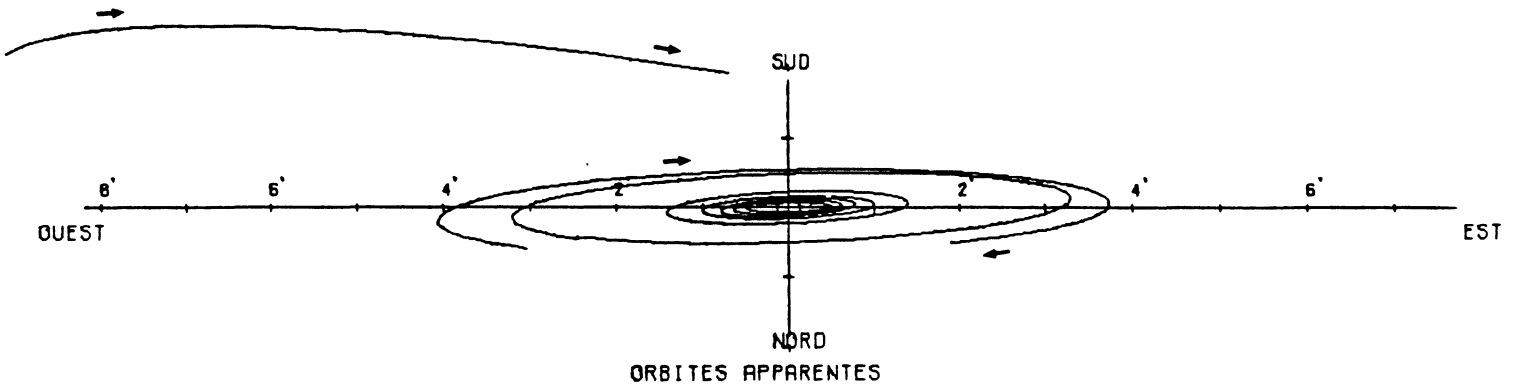

1997 .-CONFIGURATIONS DES SATELLITES DE SATURNE

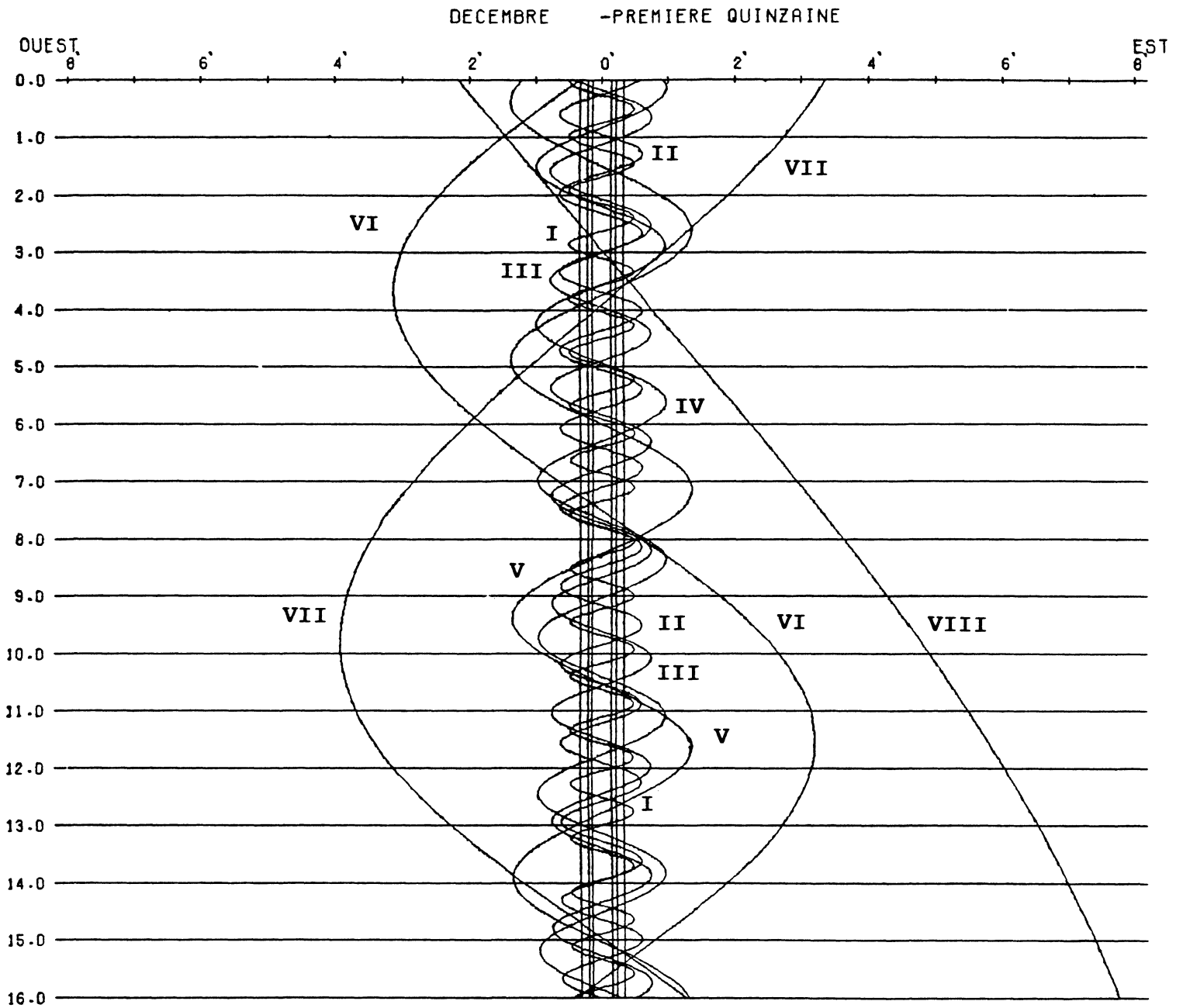

DANS LE SENS OUEST-EST, LES SATELLITES PASSENT AU-DELA DE SATURNE

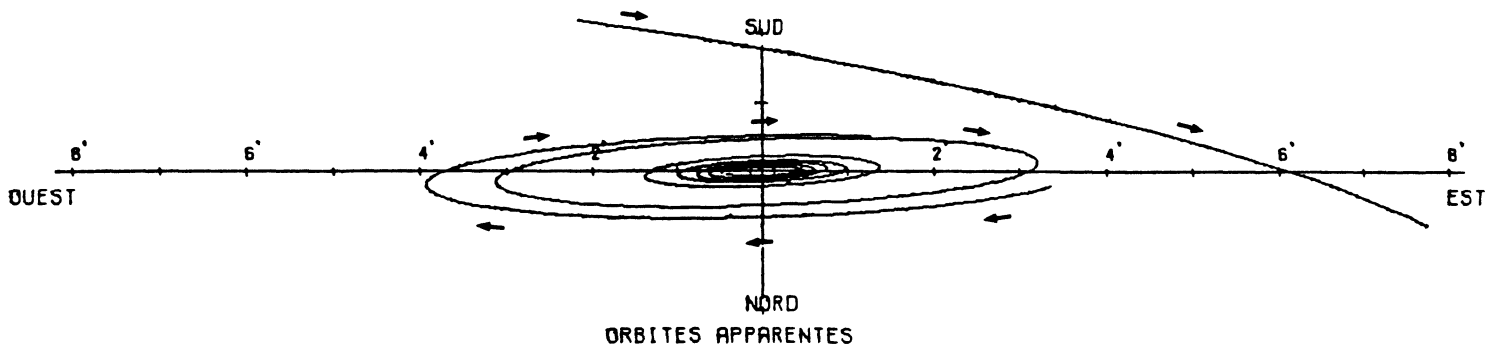

1997 .-CONFIGURATIONS DES SATELLITES DE SATURNE

DECEMBRE -DEUXIEME QUINZAINE

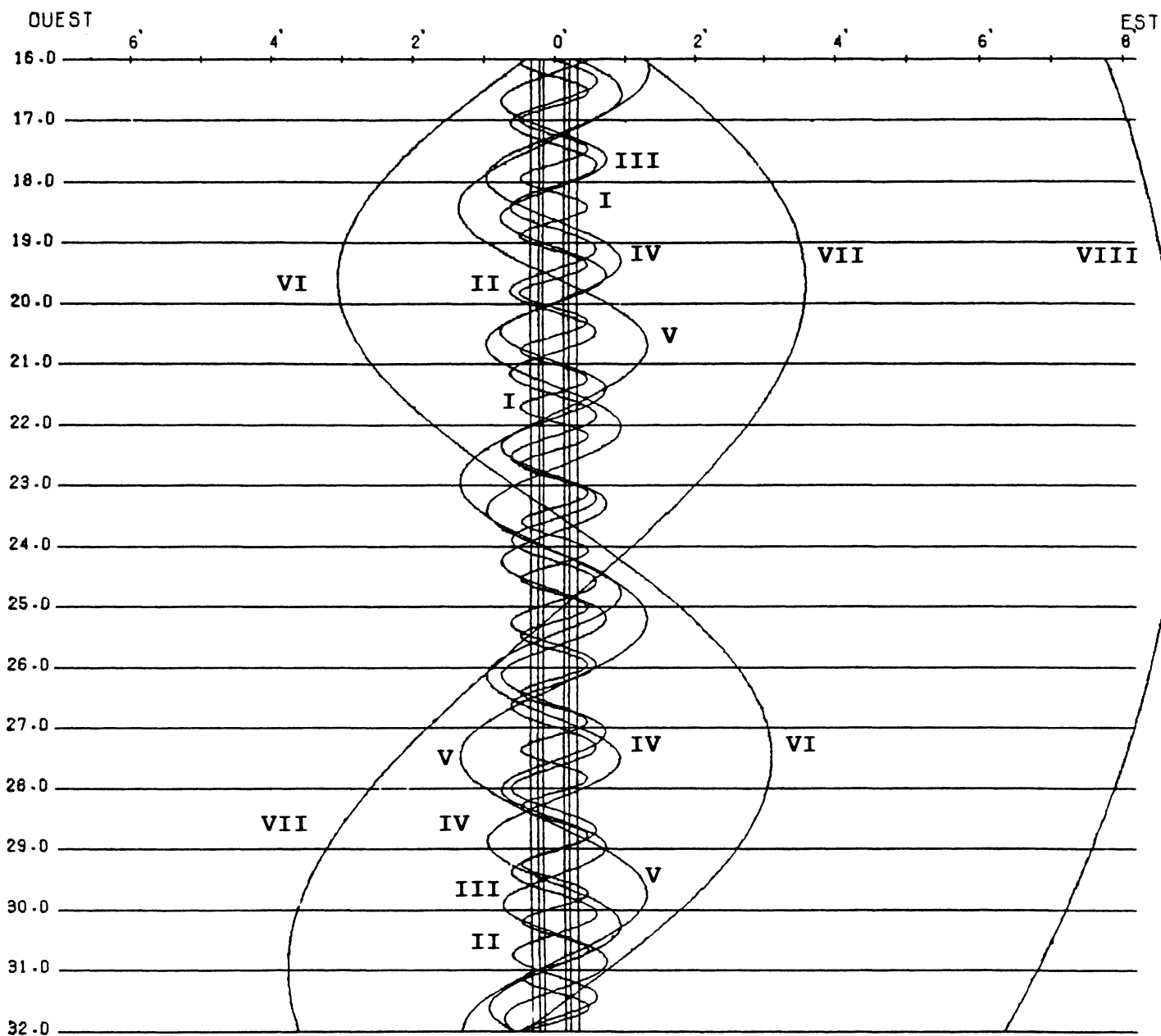

DANS LE SENS OUEST-EST, LES SATELLITES PASSENT AU-DELA DE SATURNE

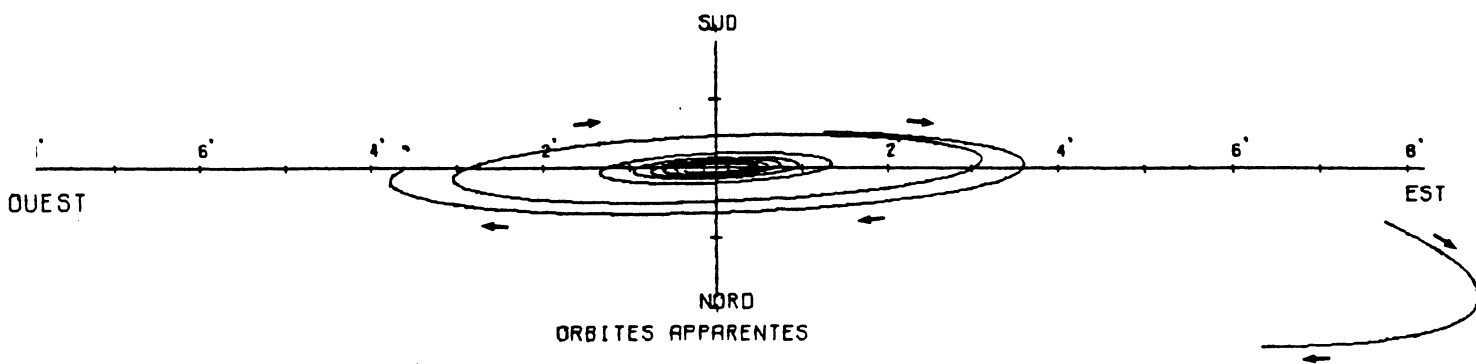

**PHÉNOMÈNES DES SATELLITES DE SATURNE POUR 1997**

**PHENOMENA OF THE SATURNIAN SATELLITES FOR 1997**

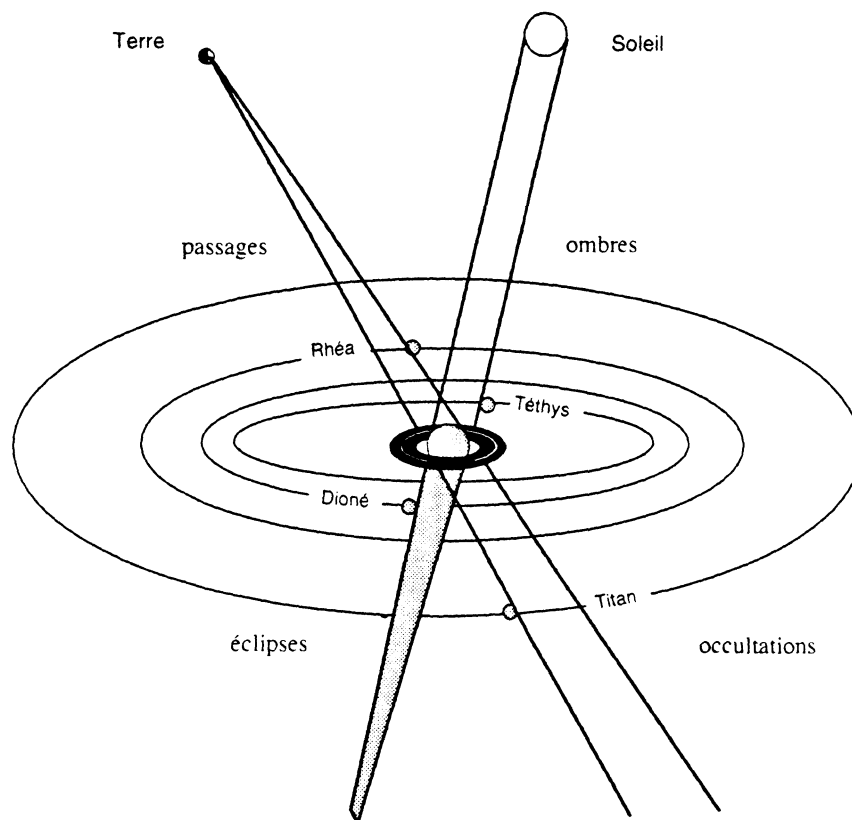

**Fig. 1.** Phénomènes des satellites de Saturne. Eclipse de Dioné, occultation de Titan, passage de Rhéa devant la planète et passage de l'ombre de Téthys sur Saturne.

## EXPLICATIONS CONCERNANT LES PREDICTIONS DES PHENOMENES DE SATURNE

Tous les quinze ans la Terre et le Soleil traversent le plan orbital des satellites de Saturne. Il est alors possible d'observer des phénomènes semblables aux phénomènes bien connus des satellites galiléens de Jupiter: éclipses et occultations des satellites par Saturne, passages de satellites devant le disque de Saturne ou passages de leur ombre projetée sur ce disque. Dans les pages suivantes on trouvera les prédictions de ces phénomènes. Pour les distances apparentes du satellite au Soleil inférieures à 30° et des distances apparentes à la Lune inférieures à 5°, le type de phénomène est marqué d'un astérisque signifiant la plus grande difficulté d'observation. C'est aussi le cas de certaines éclipses pour lesquelles le satellite se trouve à moins de 4" du bord de Saturne. Ces prédictions de phénomènes ont été réalisées à partir de la théorie des mouvements des satellites de Saturne de Dourneau (1993). On trouvera des détails sur ces prédictions dans (Arlot et Thuillot, 1993).

Nous donnons les dates des débuts et fins de passages devant Saturne (Pd et Pf), des débuts et fins de passages des ombres sur le disque de Saturne (Od et Of), des débuts et fins d'éclipses par Saturne (Ed et Ef) ainsi que celles des débuts et fins d'occultations par la planète (Im pour immersions et Em pour émergences). Ces calculs ne tiennent pas compte du diamètre des satellites et ne concernent que leur centre: ces dates correspondent donc au milieu du phénomène. Elles sont données dans l'échelle du Temps Terrestre.

Pour une trajectoire apparente équatoriale, l'intervalle de temps séparant le début et la fin des phénomènes (premiers et derniers contacts) va de 14s pour Mimas (S1) à 450s pour Titan (S6).

## REFERENCES

- Arlot, J.-E., Thuillot, W.: 1993, Eclipses and mutual events of the first eight Saturnian satellites during the 1993-1996 period, *Icarus* **105**, 427-440.
- Dourneau, G.: 1993, Observations et études du mouvement des huit premiers satellites de Saturne, *Astron. Astrophys.* **267**, 292-299.

## COMMENTS ON THE PREDICTIONS OF THE PHENOMENA BY SATURN

*Every fifteen years the Earth and the Sun pass through the orbital planes of the Saturnian satellites. It is then possible to observe phenomena similar to the well known phenomena of the Galilean satellites of Jupiter: eclipses and occultations of the satellites by Saturn, transits in front of the planetary disk, transits of the shadows of the satellites projected on the disk of the planet. In the following pages we give a list of these phenomena. Some phenomenon may be difficult to observe, they are labeled with an asterisk. This is the case for the phenomena surrounding when the sun is at less than 30°, or the moon at less than 5°. This is also the case for eclipses of satellites located at less than 4" from the edge of Saturne. The predictions have been made using Dourneau's theory of the motion of the Saturnian satellites (Dourneau, 1993). Further details on these predictions can be found in (Arlot and Thuillot, 1993).*

*We give the dates of the beginning and the end of the transits in front of Saturn (Pd and Pf), of the transits of the shadow (Od and Of), of the eclipses by Saturn (Ed and Ef), of the occultations by the planet (Im for immersions and Em for emersions). These computations are made with no consideration of the diameter of the satellites but concern their center: these dates are the dates of the mid events. They are given in the Terrestrial Time scale.*

*For an equatorial apparent orbit, the time interval between the beginning and the end of these phenomena (first and last contacts) is from 14s for Mimas (S1) up to 450s for Titan (S6).*

## 1997- PHÉNOMÈNES DES SATELLITES DE SATURNE

Jan.	h	m		18	26.7	10d	12	3.5	4Ef*	6	56.7	10f	2	5.0	40f			
1	0	3.5	30f	20	25.8	1Pf	13	33.1	1Pf	14	9.5	2Im	8	28.8	1Im			
	0	58.1	1Pd	20	42.9	10f	13	49.8	10f	15	21.3	1Im	9	23.7	2Pd			
	1	19.9	10d	23	52.9	2Im	19	6.9	2Pd	17	3.7	2Ef*	9	55.7	20d			
	2	48.6	5Em	6	2	49.5	2Ef*	19	40.7	20d	17	59.4	1Ef*	11	5.9	1Ef*		
	3	18.6	1Pf	5	6.9	1Im	21	40.9	2Pf	19	59.5	4Im	11	56.5	2Pf			
	3	35.9	10f	6	2.2	4Pd	22	2.5	20f	23	16.5	3Pd	12	16.5	20f			
	4	50.9	2Pd	7	21.9	40d	22	14.0	1Im	23	27.2	4Ef*	16	35.5	3Im			
	5	25.6	20d	7	46.5	1Ef*	11	0	53.0	1Ef*	16	0	1.8	30d	19	52.7	3Ef*	
	7	25.8	2Pf	9	2.7	4Pf	5	56.8	3Im	2	7.2	3Pf	20	4.2	1Pd			
	7	48.3	20f	9	35.7	40f	9	18.0	3Ef*	2	35.2	30f	20	24.1	10d			
	11	59.9	1Im	12	38.3	3Pd	9	49.7	1Pd	2	56.9	1Pd	22	25.2	1Pf			
	14	40.1	1Ef*	13	25.5	30d	10	10.8	10d	3	17.5	10d	22	40.8	10f			
	19	19.2	3Im	15	30.5	3Pf	11	28.0	2Im	5	17.9	1Pf	21	1	45.0	2Im		
	21	11.7	2Im	16	.4	30f	12	10.6	1Pf	5	34.1	10f	4	37.5	2Ef*			
	22	43.2	3Ef*	16	25.6	2Pd	12	27.2	10f	6	42.1	2Pd	7	6.3	1Im			
	23	35.5	1Pd	16	42.6	1Pd	14	23.4	2Ef*	7	15.0	20d	7	27.9	4Im			
	23	57.3	10d	16	60.0	20d	17	29.5	4Pd	9	15.5	2Pf	8	13.8	5Pd			
2	0	9.1	2Ef*	17	4.1	10d	18	47.9	40d	9	36.2	20f	9	43.2	1Ef*			
	1	56.1	1Pf	19	.1	2Pf	20	27.9	4Pf	13	58.8	1Im	10	50.8	4Ef*			
	2	13.3	10f	19	3.3	1Pf	20	51.5	1Im	16	36.7	1Ef*	10	55.1	5Pf			
	3	21.1	4Im	19	20.3	10f	20	59.5	40f	19	39.0	5Pd	15	15.9	3Pd			
	6	57.8	4Ef*	19	22.1	20f	23	30.2	1Ef*	21	55.9	3Im	15	59.6	30d			
	10	37.3	1Im	7	3	44.3	1Im	12	4	.7	2Pd	22	27.5	5Pf	18	5.4	3Pf	
	13	17.4	1Ef*	6	23.8	1Ef*	4	34.3	20d	4	34.3	20d	23	3.4	2Im	18	17.6	2Pd
	13	44.5	2Pd	8	46.7	2Im	4	37.1	3Pd	17	1	14.8	3Ef*	18	32.0	30f		
	14	19.2	20d	11	17.6	3Im	5	23.3	30d	1	34.4	1Pd	18	41.6	1Pd			
	16	19.3	2Pf	11	43.0	2Ef*	6	34.5	2Pf	1	54.8	10d	18	49.2	20d			
	16	41.7	20f	14	40.1	3Ef*	6	55.9	20f	1	57.2	2Ef*	19	1.4	10d			
	17	59.4	3Pd	14	48.0	4Im	7	5.1	5Pd	3	55.3	1Pf	20	50.2	2Pf			
	18	47.0	30d	15	20.0	1Pd	7	28.4	3Pf	4	11.4	10f	21	2.6	1Pf			
	20	52.0	3Pf	15	41.4	10d	7	57.3	30f	4	57.4	4Pd	21	10.0	20f			
	21	22.5	30f	17	40.7	1Pf	8	27.2	1Pd	6	13.9	40d	21	18.1	10f			
	22	12.9	1Pd	17	57.7	10f	8	48.2	10d	7	53.4	4Pf	22	5	43.8	1Im		
	22	34.7	10d	18	21.6	4Ef*	9	59.8	5Pf	8	23.2	40f	8	20.5	1Ef*			
3	0	33.5	1Pf	18	32.2	5Pd	10	48.0	1Pf	12	36.3	1Im	10	39.0	2Im			
	0	50.7	10f	21	32.1	5Pf	11	4.6	10f	15	14.0	1Ef*	13	30.9	2Ef*			
	6	.1	5Pd	8	1	19.4	2Pd	19	28.9	1Im	15	36.0	2Pd	13	55.4	3Im		
	6	5.4	2Im	1	53.5	20d	20	21.8	2Im	16	8.6	20d	16	25.9	4Pd			
	9	2.6	2Ef*	2	21.7	1Im	22	7.5	1Ef*	18	9.1	2Pf	17	11.6	3Ef*			
	9	4.5	5Pf	3	53.7	2Pf	23	16.8	2Ef*	18	29.7	20f	17	19.1	1Pd			
	9	14.6	1Im	4	15.6	20f	13	2	15.5	4Im	20	36.2	3Pd	17	38.7	10d		
	11	54.7	1Ef*	5	1.1	1Ef*	3	16.5	3Im	21	21.1	30d	17	40.0	40d			
	12	18.7	4Pd	9	57.9	3Pd	5	45.3	4Ef*	23	26.6	3Pf	19	19.1	4Pf			
	13	38.9	40d	10	44.7	30d	6	36.9	3Ef*	23	54.1	30f	19	40.1	1Pf			
	15	20.2	4Pf	12	49.8	3Pf	7	4.6	1Pd	18	0	11.8	1Pd	19	46.8	40f		
	15	53.8	40f	13	19.4	30f	7	25.5	10d	0	32.1	10d	19	55.5	10f			
	16	38.6	3Im	13	57.5	1Pd	9	25.5	1Pf	2	32.8	1Pf	23	3	11.5	2Pd		
	20	2.1	3Ef*	14	18.8	10d	9	42.0	10f	2	48.8	10f	3	42.8	20d			
	20	50.4	1Pd	16	18.2	1Pf	12	54.5	2Pd	7	57.2	2Im	4	21.3	1Im			
	21	12.0	10d	16	35.1	10f	13	27.8	20d	10	50.6	2Ef*	5	43.9	2Pf			
	22	38.2	2Pd	17	40.4	2Im	15	28.2	2Pf	11	13.8	1Im	6	3.4	20f			
	23	11.0	1Pf	20	36.4	2Ef*	15	49.3	20f	13	43.6	4Im	6	57.8	1Ef*			
	23	12.8	20d	23	45.8	4Pd	18	6.4	1Im	13	51.3	1Ef*	12	35.7	3Pd			
	23	28.1	10f	9	0	59.1	1Im	20	44.8	1Ef*	17	9.0	4Ef*	13	18.8	30d		
4	1	12.9	2Pf	1	4.9	40d	14	1	56.8	3Pd*	19	15.7	3Im	14	28.5	5Im		
	1	35.2	20f	2	45.3	4Pf	2	42.5	30d*	22	33.7	3Ef*	15	24.9	3Pf			
	7	52.0	1Im	3	17.6	40f	4	47.8	3Pf*	22	49.3	1Pd	15	50.9	30f			
	10	32.0	1Ef*	3	38.4	1Ef*	5	15.7	2Im*	23	9.4	10d	15	56.5	1Pd			
	14	59.2	2Im	8	37.2	3Im	5	16.2	30f*	19	0	29.8	2Pd	16	16.0	10d		
	15	18.8	3Pd	10	13.1	2Pd	5	42.0	1Pd*	1	2.1	20d	17	6.7	5Em			
	16	6.2	30d	10	47.1	20d	6	2.8	10d*	1	10.2	1Pf	18	17.6	1Pf			
	17	56.1	2Ef*	11	59.0	3Ef*	8	2.9	1Pf*	1	26.1	10f	18	32.8	10f			
	18	11.2	3Pf	12	34.9	1Pd	8	10.3	2Ef*	1	53.2	5Im	19	32.9	2Im			
	18	41.4	30f	12	47.3	2Pf	8	19.3	10f*	3	2.8	2Pf	22	24.4	2Ef*			
	19	27.8	1Pd	12	56.1	10d	11	13.4	4Pd	3	23.1	20f	24	1	12.3	4Im		
	19	49.4	10d	13	9.0	20f	12	30.9	40d	4	39.1	5Em	2	58.8	1Im			
	21	4.5	4Im	14	55.7	1Pf	13	18.8	5Im	9	51.3	1Im	4	32.6	4Ef*			
	21	48.4	1Pf	15	12.5	10f	14	10.6	4Pf	12	28.6	1Ef*	5	35.1	1Ef*			
	22	5.5	10f	23	36.6	1Im	14	41.3	40f	16	51.1	2Im	11	15.3	3Im			
5	0	39.7	4Ef*	10	0	45.4	5Im	16	11.4	5Em	17	56.0	3Pd	12	5.4	2Pd		
	6	29.4	1Im	2	15.7	1Ef*	16	43.8	1Im	18	40.3	30d	12	36.4	20d			
	7	31.9	2Pd	2	34.2	2Im	19	22.1	1Ef*	19	44.0	2Ef*	14	30.5	3Ef*			
	8	6.4	20d	3	43.7	5Em	21	48.3	2Pd	20	46.0	3Pf	14	34.0	1Pd			
	9	9.2	1Ef*	5	29.9	2Ef*	22	21.4	20d	21	13.0	30f	14	37.6	2Pf			
	10	6.5	2Pf	7	17.5	3Pd	15	0	21.8	2Pf	21	26.7	1Pd	14	53.3	10d		
	10	28.7	20f	8	4.0	30d	0	36.2	3Im	21	46.8	10d	14	56.8	20f			
	12	12.9	5Im	8	31.7	4Im	0	42.8	20f	22	41.6	4Pd	16	55.0	1Pf			
	13	58.1	3Im	10	9.1	3Pf	3	55.9	3Ef*	23	47.7	1Pf	17	10.1	10f			
	15	16.1	5Em	10	38.3	30f	4	19.5	1Pd	23	57.0	40d	25	1	36.4	1Im		
	17	21.1	3Ef*	11	12.3	1Pd	4	40.2	10d	20	0	3.5	10f	4	12.4	1Ef*		
	18	5.2	1Pd	11	33.5	10d	6	40.4	1Pf	1	36.2	4Pf	4	26.8	2Im			



## 1997- PHÉNOMÈNES DES SATELLITES DE SATURNE

7	17.8	2Ef*	30	0	10.6	20d	20	35.7	3Pd	12	42.0	5Pf	9	40.9	1Pd		
9	55.6	3Pd		2	12.4	2Pf	21	14.3	30d	13	55.8	3Im	9	56.1	10d		
10	10.4	4Pd		2	30.5	20f	21	31.8	2Ef*	13	59.3	2Pd	9	59.6	3Pf		
10	38.1	30d		3	15.2	3Im	22	4.9	5Pd	14	25.4	20d	10	18.7	30f		
11	23.0	40d		6	18.8	1Pd	23	21.9	3Pf	16	28.5	2Pf	11	45.6	2Ef*		
12	44.4	3Pf		6	27.2	3Ef*	23	26.1	1Pd	16	33.5	1Pd	12	1.6	1Pf		
13	1.9	4Pf		6	37.1	10d	23	43.5	10d	16	44.3	20f	12	13.2	10f		
13	9.8	30f		8	39.8	1Pf	23	44.3	30f	16	49.8	10d	14	25.6	4Pd		
13	11.4	1Pd		8	54.0	10f	4	0	11.4	4Im	17	1.6	3Ef*	15	24.2	40d	
13	28.6	40f		9	26.7	5Pd	0	16.3	5Pf	18	54.4	1Pf	17	2.3	4Pf		
13	30.6	10d		11	49.7	5Pf	1	47.1	1Pf	19	6.9	10f	17	20.6	40f		
15	32.5	1Pf		16	2.8	2Im	2	.5	10f	9	3	37.5	1Im	20	45.6	1Im	
15	47.5	10f		17	21.6	1Im	3	19.6	4Ef*	6	9.1	1Ef*	23	15.7	1Ef*		
20	49.7	5Pd		18	51.5	2Ef*	10	29.5	1Im	6	21.1	2Im	14	1	35.6	2Pd	
20	59.3	2Pd		19	56.1	1Ef*	11	17.2	2Pd	9	5.4	2Ef*	1	59.5	20d		
21	29.9	20d		21	39.7	4Pd	11	44.8	20d	11	41.8	4Im	4	3.5	2Pf		
23	22.6	5Pf		22	49.0	40d	13	2.6	1Ef*	12	36.2	3Pd	4	17.9	20f		
23	31.3	2Pf	31	0	27.7	4Pf	13	47.3	2Pf	13	11.9	30d	5	56.5	3Im		
23	50.2	20f		0	52.1	40f	14	4.1	20f	14	43.0	4Ef*	8	18.4	1Pd		
26	0	13.9	1Im	1	55.6	3Pd	19	15.5	3Im	15	11.0	1Pd	8	33.3	10d		
2	49.6	1Ef*		2	35.8	30d	22	3.6	1Pd	15	20.5	3Pf	8	58.2	3Ef*		
8	35.2	3Im		4	42.8	3Pf	22	20.8	10d	15	27.1	10d	10	39.0	1Pf		
11	48.9	1Pd		4	56.2	1Pd	22	23.9	3Ef*	15	41.0	30f	10	50.4	10f		
11	49.4	3Ef*		5	6.5	30f	5	0	24.6	1Pf	17	31.8	1Pf	17	57.5	2Im	
12	7.9	10d		5	14.4	10d	0	37.8	10f	0	37.8	10f	19	23.2	1Im		
13	20.8	2Im		7	17.3	1Pf	3	38.9	2Im	22	53.3	2Pd	20	39.0	2Ef*		
14	10.0	1Pf		7	31.4	10f	6	25.2	2Ef*	23	18.9	20d	21	53.0	1Ef*		
14	24.8	10f		8	35.2	2Pd	9	7.1	1Im	10	1	22.3	2Pf	23	12.7	4Im	
16	11.2	2Ef*		9	4.1	20d	9	9.7	4Pd	10	1	37.7	20f	15	2	6.2	4Ef*
18	56.9	4Im		11	6.1	2Pf	10	15.1	40d	2	15.1	1Im	4	36.9	3Pd		
22	14.4	4Ef*		11	23.9	20f	11	39.9	1Ef*	4	46.5	1Ef*	5	9.6	30d		
22	51.4	1Im		15	59.2	1Im	11	53.6	4Pf	11	16.0	3Im*	5	44.7	5Im		
27	1	26.9	1Ef*	18	33.4	1Ef*	12	15.6	40f	13	48.5	1Pd*	6	55.9	1Pd		
5	53.3	2Pd					17	55.8	3Pd	14	4.3	10d*	7	10.6	10d		
6	23.5	20d	Fév.	h	m		18	33.5	30d	14	20.5	3Ef*	7	16.0	5Em		
7	15.6	3Pd	1	0	35.3	3Im	20	11.2	2Pd	15	15.2	2Im*	7	19.2	3Pf		
7	57.3	30d		0	56.8	2Im	20	38.3	20d	16	9.3	1Pf*	7	37.5	30f		
8	25.0	2Pf		3	33.7	1Pd	20	41.1	1Pd	16	21.4	10f*	9	16.5	1Pf		
8	43.7	20f		3	44.9	2Ef*	20	41.4	3Pf	17	1.8	5Im*	9	27.6	10f		
10	3.8	3Pf		3	46.1	3Ef*	20	58.0	10d	17	58.8	2Ef*	10	29.7	2Pd		
10	26.4	1Pd		3	51.7	10d	21	3.2	30f	18	52.5	5Em*	10	53.0	20d		
10	28.7	30f		5	54.7	1Pf	22	41.0	2Pf	20	40.1	4Pd*	12	57.2	2Pf		
10	45.2	10d		6	8.7	10f	22	57.5	20f	21	41.1	40d*	13	11.2	20f		
12	47.4	1Pf		6	26.4	4Im	22	2.0	1Pf	23	19.4	4Pf	18	.8	1Im		
13	2.1	10f		9	37.9	4Ef*	23	15.1	10f	23	39.0	40f	20	30.3	1Ef*		
21	29.0	1Im		14	36.8	1Im	4	21.3	5Im	11	0	52.7	1Im	16	2	51.6	2Im
22	14.8	2Im		15	42.4	5Im	6	27.2	5Em	3	23.8	1Ef*	3	16.8	3Im		
28	0	4.2	1Ef*	17	10.7	1Ef*	7	44.7	1Im	7	47.4	2Pd	5	32.4	2Ef*		
1	4.7	2Ef*		17	29.2	2Pd	10	17.2	1Ef*	8	12.4	20d	5	33.4	1Pd		
3	4.8	5Im		17	57.7	20d	12	32.9	2Im	9	56.4	3Pd	5	47.8	10d		
3	55.0	4Pd		18	1.0	5Em	15	18.6	2Ef*	10	16.0	2Pf	6	17.0	3Ef*		
5	6.0	40d		19	59.8	2Pf	16	35.6	3Im	10	31.1	20f	7	53.9	1Pf		
5	34.1	5Em		20	17.3	20f	17	56.5	4Im	10	31.2	30d	8	4.9	10f		
5	55.2	3Im		23	15.6	3Pd	19	18.5	1Pd	12	25.9	1Pd	8	11.2	4Pd		
6	44.8	4Pf		23	55.0	30d	19	35.3	10d	12	40.1	3Pf	9	7.2	40d		
7	10.4	40f		2	2.4	3Pf	19	42.8	3Ef*	12	41.6	10d	10	45.2	4Pf		
9	3.8	1Pd	2	2	11.2	1Pd	21	1.3	4Ef*	12	59.8	30f	11	2.2	40f		
9	8.3	3Ef*		2	25.4	30f	21	39.5	1Pf	14	46.7	1Pf	16	38.5	1Im		
9	22.5	10d		2	28.9	10d	21	52.4	10f	14	58.7	10f	19	7.6	1Ef*		
11	24.9	1Pf		4	32.2	1Pf	7	5.2	2Pd	14	58.7	10f	19	23.8	2Pd		
11	39.4	10f		4	45.9	10f	5	31.8	20d	12	0	9.3	2Im	19	46.5	20d	
14	47.2	2Pd		9	50.8	2Im	6	22.3	1Im	2	1.1	1Ef*	21	51.0	2Pf		
15	17.0	20d		12	38.4	2Ef*	7	34.8	2Pf	2	52.2	2Ef*	22	4.6	20f		
17	18.7	2Pf		13	14.4	1Im	7	50.9	20f	5	27.2	4Im	17	1	57.2	3Pd	
17	37.1	20f		15	24.6	4Pd	8	54.5	1Ef*	8	24.6	4Ef*	2	28.8	30d		
20	6.5	1Im		15	48.0	1Ef*	15	16.0	3Pd	8	36.3	3Im	4	10.8	1Pd		
22	41.5	1Ef*		16	32.1	40d	15	52.7	30d	11	3.4	1Pd	4	25.0	10d		
29	4	35.6	3Pd	18	10.7	4Pf	17	56.0	1Pd	11	18.8	10d	4	38.7	3Pf		
5	16.6	30d		18	33.9	40f	18	1.0	3Pf	11	39.4	3Ef*	4	56.4	30f		
7	8.8	2Im		21	55.3	3Im	18	12.6	10d	13	24.1	1Pf	6	31.3	1Pf		
7	23.3	3Pf	3	0	48.6	1Pd	18	22.1	30f	13	35.9	10f	6	42.1	10f		
7	41.3	1Pd		1	5.0	3Ef*	20	16.9	1Pf	16	41.5	2Pd	11	45.8	2Im		
7	47.6	30f		1	6.2	10d	20	29.6	10f	17	6.0	20d	12	11.2	5Pd		
7	59.8	10d		2	23.2	2Pd	21	27.0	2Im	19	9.8	2Pf	13	28.2	5Pf		
9	58.1	2Ef*		2	51.2	20d	8	0	12.0	2Ef*	19	24.5	20f	14	25.8	2Ef*	
10	2.3	1Pf		3	9.6	1Pf	2	54.8	4Pd	22	8.0	1Im	15	16.1	1Im		
10	16.7	10f		3	23.2	10f	3	58.1	40d	23	26.4	5Pd	16	58.4	4Im		
12	41.6	4Im		4	53.6	2Pf	4	59.9	1Im	13	0	38.4	1Ef*	17	44.9	1Ef*	
15	56.1	4Ef*		5	10.7	20f	5	36.5	4Pf	1	6.4	5Pf	19	47.8	4Ef*		
18	44.1	1Im		11	51.9	1Im	5	57.3	40f	7	16.6	3Pd	18	0	37.2	3Im	
21	18.8	1Ef*		14	25.3	1Ef*	7	31.8	1Ef*	7	50.4	30d	2	48.3	1Pd		
23	41.2	2Pd		18	44.8	2Im	10	44.6	5Pd	9	3.4	2Im	3	2.3	10d		

1997- PHÉNOMÈNES DES SATELLITES DE SATURNE

3	35.9	3Ef*	22	15.9	1Pf	12	49.2	30f*	14	34.1	1Im*	17	55.1	10d*				
4	17.9	2Pd	22	25.4	10f	14	.3	1Pf*	15	7.9	2Pd*	19	7.3	2Im*				
4	40.0	20d	23	22.4	2Im	14	8.5	10f*	15	21.9	20d*	20	6.1	1Pf*				
5	8.8	1Pf	23	59.3	2Ef*	16	2.5	4Im*	17	29.6	2Pf*	20	11.3	10f*				
5	19.3	10f	4	30.2	4Im*	22	48.0	1Im*	17	38.1	20f*	13	0	7.8	4Pd*			
6	44.7	2Pf	7	2.0	1Im				7	0	41.5	3Im*	0	34.5	40d*			
6	58.0	20f	9	28.7	1Ef*	Mars	h	m	2	3.2	1Pd*	2	8.2	4Pf*				
13	53.7	1Im	15	54.4	2Pd	1	3	31.1	2Pd*	2	12.0	10d*	2	15.5	40f*			
16	22.2	1Ef*	16	14.1	20d	3	3	48.0	20d*	4	22.0	1Pf*	4	58.0	1Im*			
20	39.9	2Im	16	38.4	3Im	5	5	54.7	2Pf*	4	28.6	10f*	11	39.0	2Pd*			
23	17.6	3Pd	18	19.7	2Pf	6	4	8	20f*	7	30.3	2Im*	11	49.3	20d*			
23	19.2	2Ef*	18	31.4	20f	8	39.8	3Im*	12	34.2	4Pd*	13	58.2	2Pf*				
23	48.0	30d	18	33.3	1Pd	10	18.2	1Pd*	13	8.4	40d*	14	4.6	20f*				
19	1	25.8	1Pd	18	45.6	10d	10	28.9	10d*	13	11.8	1Im*	15	23.7	3Pd*			
1	39.5	10d	19	32.3	3Ef*	11	28.7	3Ef*	14	43.7	4Pf*	15	38.1	30d*				
1	56.9	4Pd	20	53.3	1Pf	12	37.7	1Pf*	14	52.8	40f*	16	25.7	1Pd*				
1	58.3	3Pf	21	2.6	10f	12	45.6	10f*	23	21.9	3Pd*	16	32.3	10d*				
2	15.2	30f	24	5	39.7	1Im	19	53.4	2Im*	23	40.6	30d*	17	52.3	3Pf*			
2	50.2	40d	8	16.6	2Im	21	25.7	1Im*	8	0	2.1	2Pd*	18	.5	30f*			
3	46.2	1Pf	10	52.7	2Ef*	2	1	1.1	4Pd*	0	15.4	20d*	18	43.4	1Pf*			
3	56.5	10f	13	28.7	4Pd	1	42.3	40d*	0	40.7	1Pd*	18	48.4	10f*				
4	28.0	4Pf	14	16.3	40d	3	18.8	4Pf*	0	49.2	10d*	14	3	35.7	1Im*			
4	43.8	40f	15	18.8	3Pd	3	29.9	40f*	1	53.9	3Pf*	4	1.5	21m*				
12	31.4	1Im	15	45.6	30d	7	20.2	3Pd*	2	4.3	30f*	8	56.0	4Im*				
13	12.0	2Pd	15	53.6	4Pf	7	43.1	30d*	2	23.3	2Pf*	14	4.0	3Im*				
13	33.5	20d	16	6.9	40f	8	55.7	1Pd*	2	31.4	20f*	15	3.2	1Pd*				
14	59.5	1Ef*	17	10.8	1Pd	9	6.1	10d*	2	59.3	1Pf*	15	9.5	10d*				
15	38.5	2Pf	17	22.8	10d	9	55.4	3Pf*	3	5.7	10f*	17	20.8	1Pf*				
15	51.3	20f	17	56.9	3Pf	10	8.0	30f*	11	49.5	1Im*	17	25.5	10f*				
18	31.7	5Im	18	11.6	30f	11	15.1	1Pf*	16	24.5	2Im*	20	33.2	2Pd*				
19	35.9	5Em	19	30.7	1Pf	11	22.8	10f*	21	22.1	4Im*	20	42.7	20d*				
21	57.6	3Im	19	39.8	10f	12	25.3	2Pd*	22	2.1	3Im*	22	51.9	2Pf*				
20	0	3.3	1Pd	25	0	48.6	2Pd	12	41.5	20d*	23	18.2	1Pd*	22	57.9	20f*		
0	16.7	10d	1	7.6	20d	14	48.4	2Pf*	14	58.1	20f*	23	26.4	10d*	15	2	13.4	1Im*
0	54.7	3Ef*	3	13.5	2Pf	14	58.1	20f*	9	1	36.7	1Pf*	1	36.7	1Pf*	12	44.4	3Pd*
2	23.6	1Pf	3	24.8	20f	20	3.4	1Im*	1	42.8	10f*	1	42.8	10f*	12	55.8	2Im*	
2	33.8	10f	4	17.3	1Im	3	4	47.6	2Im*	8	56.3	2Pd*	8	56.3	2Pd*	12	57.2	30d*
5	34.1	2Im	13	58.8	3Im*	6	.3	3Im*	6	.3	3Im*	9	8.9	20d*	13	40.7	1Pd*	
8	12.6	2Ef*	15	48.3	1Pd*	7	33.2	1Pd*	10	27.2	1Im*	10	27.2	1Im*	13	46.6	10d*	
10	44.2	4Im	16	.0	10d*	7	43.3	10d*	11	17.0	2Pf*	11	17.0	2Pf*	15	11.7	3Pf*	
11	9.0	1Im	16	51.1	3Ef*	9	48.9	4Im*	11	24.7	20f*	11	24.7	20f*	15	19.2	30f*	
13	36.8	1Ef*	17	10.8	2Im*	9	52.5	1Pf*	20	42.5	3Pd*	20	42.5	3Pd*	15	58.1	1Pf*	
20	37.9	3Pd	18	8.1	1Pf*	9	60.0	10f*	20	59.8	30d*	20	59.8	30d*	16	2.6	10f*	
21	7.2	30d	18	16.9	10f*	18	41.0	1Im*	21	55.7	1Pd*	21	55.7	1Pd*	17	54.9	4Pd*	
22	6.1	2Pd	19	46.1	2Ef*	21	19.5	2Pd*	22	3.6	10d*	22	3.6	10d*	18	17.5	40d*	
22	27.0	20d	22	16.3	4Im*	21	35.0	20d*	23	13.4	3Pf*	23	13.4	3Pf*	19	50.1	4Pf*	
22	40.8	1Pd	2	55.0	1Im*	23	42.2	2Pf*	23	23.0	30f*	23	23.0	30f*	19	56.9	40f*	
22	54.0	10d	9	42.8	2Pd*	23	51.4	20f*	10	0	14.1	1Pf*	16	0	51.1	1Im*		
23	17.8	3Pf	10	1.0	20d*	4	4	40.7	3Pd*	10	0	20.0	10f*	5	27.5	2Pd*		
23	34.0	30f	12	7.2	2Pf*	5	2.3	30d*	5	2.3	30d*	1	18.8	2Im*	5	36.2	20d*	
21	0	32.2	2Pf	12	18.1	20f*	6	10.7	1Pd*	6	10.7	1Pd*	6	20.9	4Pd*	7	45.6	2Pf*
0	44.7	20f	12	39.2	3Pd*	6	20.5	10d*	6	20.5	10d*	6	51.4	40d*	7	51.2	20f*	
1	1.0	1Pf	13	4.8	30d*	7	14.9	3Pf*	7	14.9	3Pf*	8	26.0	4Pf*	11	24.7	3Im*	
1	11.0	10f	14	25.8	1Pd*	7	26.8	30f*	8	34.2	40f*	8	34.2	40f*	12	18.2	1Pd*	
9	46.7	1Im	14	37.3	10d*	8	29.8	1Pf*	9	4.9	1Im*	9	4.9	1Im*	12	23.8	10d*	
12	14.1	1Ef*	15	16.4	3Pf*	8	37.1	10f*	17	50.5	2Pd*	17	50.5	2Pd*	14	35.5	1Pf*	
14	28.2	2Im	15	30.4	30f*	13	41.8	2Im*	18	2.3	20d*	18	2.3	20d*	14	39.7	10f*	
17	5.9	2Ef*	16	45.5	1Pf*	17	18.7	1Im*	19	22.7	3Im*	19	22.7	3Im*	21	50.0	2Im*	
19	18.0	3Im	16	54.1	10f*	18	47.6	4Pd*	20	10.8	2Pf*	20	10.8	2Pf*	23	28.8	1Im*	
19	42.7	4Pd	1	32.7	1Im*	19	25.4	40d*	20	18.0	20f*	20	18.0	20f*	2	43.3	4Im*	
20	33.3	40d	2	5.0	2Im*	21	1.3	4Pf*	20	33.2	1Pd*	20	33.2	1Pd*	10	5.1	3Pd*	
21	18.3	1Pd	7	14.9	4Pd*	21	11.4	40f*	20	40.8	10d*	20	40.8	10d*	10	16.3	30d*	
21	31.2	10d	7	59.3	40d*	3	20.9	3Im*	22	51.4	1Pf*	22	51.4	1Pf*	10	55.7	1Pd*	
22	10.8	4Pf	9	36.2	4Pf*	4	48.2	1Pd*	22	57.1	10f*	22	57.1	10f*	11	.9	10d*	
22	13.5	3Ef*	9	48.4	40f*	4	57.7	10d*	11	7	42.6	1Im*	7	42.6	1Im*	12	31.1	3Pf*
22	25.4	40f	11	19.3	3Im*	6	13.7	2Pd*	10	13.0	2Im*	10	13.0	2Im*	12	37.9	30f*	
23	38.4	1Pf	13	3.2	1Pd*	6	28.5	20d*	15	9.0	4Im*	15	9.0	4Im*	13	12.8	1Pf*	
23	48.2	10f	13	14.5	10d*	7	7.2	1Pf*	18	3.1	3Pd*	18	3.1	3Pd*	13	16.8	10f*	
22	1	3.5	5Pd	14	9.9	3Ef*	7	14.3	10f*	18	18.9	30d*	18	18.9	30d*	14	21.7	2Pd*
1	43.0	5Pf	15	22.9	1Pf*	8	35.9	2Pf*	19	10.7	1Pd*	19	10.7	1Pd*	14	29.6	20d*	
7	.3	2Pd	15	31.3	10f*	8	44.8	20f*	19	17.9	10d*	19	17.9	10d*	16	39.3	2Pf*	
7	20.6	20d	18	36.9	2Pd*	15	56.4	1Im*	20	32.8	3Pf*	20	32.8	3Pf*	16	44.5	20f*	
8	24.3	1Im	18	54.5	20d*	22	36.0	2Im*	20	41.7	30f*	20	41.7	30f*	22	6.5	1Im*	
9	26.0	2Pf	21	1.0	2Pf*	2	1.3	3Pd*	21	28.8	1Pf*	21	28.8	1Pf*	6	44.3	2Im*	
9	38.1	20f	21	11.4	20f*	2	21.5	30d*	21	34.2	10f*	21	34.2	10f*	8	45.4	3Im*	
10	51.4	1Ef*	28	0	10.3	1Im*	3	25.7	1Pd*	12	2	44.8	2Pd*	9	33.2	1Pd*		
17	58.3	3Pd	9	59.7	3Pd*	3	34.8	10d*	3	34.8	10d*	2	55.8	20d*	9	38.1	10d*	
18	26.4	30d	10	24.0	30d*	3	35.4	4Im*	5	4.5	2Pf*	5	4.5	2Pf*	11	42.2	4Pd*	
19	55.8	1Pd	10	59.2	2Im*	4	34.4	3Pf*	5	11.3	20f*	5	11.3	20f*	11	50.1	1Pf*	
20	8.4	10d	11	40.7	1Pd*	4	45.5	30f*	6	20.3	1Im*	6	20.3	1Im*	11	53.9	10f*	
20	37.3	3Pf	11	51.7	10d*	5	44.6	1Pf*	16	43.3	3Im*	16	43.3	3Im*	12	.6	40d*	
20	52.8	30f	12	35.9	3Pf*	5	51.4	10f*	17	48.2	1Pd*	17	48.2	1Pd*	13	32.0	4Pf*	

1997- PHÉNOMÈNES DES SATELLITES DE SATURNE

19	13	38.2	40f*	19	47.7	10f*	22	55.3	20f*	27	0	36.5	3Ed*	12	14.4	2Ed*	
	20	44.2	1Im*	19	50.3	1Pf*	22	59.1	2Pf*		0	40.9	2Ed*	14	29.4	2Em*	
	23	16.0	2Pd*	20	17.3	30f*	21	7	54.9	10d*	1	48.2	10f*	15	20.3	10d*	
	23	23.1	20d*	20	19.0	3Pf*		8	3.6	1Pd*	1	53.1	1Pf*	15	33.6	1Pd*	
	1	32.9	2Pf*	21	11.7	40d*		8	39.4	3Ed*	2	51.6	3Em*	16	18.1	4Ed*	
	1	37.8	20f*	22	28.8	40f*		10	6.5	10f*	2	55.6	2Em*	16	33.5	3Ed*	
	7	25.8	3Pd*	15	7	4.1	1Em*	10	10.4	1Pf*	4	51.2	4Ed*	17	29.8	10f*	
	7	35.5	30d*	9	11.2	20d*		10	55.3	3Em*	13	10.4	1Em*	17	35.7	1Pf*	
	8	10.8	1Pd*	9	21.4	2Pd*		13	7.4	2Ed*	17	11.5	20d*	18	47.5	3Em*	
	8	15.3	10d*	11	22.5	20f*		15	21.6	2Em*	17	29.7	2Pd*	3	2	42.7	1Ed*
	9	50.4	3Pf*	11	25.1	2Pf*		17	24.5	4Ed*	19	21.1	20f*	4	44.8	20d*	
	9	56.6	30f*	16	12.2	10d*		21	26.0	1Em*	19	26.4	2Pf*	4	54.6	1Em*	
	10	27.4	1Pf*	16	18.5	1Pd*	22	5	38.0	20d*	22	14.8	10d*	5	6.6	2Pd*	
	10	31.0	10f*	18	24.7	10f*		5	52.8	2Pd*	22	26.1	1Pd*	6	53.7	20f*	
	15	38.6	2Im*	18	27.5	1Pf*		6	32.1	10d*	23	16.2	30d*	7	.1	2Pf*	
	19	21.9	1Im*	18	58.6	3Em*		6	41.1	1Pd*	23	44.4	3Pd*	13	57.4	10d*	
	20	30.7	4Im*	16	3	47.5	2Em*	7	19.0	30d*	28	0	25.1	10f*	14	11.1	1Pd*
	6	6.1	3Im*	5	41.6	1Em*		7	41.4	3Pd*		0	30.2	1Pf*	15	13.3	30d*
	6	48.3	1Pd*	5	58.0	4Ed*		7	48.4	20f*		1	27.0	30f*	15	47.5	3Pd*
	6	52.4	10d*	14	49.3	10d*		7	52.6	2Pf*		1	30.9	3Pf*	16	6.7	10f*
	8	10.2	2Pd*	14	56.0	1Pd*		8	43.5	10f*	9	34.3	2Ed*	16	12.8	1Pf*	
	8	16.5	20d*	15	21.9	30d*		8	47.5	1Pf*	11	47.8	1Em*	17	22.4	30f*	
	9	4.7	1Pf*	15	38.5	3Pd*		9	31.5	30f*	11	49.1	2Em*	17	26.7	3Pf*	
	9	8.1	10f*	17	1.7	10f*		9	34.6	3Pf*	13	48.3	40d*	21	7.7	2Ed*	
	10	26.6	2Pf*	17	4.6	1Pf*		20	3.4	1Em*	14	52.0	40f*	23	22.9	2Em*	
	10	31.1	20f*	17	35.9	30f*	23	22	.8	2Ed*	20	51.9	10d*	4	1	15.4	40d*
	17	59.7	1Im*	17	38.0	3Pf*		0	15.1	2Em*	21	3.6	1Pd*	1	20.1	1Ed*	
				18	4.6	20d*		2	21.5	40d*	21	55.5	3Ed*	2	12.8	40f*	
				18	15.7	2Pd*		3	30.9	40f*	23	2.1	10f*	3	31.9	1Em*	
				20	15.7	20f*		5	9.2	10d*	23	7.3	1Pf*	12	34.6	10d*	
				20	18.6	2Pf*		5	18.6	1Pd*	29	0	10.3	3Em*	12	48.6	1Pd*
				4	19.0	1Em*		5	58.4	3Ed*	2	4.8	20d*	13	38.2	20d*	
				12	41.0	2Em*		7	20.4	10f*	2	24.0	2Pd*	13	52.6	3Ed*	
				13	26.5	10d*		7	24.7	1Pf*	4	14.3	20f*	14	.9	2Pd*	
				13	33.5	1Pd*		8	14.1	3Em*	4	19.9	2Pf*	14	43.7	10f*	
				14	1.3	3Ed*		14	31.4	20d*	8	13.3	1Ed*	14	49.9	1Pf*	
				14	55.0	40d*		14	47.0	2Pd*	10	25.1	1Em*	15	46.8	20f*	
				15	38.7	10f*		16	41.6	20f*	18	27.6	2Ed*	15	53.5	2Pf*	
				15	41.8	1Pf*		16	46.1	2Pf*	19	29.0	10d*	16	6.1	3Em*	
				16	9.6	40f*		18	40.8	1Em*	19	41.1	1Pd*	23	57.5	1Ed*	
				16	17.5	3Em*	24	3	46.3	10d*	20	35.2	30d*	5	2	9.3	1Em*
				2	56.4	1Em*		3	56.1	1Pd*	20	42.5	2Em*	6	1.1	2Ed*	
				2	57.9	20d*		4	38.1	30d*	21	5.4	3Pd*	8	16.3	2Em*	
				3	10.0	2Pd*		5	2.4	3Pd*	21	39.0	10f*	10	1.6	4Ed*	
				5	8.9	20f*		5	57.4	10f*	21	44.4	1Pf*	10	57.5	4Ef*	
				5	12.1	2Pf*		6	1.8	1Pf*	22	34.6	4Ed*	11	11.7	10d	
				12	3.6	10d*		6	50.0	30f*	22	45.5	30f*	11	26.1	1Pd*	
				12	11.1	1Pd*		6	53.4	3Pf*	22	49.5	3Pf*	12	32.3	30d	
				12	40.9	30d*		6	54.2	2Ed*	30	6	50.7	1Ed*	13	8.5	3Pd
				12	59.5	3Pd*		9	8.6	2Em*	9	2.5	1Em*	13	20.6	10f	
				14	15.6	10f*		11	7.8	4Ed*	10	58.2	20d*	13	26.9	1Pf	
				14	18.9	1Pf*		17	18.2	1Em*	11	18.2	2Pd*	14	40.9	30f	
				14	54.4	30f*		23	24.8	20d*	13	7.4	20f*	14	45.2	3Pf	
				14	56.9	3Pf*		23	41.3	2Pd*	13	13.3	2Pf*	22	31.5	20d	
				21	34.6	2Em*	25	1	34.8	20f*	18	6.1	10d*	22	34.8	1Ed*	
				23	41.2	4Ed*		1	39.5	2Pf*	18	18.6	1Pd*	22	55.1	2Pd	
				1	33.8	1Em*		2	23.4	10d*	19	14.5	3Ed*	6	0	40.0	20f
				10	40.7	10d*		2	33.6	1Pd*	20	15.9	10f*	0	46.6	1Em	
				10	48.6	1Pd*		3	17.4	3Ed*	20	21.5	1Pf*	0	46.8	2Pf	
				11	20.3	3Ed*		4	34.3	10f*	21	28.9	3Em*	9	48.8	10d	
				11	51.3	20d*		4	38.9	1Pf*				10	3.6	1Pd	
				12	4.2	2Pd*		5	32.9	3Em*				11	11.6	3Ed*	
				12	52.6	10f*		15	47.5	2Ed*				11	57.5	10f	
				12	56.1	1Pf*		15	55.6	1Em*				12	4.0	1Pf	
				13	36.4	3Em*		18	2.1	2Em*				13	24.6	3Em*	
				14	2.1	20f*		20	4.9	40d*				14	54.5	2Ed*	
				14	5.6	2Pf*		21	11.5	40f*				17	9.7	2Em	
				0	11.2	1Em*	26	1	.5	10d*				8	32.4	40f*	
				6	28.1	2Em*		1	11.1	1Pd*				16	43.2	10d*	
				8	38.2	40d*		1	57.1	30d*				16	56.1	1Pd*	
				9	17.8	10d*		2	23.4	3Pd*				17	54.2	30d*	
				9	26.1	1Pd*		3	11.3	10f*				18	26.4	3Pd*	
				9	50.3	40f*		3	16.0	1Pf*				18	52.9	10f*	
				9	60.0	30d*		4	8.5	30f*				18	58.6	1Pf*	
				10	20.4	3Pd*		4	12.2	3Pf*				19	51.5	20d*	
				11	29.6	10f*		8	18.1	20d*				20	3.9	30f*	
				11	33.2	1Pf*		8	35.5	2Pd*				20	8.1	3Pf*	
				12	12.9	30f*		10	27.9	20f*				20	12.4	2Pd*	
				12	15.8	3Pf*		10	33.0	2Pf*				22	.6	20f*	
				20	44.7	20d*		14	33.0	1Em*				22	6.7	2Pf*	
				20	58.5	2Pd*		23	37.6	10d*	2	4	5.4	1Ed*	10	41.1	1Pf
				22	48.6	1Em*		23	48.6	1Pd*		6	17.2	1Em*	11	59.3	30f

1997- PHÉNOMÈNES DES SATELLITES DE SATURNE

12	3.7	3Pf	2	15.9	10f	8	46.8	2Pf	18	38.9	2Pd	6	15.1	2Pd	
19	49.5	1Ed*	2	23.3	1Pf	15	51.3	10d	20	10.4	20f	7	42.8	20f	
22	1.3	1Em	2	32.9	3Pd	16	10.9	1Pd	20	19.8	2Pf	7	52.7	2Pf	
23	47.8	2Ed*	3	54.6	30f	17	45.5	30d	20	24.3	1Ed*	12	8.2	1Ed*	
8	2	3.1	2Em	3	58.7	3Pf	17	57.4	10f	22	35.4	1Em	14	18.9	1Em
3	45.3	4Ed*	11	21.2	2Ed*	18	5.5	1Pf	24	7	34.0	10d	22	1.1	2Ed*
4	37.6	4Ef*	11	33.6	1Ed*	18	36.3	3Pd	7	55.7	1Pd	23	16.8	10d	
7	3.0	10d	13	36.6	2Em	19	49.8	30f	9	38.8	10f	23	40.4	1Pd	
7	18.6	1Pd	13	45.2	1Em	19	53.2	3Pf	9	42.5	30d	30	0	16.2	2Em
8	30.6	3Ed*	15	13.1	4Ed*	22	54.5	2Ed*	9	47.5	1Pf	1	20.2	10f	
9	11.3	10f	15	57.3	4Ef*	19	9.9	2Em	10	27.8	2Ed*	1	29.5	1Pf	
9	18.1	1Pf	22	45.7	10d	2	41.7	4Ed*	10	40.0	3Pd	1	39.5	30d	
10	43.0	3Em	23	3.5	1Pd	3	16.1	4Ef*	11	45.0	30f	2	44.1	3Pd	
16	18.2	20d	14	0	27.6	3Ed*	3	17.6	1Ed*	11	47.0	3Pf	3	39.9	3Pf
16	43.4	2Pd	0	52.8	10f	5	29.0	1Em	12	43.1	2Em	3	40.0	30f	
18	26.2	20f	1	.4	1Pf	14	28.4	10d	14	12.6	4Ed*	10	45.6	1Ed*	
18	26.9	1Ed*	2	38.0	3Em	14	48.4	1Pd	14	32.5	4Ef*	12	56.1	1Em	
18	33.6	2Pf	3	51.5	20d	15	24.7	20d	19	1.6	1Ed*	14	31.1	20d	
20	38.6	1Em	4	20.1	2Pd	15	56.6	2Pd	21	12.6	1Em	15	9.1	2Pd	
9	5	40.1	10d	5	58.7	20f	16	24.6	3Ed*	25	2	57.9	20d		
5	56.1	1Pd	6	6.9	2Pf	16	34.3	10f	3	33.0	2Pd	16	45.9	2Pf	
7	10.4	30d	10	10.9	1Ed*	16	42.5	1Pf	5	3.5	20f	21	53.9	10d	
7	48.3	10f	12	22.5	1Em	17	31.1	20f	5	13.0	2Pf	22	17.8	1Pd	
7	50.7	3Pd	20	14.5	2Ed*	17	40.0	2Pf	6	11.1	10d	23	57.1	10f	
7	55.2	1Pf	21	22.8	10d	18	32.3	3Em	6	33.2	1Pd	31	0	6.4	1Pf
8	41.2	2Ed*	21	41.0	1Pd	1	55.0	1Ed*	8	15.7	10f	8	15.7	10f	
9	17.7	30f	22	29.9	2Em	4	6.3	1Em	8	21.5	3Ed*	6	54.4	2Ed*	
9	22.1	3Pf	23	7.4	30d	7	47.9	2Ed*	8	24.5	1Pf	9	9.4	2Em	
10	56.5	2Em	23	29.7	10f	10	3.3	2Em	10	26.0	3Em	9	22.9	1Ed*	
12	42.8	40d	23	37.4	1Pf	11	40.0	40d	17	39.0	1Ed*	11	33.3	1Em	
13	33.0	40f	23	54.0	3Pd	12	10.9	40f	19	21.2	2Ed*	20	31.0	10d*	
17	4.2	1Ed*	15	0	10.8	40d	13	5.5	10d	19	49.9	1Em	20	55.3	1Pd*
19	16.0	1Em	0	52.5	40f	13	25.9	1Pd	21	36.4	2Em	22	34.0	10f*	
10	1	11.5	20d	1	13.0	30f	15	4.5	30d	23	12.8	40d	22	43.4	1Pf*
1	37.6	2Pd	1	17.0	3Pf	15	11.2	10f	23	25.4	40f	22	58.5	30d*	
3	19.4	20f	8	48.3	1Ed*	15	19.5	1Pf	26	4	48.3	10d	23	24.4	20d*
3	26.9	2Pf	10	59.8	1Em	15	57.5	3Pd	5	10.6	1Pd				
4	17.2	10d	12	44.8	20d	17	8.2	30f	6	52.6	10f	Juin	h	m	
4	33.6	1Pd	13	14.3	2Pd	17	11.2	3Pf	7	1.5	30d	1	0	3.1	2Pd*
5	49.6	3Ed*	14	51.8	20f	0	18.0	20d	7	1.5	1Pf	0	0	5.6	3Pd*
6	25.2	10f	15	.2	2Pf	0	32.3	1Ed*	8	1.3	3Pd	0	0	57.3	3Pf*
6	32.2	1Pf	19	59.9	10d	0	50.7	2Pd	9	3.3	30f	0	0	58.4	30f*
8	1.4	3Em	20	18.5	1Pd	2	24.2	20f	9	4.7	3Pf	1	1	28.9	20f*
15	41.6	1Ed*	21	46.6	3Ed*	2	33.3	2Pf	11	51.2	20d	1	1	39.1	2Pf*
17	34.5	2Ed*	22	6.6	10f	2	43.6	1Em	12	27.0	2Pd	8	.2	1Ed*	
17	53.3	1Em	22	14.4	1Pf	11	42.7	10d	13	56.6	20f	10	10.6	1Em*	
19	49.9	2Em	23	56.2	3Em	12	3.3	1Pd	14	6.3	2Pf	15	47.7	2Ed*	
21	29.1	4Ed*	5	7.9	2Ed*	13	43.6	3Ed*	16	16.3	1Ed*	18	2.6	2Em	
22	17.5	4Ef*	7	23.3	2Em	13	48.1	10f	18	27.1	1Em	19	8.1	10d	
11	2	54.4	10d	7	25.6	1Ed*	13	56.5	1Pf	27	3	25.4	10d		
3	11.1	1Pd	8	57.2	4Ed*	15	50.3	3Em	3	48.1	1Pd	19	32.7	1Pd	
4	29.4	30d	9	36.9	4Ef*	16	41.2	2Ed*	4	14.5	2Ed*	21	10.9	10f	
5	2.1	10f	9	37.1	1Em	18	56.6	2Em	5	29.5	10f	21	20.4	1Pf	
5	9.3	1Pf	18	37.1	10d	20	26.7	4Ed*	5	38.5	1Pf	21	37.5	3Ed*	
5	11.8	3Pd	18	56.0	1Pd	20	54.8	4Ef*	5	40.5	3Ed*	2	6	37.5	1Ed*
6	36.2	30f	20	26.4	30d	23	9.6	1Ed*	6	29.7	2Em	8	47.8	1Em	
6	40.4	3Pf	20	43.5	10f	1	20.8	1Em	7	43.7	3Em	8	57.1	2Pd	
10	4.8	20d	20	51.5	1Pf	9	11.3	20d	14	53.6	1Ed*	10	22.0	20f	
10	31.8	2Pd	21	15.1	3Pd	9	44.8	2Pd	17	4.4	1Em	10	32.2	2Pf	
12	12.5	20f	21	38.1	20d	10	19.8	10d	20	44.5	20d	17	45.3	10d	
12	20.3	2Pf	22	8.4	2Pd	10	40.8	1Pd	21	21.1	2Pd	18	10.1	1Pd	
14	18.9	1Ed*	22	31.4	30f	11	17.3	20f	22	49.7	20f	19	47.8	10f	
16	30.6	1Em	22	35.2	3Pf	11	26.6	2Pf	22	59.5	2Pf	19	57.4	1Pf	
12	1	31.5	10d	23	44.9	20f	12	23.5	30d	28	2	2.5	10d		
1	48.6	1Pd	23	53.5	2Pf	12	25.0	10f	2	25.5	1Pd	20	17.5	30d	
2	27.9	2Ed*	17	6	3.0	1Ed*	12	33.5	1Pf	4	6.4	10f	21	27.2	3Pd
3	8.6	3Ed*	8	14.4	1Em	13	18.7	3Pd	4	15.5	1Pf	22	14.5	3Pf	
3	39.0	10f	14	1.2	2Ed*	14	26.6	30f	4	20.5	30d	3	0	41.0	2Ed*
3	46.3	1Pf	16	16.6	2Em	14	29.2	3Pf	5	22.6	3Pd	2	55.8	2Em	
4	43.2	2Em	17	14.2	10d	21	47.0	1Ed*	6	21.7	30f	5	14.8	1Ed*	
5	19.7	3Em	17	33.4	1Pd	23	58.1	1Em	6	22.4	3Pf	7	25.0	1Em	
6	26.7	40d	17	55.2	40d	23	34.5	2Ed*	13	7.8	2Ed*	16	22.4	10d	
7	12.9	40f	18	31.9	40f	3	49.8	2Em	13	30.9	1Ed*	16	47.6	1Pd	
12	56.3	1Ed*	19	5.6	3Ed*	5	25.5	40d	15	22.9	2Em	17	10.9	20d	
15	7.9	1Em	19	20.4	10f	5	49.1	40f	15	41.6	1Em	17	51.1	2Pd	
18	58.1	20d	19	28.5	1Pf	8	56.9	10d	29	0	39.6	10d			
19	26.0	2Pd	21	14.3	3Em	9	18.3	1Pd	1	3.0	1Pd	18	24.7	10f	
21	5.6	20f	18	4	40.3	1Ed*	11	1.9	10f	2	43.3	10f	18	34.3	1Pf
21	13.6	2Pf	6	31.4	20d	11	2.5	3Ed*	2	52.5	1Pf	18	56.4	3Ed*	
13	0	8.6	10d	6	51.7	1Em	11	10.5	1Pf	2	59.5	3Ed*	19	15.0	20f
0	26.0	1Pd	7	2.5	2Pd	13	8.2	3Em	5	1.3	3Em	19	25.4	2Pf	
1	48.4	30d	8	38.0	20f	18	4.6	20d	5	37.8	20d	4	3	52.1	1Ed*
												6	2.2	1Em	

## 1997- PHÉNOMÈNES DES SATELLITES DE SATURNE

9	34.4	2Ed*	10	56.2	3Pd	21	2.3	10d	13	20.0	10f	2	13.3	1Pd		
11	49.1	2Em	11	20.1	3Pf	21	31.0	1Pd	13	30.6	1Pf	3	38.6	10f		
14	59.5	10d	11	30.0	30f	23	1.5	10f	14	.5	2Ed*	3	49.4	1Pf		
15	25.0	1Pd	13	37.3	20d	23	11.9	1Pf	14	46.5	30d	5	22.2	3Ed		
17	1.6	10f	14	20.7	2Pd	17	0	9.3	3Ed	16	13.2	2Em	10	27.0	2Ed*	
17	11.3	1Pf	15	40.3	20f	8	34.2	1Ed*	16	37.9	30f	12	38.6	2Em		
17	36.5	30d	15	51.1	2Pf	10	3.7	20d	22	55.1	1Ed*	13	15.9	1Ed*		
18	48.9	3Pd	18	13.2	1Ed*	10	42.8	1Em	24	1	2.9	1Em	15	22.8	1Em	
19	31.5	3Pf	20	22.6	1Em	10	49.8	2Pd	6	30.0	20d					
19	35.0	30f	11	5	19.4	10d	12	5.6	20f	7	18.4	2Pd	Jui.	h	m	
5	2	4.2	20d	5	46.8	1Pd	12	16.6	2Pf	8	30.8	20f	1	0	19.4	10d
2	29.4	1Ed*	6	.9	2Ed*	19	39.4	10d	8	41.9	2Pf	8	0	50.6	1Pd	
2	45.0	2Pd	7	20.0	10f	20	8.3	1Pd	9	59.4	10d	2	2	15.5	10f	
4	8.1	20f	7	30.1	1Pf	21	38.4	10f	10	29.6	1Pd	2	2	26.3	1Pf	
4	18.5	2Pf	8	12.3	3Ed	21	48.8	1Pf	11	56.9	10f	2	2	56.3	20d	
4	39.4	1Em	8	15.0	2Em	22	49.5	30d	12	7.5	1Pf	3	4	46.4	2Pd	
13	36.7	10d	16	50.5	1Ed*	18	0	43.1	30f	13	25.2	3Ed	4	3	2.5	30d
14	2.4	1Pd	18	59.8	1Em	2	27.3	2Ed*	21	32.4	1Ed*	4	4	56.0	20f	
15	38.5	10f	22	30.6	20d	4	40.7	2Em	22	53.8	2Ed*	5	7	7.0	2Pf	
15	48.3	1Pf	23	14.5	2Pd	7	11.5	1Ed*	23	40.0	1Em	5	5	50.9	30f	
16	15.4	3Ed*	12	0	33.4	20f	9	20.0	1Em	25	1	6.3	2Em	11	53.1	1Ed*
18	27.7	2Ed*	0	44.2	2Pf	18	16.5	10d	8	36.5	10d	13	13	59.9	1Em	
20	42.3	2Em	3	56.6	10d	18	45.7	1Pd	9	6.9	1Pd	19	20	2.2	2Ed*	
6	1	6.7	1Ed*	4	24.2	1Pd	18	56.9	20d	10	33.8	10f	21	31	7	2Em
3	16.6	1Em	5	56.9	10f	19	43.5	2Pd	10	44.5	1Pf	22	22	56.6	10d	
10	57.5	20d	6	7.0	1Pf	20	15.3	10f	12	5.5	30d	23	23	27.8	1Pd	
11	39.0	2Pd	6	52.5	30d	20	25.8	1Pf	13	56.1	30f	2	0	52.5	10f	
12	13.8	10d	8	20.7	3Pd	20	58.6	20f	15	23.2	20d	1	1	3.3	1Pf	
12	39.8	1Pd	8	34.1	3Pf	21	9.6	2Pf	16	12.0	2Pd	2	2	41.2	3Ed	
13	1.2	20f	8	48.3	30f	21	28.3	3Ed	17	23.8	20f	10	30	4	1Ed*	
13	11.7	2Pf	14	54.2	2Ed*	19	5	48.8	1Ed*	17	34.9	2Pf	11	11	49.5	20d
14	15.4	10f	15	27.8	1Ed*	7	57.1	1Em	20	9.6	1Ed*	12	12	37.0	1Em	
14	25.3	1Pf	17	8.1	2Em	11	20.6	2Ed*	22	17.1	1Em	12	12	39.9	2Pd	
14	55.5	30d	17	37.0	1Em	13	33.8	2Em	26	7	13.7	10d	13	13	49.0	20f
16	10.9	3Pd	2	33.7	10d	16	53.7	10d	7	44.2	1Pd	14	14	.0	2Pf	
16	48.2	3Pf	3	1.5	1Pd	17	23.0	1Pd	7	47.1	2Ed*	21	21	33.7	10d	
16	53.3	30f	4	33.8	10f	18	52.2	10f	9	10.8	10f	22	22	5.1	1Pd	
7	23	44.0	1Ed*	4	44.0	1Pf	19	2.7	1Pf	9	21.5	1Pf	23	23	29.4	10f
1	53.8	1Em	5	31.3	3Ed	20	8.5	30d	9	59.3	2Em	23	23	40.3	1Pf	
3	21.0	2Ed*	7	23.9	20d	22	1.4	30f	10	44.2	3Ed	3	1	21.5	30d	
5	35.4	2Em	8	8.4	2Pd	3	50.2	20d	18	46.9	1Ed*	3	3	9.1	30f	
10	50.9	10d	9	26.5	20f	4	26.0	1Ed*	20	54.3	1Em	4	4	13.5	2Ed*	
11	17.2	1Pd	9	37.3	2Pf	4	37.3	2Pd	27	0	16.5	20d	6	6	24.8	2Em
12	52.3	10f	14	5.1	1Ed*	5	51.7	20f	1	5.7	2Pd	9	9	7.6	1Ed*	
13	2.2	1Pf	16	14.2	1Em	6	2.7	2Pf	2	16.9	20f	11	11	14.1	1Em	
13	34.4	3Ed	23	47.5	2Ed*	6	34.3	1Em	2	27.9	2Pf	20	20	10.9	10d	
19	50.8	20d	1	10.9	10d	15	30.8	10d	5	50.8	10d	20	20	42.3	1Pd	
20	32.9	2Pd	1	38.9	1Pd	16	.4	1Pd	6	21.5	1Pd	20	20	42.8	20d	
21	54.2	20f	2	1.3	2Em	17	29.2	10f	7	47.7	10f	21	21	33.4	2Pd	
22	4.8	2Pf	3	10.7	10f	17	39.7	1Pf	7	58.4	1Pf	22	22	6.4	10f	
22	21.3	1Ed*	3	21.0	1Pf	18	47.3	3Ed	9	24.5	30d	22	22	17.3	1Pf	
8	0	31.0	1Em	4	11.5	30d	20	13.9	2Ed*	11	14.4	30f	22	22	42.0	20f
9	28.0	10d	6	6.6	30f	22	26.9	2Em	16	40.4	2Ed*	22	22	53.1	2Pf	
9	54.6	1Pd	12	42.4	1Ed*	21	3	3.3	1Ed*	17	24.1	1Ed*	4	0	.2	3Ed
11	29.2	10f	14	51.3	1Em	5	11.4	1Em	18	52.4	2Em	7	7	44.8	1Ed*	
11	39.2	1Pf	16	17.1	20d	12	43.5	20d	19	31.4	1Em	9	9	51.2	1Em	
12	14.3	2Ed*	17	2.2	2Pd	13	31.0	2Pd	28	4	28.0	10d*	13	13	6.8	2Ed*
12	14.5	30d	18	19.5	20f	14	8.0	10d	4	58.8	1Pd*	15	15	17.8	2Em	
13	33.3	3Pd	18	30.4	2Pf	14	37.7	1Pd	6	24.7	10f*	18	18	48.1	10d	
14	4.5	3Pf	23	48.0	10d	14	44.7	20f	6	35.4	1Pf*	19	19	19.5	1Pd	
14	11.7	30f	0	16.3	1Pd	14	55.8	2Pf	8	3.2	3Ed*	20	20	43.4	10f	
14	28.6	2Em	1	47.6	10f	16	6.1	10f	9	9.8	20d*	20	20	54.2	1Pf	
20	58.6	1Ed*	1	57.9	1Pf	16	16.7	1Pf	9	59.3	2Pd*	22	22	40.5	30d	
23	8.2	1Em	2	50.3	3Ed	17	27.5	30d	11	9.9	20f*	5	0	27.3	30f	
9	4	44.1	20d	8	40.8	2Ed*	19	19.6	30f	11	21.0	2Pf*	5	5	36.0	20d
5	26.8	2Pd	10	54.4	2Em	22	1	40.6	1Ed*	16	1.4	1Ed*	6	6	22.1	1Ed*
6	47.3	20f	11	19.6	1Ed*	3	48.6	1Em	18	8.5	1Em*	6	6	26.9	2Pd	
6	58.0	2Pf	13	28.5	1Em	5	7.2	2Ed*	29	1	33.7	2Ed*	7	7	35.0	20f
8	5.2	10d	22	25.1	10d	7	20.0	2Em	3	5.1	10d	7	7	46.1	2Pf	
8	32.0	1Pd	22	53.6	1Pd	12	45.1	10d	3	36.0	1Pd	8	8	28.3	1Em	
10	6.1	10f	0	24.5	10f	13	15.0	1Pd	3	45.5	2Em	17	17	25.2	10d	
10	16.2	1Pf	0	34.9	1Pf	14	43.0	10f	5	1.6	10f	17	17	56.8	1Pd	
10	53.4	3Ed	1	10.4	20d	14	53.6	1Pf	5	12.4	1Pf	19	19	20.3	10f	
19	35.9	1Ed*	1	30.5	30d	16	6.2	3Ed	6	43.5	30d	19	19	31.2	1Pf	
21	7.6	2Ed*	1	56.0	2Pd	21	36.7	20d	8	32.6	30f	21	21	19.2	3Ed	
21	45.4	1Em	3	12.6	20f	22	24.7	2Pd	14	38.6	1Ed*	22	22	.1	2Ed*	
23	21.8	2Em	3	23.5	2Pf	23	37.8	20f	16	45.6	1Em	6	0	10.9	2Em	
10	6	42.3	10d	3	24.8	30f	23	48.8	2Pf	18	3.0	20d	4	4	59.3	1Ed*
7	9.4	1Pd	9	56.9	1Ed*	23	0	17.8	1Ed*	18	52.9	2Pd	7	7	5.4	1Em
8	43.0	10f	12	5.7	1Em	2	25.7	1Em	20	2.9	20f	14	14	29.3	20d	
8	53.1	1Pf	17	34.1	2Ed*	11	22.3	10d	20	14.0	2Pf	15	15	20.4	2Pd	
9	33.5	30d	19	47.6	2Em	11	52.3	1Pd	30	1	42.3	10d	16	16	2.4	10d

## 1997- PHÉNOMÈNES DES SATELLITES DE SATURNE

16	28.1	20f	8	16.2	10f	22	35.3	10f	12	54.5	10f	1	52.7	1Pd	
16	34.0	1Pd	8	27.1	1Pf	22	46.2	1Pf	13	5.4	1Pf	3	14.0	10f	
16	39.1	2Pf	10	35.3	3Ed	20	1	12.7	30d	13	26.6	2Em	3	24.7	1Pf
17	57.3	10f	10	55.5	20d	2	52.9	30f	15	48.6	3Ed	6	26.2	30d	
18	8.2	1Pf	11	47.1	2Pd	7	21.8	20d	22	37.7	1Ed*	7	46.0	2Ed*	
19	59.5	30d	12	53.2	20f	8	13.2	2Pd	27	0	41.1	1Em	8	.0	30f
21	45.5	30f	13	4.1	2Pf	8	17.5	1Ed*	3	48.0	20d	9	51.8	2Em	
3	36.5	1Ed*	17	57.1	1Ed*	9	18.3	20f	4	38.5	2Pd	12	57.9	1Ed*	
5	42.5	1Em	20	2.1	1Em	9	29.1	2Pf	5	43.4	20f	15	.4	1Em	
6	53.4	2Ed*	14	3	19.8	2Ed*	10	21.6	1Em	5	54.0	2Pf	3	0	10d
9	3.9	2Em	4	59.6	10d	19	19.8	10d	9	40.0	10d	0	14.3	20d	
14	39.5	10d	5	29.2	2Em	19	51.2	1Pd	10	10.6	1Pd	0	29.7	1Pd	
15	11.2	1Pd	5	31.4	1Pd	21	12.3	10f	11	31.6	10f	1	3.0	2Pd	
16	34.3	10f	6	53.2	10f	21	23.2	1Pf	11	42.4	1Pf	1	51.1	10f	
16	45.2	1Pf	7	4.1	1Pf	23	46.3	2Ed*	14	28.9	30d	2	1.8	1Pf	
18	38.2	3Ed	9	15.6	30d	23	51.4	3Ed	16	5.6	30f	2	8.5	20f	
23	22.5	20d	10	58.3	30f	21	1	54.4	2Em	20	12.8	2Ed*	2	19.0	2Pf
0	13.8	2Pd	16	34.3	1Ed*	6	54.7	1Ed*	21	14.9	1Ed*	5	5.0	3Ed	
1	21.1	20f	18	39.2	1Em	8	58.7	1Em	22	19.6	2Em	11	35.0	1Ed*	
1	32.1	2Pf	19	48.8	20d	16	15.0	20d	23	18.1	1Em	13	37.4	1Em	
2	13.8	1Ed*	20	40.4	2Pd	17	6.3	2Pd	28	8	17.2	10d	16	39.3	2Ed*
4	19.6	1Em	21	46.2	20f	17	57.0	10d	8	47.7	1Pd	18	44.8	2Em	
13	16.7	10d	21	57.1	2Pf	18	11.3	20f	10	8.6	10f	22	37.5	10d	
13	48.4	1Pd	15	3	36.8	10d	18	22.1	2Pf	10	19.5	1Pf	23	6.6	1Pd
15	11.3	10f	4	8.5	1Pd	18	28.3	1Pd	12	41.3	20d	4	0	28.2	10f
15	22.2	1Pf	5	30.2	10f	19	49.3	10f	13	7.7	3Ed	0	38.9	1Pf	
15	46.7	2Ed*	5	41.1	1Pf	20	.2	1Pf	13	31.4	2Pd	3	45.3	30d	
17	18.6	30d	7	54.3	3Ed	22	31.8	30d	14	36.4	20f	5	18.2	30f	
17	57.0	2Em	12	13.1	2Ed*	0	11.1	30f	14	47.0	2Pf	9	7.6	20d	
19	3.7	30f	14	22.3	2Em	5	31.8	1Ed*	19	52.1	1Ed*	9	55.8	2Pd	
0	51.0	1Ed*	15	11.5	1Ed*	7	35.8	1Em	21	55.2	1Em	10	12.2	1Ed*	
2	56.7	1Em	17	16.3	1Em	8	39.6	2Ed*	29	5	6.1	2Ed*	11	1.6	20f
8	15.8	20d	16	2	14.0	10d	10	47.5	2Em	6	54.4	10d	11	12.0	2Pf
9	7.2	2Pd	2	45.7	1Pd	16	34.2	10d	7	12.7	2Em	12	14.5	1Em	
10	14.1	20f	4	7.2	10f	17	5.4	1Pd	7	24.7	1Pd	21	14.7	10d	
10	25.1	2Pf	4	18.2	1Pf	18	26.4	10f	8	45.7	10f	21	43.6	1Pd	
11	53.8	10d	4	42.0	20d	18	37.3	1Pf	8	56.5	1Pf	23	5.3	10f	
12	25.6	1Pd	5	33.7	2Pd	21	10.5	3Ed	11	48.0	30d	23	15.9	1Pf	
13	48.2	10f	6	34.7	30d	1	8.3	20d	13	23.7	30f	5	1	32.6	2Ed*
13	59.2	1Pf	6	39.2	20f	1	59.4	2Pd	18	29.2	1Ed*	2	24.1	3Ed	
15	57.2	3Ed	6	50.1	2Pf	3	4.3	20f	20	32.2	1Em	3	37.9	2Em	
23	28.2	1Ed*	8	16.5	30f	3	15.0	2Pf	21	34.5	20d	8	49.3	1Ed*	
0	40.0	2Ed*	13	48.7	1Ed*	4	9.0	1Ed*	22	24.4	2Pd	10	51.5	1Em	
1	33.8	1Em	15	53.4	1Em	6	12.8	1Em	23	29.4	20f	18	.8	20d	
2	50.1	2Em	21	6.4	2Ed*	15	11.3	10d	23	40.0	2Pf	18	48.6	2Pd	
10	31.0	10d	23	15.3	2Em	15	42.4	1Pd	5	31.6	10d	19	51.9	10d	
11	2.7	1Pd	0	51.1	10d	17	3.4	10f	6	1.7	1Pd	19	54.6	20f	
12	25.2	10f	1	22.8	1Pd	17	14.3	1Pf	7	22.8	10f	20	4.9	2Pf	
12	36.2	1Pf	2	44.2	10f	17	32.9	2Ed*	7	33.6	1Pf	20	20.5	1Pd	
14	37.6	30d	2	55.2	1Pf	19	40.5	2Em	10	26.8	3Ed	21	42.4	10f	
16	21.9	30f	5	13.3	3Ed	19	50.8	30d	13	59.4	2Ed*	21	53.0	1Pf	
17	9.0	20d	12	25.9	1Ed*	21	29.2	30f	16	5.7	2Em	6	1	4.4	30d
18	.5	2Pd	13	35.3	20d	2	46.2	1Ed*	17	6.4	1Ed*	2	36.3	30f	
19	7.1	20f	14	26.9	2Pd	4	49.9	1Em	19	9.2	1Em	7	26.5	1Ed*	
19	18.1	2Pf	14	30.4	1Em	10	1.5	20d	4	8.7	10d	9	28.5	1Em	
22	5.4	1Ed*	15	32.2	20f	10	52.5	2Pd	4	38.7	1Pd	10	25.9	2Ed*	
0	10.9	1Em	15	43.1	2Pf	11	57.4	20f	5	59.8	10f	12	30.9	2Em	
9	8.2	10d	23	28.3	10d	12	8.0	2Pf	6	10.6	1Pf	18	29.0	10d	
9	33.3	2Ed*	23	59.9	1Pd	13	48.5	10d	6	27.8	20d	18	57.5	1Pd	
9	39.9	1Pd	1	21.2	10f	14	19.5	1Pd	7	17.3	2Pd	20	19.5	10f	
11	2.2	10f	1	32.2	1Pf	15	40.4	10f	8	22.5	20f	20	30.1	1Pf	
11	13.1	1Pf	3	53.7	30d	15	51.3	1Pf	8	33.0	2Pf	23	43.2	3Ed	
11	43.1	2Em	5	34.7	30f	18	29.5	3Ed	9	7.1	30d	7	2	54.1	20d
13	16.2	3Ed	5	59.7	2Ed*	1	23.4	1Ed*	10	41.9	30f	3	41.3	2Pd	
20	42.6	1Ed*	8	8.4	2Em	2	26.2	2Ed*	15	43.6	1Ed*	4	47.6	20f	
22	48.0	1Em	11	3.1	1Ed*	3	26.9	1Em	17	46.3	1Em	4	57.9	2Pf	
2	2.3	20d	13	7.5	1Em	4	33.6	2Em	22	52.7	2Ed*	6	3.6	1Ed*	
2	53.8	2Pd	22	5.5	10d	12	25.7	10d*	Août	h	m	8	5.6	1Em	
4	.2	20f	22	28.5	20d	12	56.5	1Pd*	1	0	58.8	2Em	17	6.2	10d
4	11.1	2Pf	22	37.0	1Pd	14	17.5	10f*	1	2	45.9	10d	17	34.4	1Pd
7	45.3	10d	23	20.0	2Pd	14	28.4	1Pf*	2	45.9	10d	18	56.6	10f	
8	17.1	1Pd	23	58.2	10f	17	9.9	30d*	3	15.7	1Pd	19	7.1	1Pf	
9	39.2	10f	0	9.2	1Pf	18	47.4	30f*	4	36.9	10f	19	19.3	2Ed*	
9	50.1	1Pf	0	25.3	20f	18	54.8	20d*	4	47.7	1Pf	21	23.9	2Em	
11	56.6	30d	0	36.1	2Pf	19	45.5	2Pd*	7	45.9	3Ed	22	23.5	30d	
13	40.1	30f	2	32.4	3Ed	20	50.4	20f*	14	20.7	1Ed*	23	54.4	30f	
18	26.5	2Ed*	9	40.3	1Ed*	21	1.0	2Pf*	15	21.1	20d	8	4	40.7	1Ed*
19	19.9	1Ed*	11	44.6	1Em	0	.6	1Ed*	16	10.1	2Pd	6	42.6	1Em	
20	36.2	2Em	14	53.0	2Ed*	2	4.0	1Em*	16	23.3	1Em	11	47.4	20d	
21	25.0	1Em	17	1.4	2Em	11	2.8	10d	17	15.5	20f	12	34.0	2Pd	
6	22.5	10d	20	42.6	10d	11	19.5	2Ed*	17	26.0	2Pf	13	40.6	20f	
6	54.2	1Pd	21	14.1	1Pd	11	33.6	1Pd	2	1	23.1	10d	13	50.9	2Pf

## 1997- PHÉNOMÈNES DES SATELLITES DE SATURNE

15	43.4	10d	8	13.7	20d	22	23.4	1Pf*	12	43.2	1Pf	2	54.7	10f		
16	11.4	1Pd	8	57.2	2Pd	22	16.7	3Ed*	16	54.6	30d	3	3.0	1Pf		
17	33.7	10f	10	5.8	20f	22	4	40.2	20d*	18	13.7	30f	5	6.2	2Ed*	
17	44.2	1Pf	10	15.8	2Pf	5	19.8	2Pd*	22	17.2	1Ed*	7	4.2	2Em		
21	2.4	3Ed	11	40.1	30d	6	31.1	20f*	29	0	16.7	1Em	7	31.7	3Ed*	
3	17.9	1Ed*	13	7.0	30f	6	40.7	2Pf*	1	6.7	20d	12	36.8	1Ed*		
4	12.6	2Ed*	17	37.8	1Ed*	7	57.5	1Ed*	1	41.8	2Pd	14	35.5	1Em		
5	19.6	1Em	19	38.7	1Em	9	57.8	1Em	2	56.3	20f	21	33.3	20d		
6	17.0	2Em	0	39.2	2Ed*	19	1.5	10d	3	5.6	2Pf	22	3.3	2Pd		
14	20.6	10d	2	42.1	2Em	19	24.7	1Pd	9	22.0	10d	23	21.7	20f		
14	48.3	1Pd	4	41.0	10d	20	50.9	10f	9	42.5	1Pd	23	30.3	2Pf		
16	10.8	10f	5	6.6	1Pd	21	.5	1Pf	11	11.3	10f	23	42.6	10d		
16	21.3	1Pf	6	30.7	10f	21	5.9	2Ed*	11	20.3	1Pf	5	0	.2	1Pd	
19	42.6	30d	6	40.9	1Pf	23	7.2	2Em	15	33.7	3Ed*	1	31.9	10f		
20	40.6	20d	10	19.0	3Ed*	0	56.8	30d	17	32.7	2Ed*	1	40.1	1Pf		
21	12.6	30f	16	14.9	1Ed*	2	19.4	30f	19	32.2	2Em	6	11.8	30d		
21	26.7	2Pd	17	7.0	20d	6	34.6	1Ed*	20	54.3	1Ed*	7	26.0	30f		
22	33.7	20f	17	49.8	2Pd	8	34.8	1Em	22	53.7	1Em	11	13.9	1Ed*		
22	43.9	2Pf	18	15.8	1Em	13	33.5	20d	30	7	59.2	10d	13	12.5	1Em	
10	3	55.0	1Ed*	18	58.9	20f	14	12.2	2Pd	8	19.4	1Pd	13	59.6	2Ed*	
3	56.6	1Em	19	8.8	2Pf	15	24.1	20f	9	48.5	10f	15	57.1	2Em		
12	57.8	10d	3	18.2	10d	15	33.7	2Pf	9	57.4	1Pf	22	19.9	10d		
13	5.9	2Ed*	3	43.5	1Pd	17	38.7	10d	9	60.0	20d	22	37.0	1Pd		
13	25.2	1Pd	5	7.9	10f	18	1.6	1Pd	10	34.1	2Pd	6	0	9.1	10f	
14	47.9	10f	5	18.0	1Pf	19	28.1	10f	11	49.4	20f	0	17.2	1Pf		
14	58.4	1Pf	8	59.2	30d	19	37.7	1Pf	11	58.5	2Pf	4	51.1	3Ed*		
15	10.0	2Em	9	32.5	2Ed*	23	35.9	3Ed*	14	13.8	30d	6	26.6	20d		
18	21.5	3Ed	10	25.1	30f	5	11.7	1Ed*	15	31.8	30f	6	55.5	2Pd		
11	0	32.2	1Ed*	11	35.1	2Em	5	59.3	2Ed*	19	31.4	1Ed*	8	14.8	20f	
2	33.7	1Em	14	52.0	1Ed*	7	11.8	1Em	21	30.7	1Em	8	23.2	2Pf		
5	33.9	20d	16	52.8	1Em	8	.2	2Em	31	2	26.1	2Ed*	9	50.9	1Ed*	
6	19.4	2Pd	1	55.4	10d	16	15.9	10d	4	25.2	2Em	11	49.4	1Em		
7	26.7	20f	2	.3	20d	16	38.4	1Pd	6	36.5	10d	20	57.1	10d		
7	36.9	2Pf	2	20.4	1Pd	18	5.3	10f	6	56.2	1Pd	21	13.8	1Pd		
11	35.0	10d	2	42.3	2Pd	18	14.8	1Pf	8	25.7	10f	22	46.4	10f		
12	2.2	1Pd	3	45.0	10f	22	16.1	30d	8	34.5	1Pf	22	53.0	2Ed*		
13	25.0	10f	3	51.9	20f	22	26.8	20d	12	53.1	3Ed*	22	54.4	1Pf		
13	35.4	1Pf	3	55.0	1Pf	23	4.6	2Pd	18	8.5	1Ed*	7	0	50.1	2Em	
17	1.8	30d	4	1.8	2Pf	23	37.5	30f	18	53.3	20d	3	31.2	30d		
18	30.7	30f	7	38.2	3Ed*	0	17.2	20f	19	26.4	2Pd	4	44.1	30f		
21	59.2	2Ed*	13	29.1	1Ed*	0	26.7	2Pf	20	7.6	1Em	8	28.0	1Ed*		
12	23	9.3	1Ed*	15	29.8	1Em	3	48.8	1Ed*	20	42.5	20f	10	26.4	1Em	
0	3.0	2Em	18	25.9	2Ed*	5	48.8	1Em	20	51.5	2Pf	15	20.0	20d		
1	10.7	1Em	20	28.1	2Em	14	52.6	2Ed*	15	47.8	2Pd	15	47.8	2Pd		
10	12.2	10d	0	32.6	10d	14	53.1	10d	Sep.	h	m	17	7.9	20f		
10	39.1	1Pd	0	57.3	1Pd	15	15.2	1Pd	1	5	13.7	10d	17	16.2	2Pf	
12	2.2	10f	2	22.2	10f	16	42.5	10f	1	5	33.0	1Pd	19	34.4	10d	
12	12.5	1Pf	2	32.1	1Pf	16	51.9	1Pf	7	3.0	10f	19	50.6	1Pd		
14	27.2	20d	6	18.4	30d	16	53.2	2Em	7	11.6	1Pf	21	23.7	10f		
15	12.0	2Pd	7	43.2	30f	20	55.2	3Ed*	11	19.5	2Ed*	21	31.5	1Pf		
15	40.7	3Ed	10	53.6	20d	2	25.9	1Ed*	11	33.1	30d	2	10.5	3Ed*		
16	19.7	20f	11	34.8	2Pd	4	25.7	1Em	12	49.9	30f	7	5.1	1Ed*		
16	29.9	2Pf	12	6.2	1Ed*	7	20.1	20d	13	18.2	2Em	7	46.4	2Ed*		
21	46.4	1Ed*	12	45.0	20f	7	57.0	2Pd	16	45.5	1Ed*	9	3.3	1Em		
23	47.7	1Em	12	54.8	2Pf	9	10.2	20f	18	44.6	1Em	9	43.1	2Em		
13	6	52.5	2Ed*	14	6.8	1Em	9	19.6	2Pf	2	3	46.6	20d	18	11.6	10d
8	49.4	10d	23	9.8	10d	13	30.3	10d	3	50.9	10d	18	27.4	1Pd		
8	56.0	2Em	23	34.1	1Pd	13	52.1	1Pd	4	9.8	1Pd	20	.9	10f		
9	16.0	1Pd	0	59.4	10f	15	19.7	10f	4	18.7	2Pd	20	8.6	1Pf		
10	39.3	10f	1	9.2	1Pf	15	29.0	1Pf	5	35.6	20f	9	0	13.3	20d	
10	49.6	1Pf	3	19.2	2Ed*	19	35.3	30d	5	40.2	10f	0	40.0	2Pd		
14	20.9	30d	4	57.4	3Ed*	20	55.6	30f	5	44.4	2Pf	0	50.5	30d		
15	48.8	30f	5	21.2	2Em	23	46.0	2Ed*	5	48.8	1Pf	2	1.0	20f		
20	23.5	1Ed*	10	43.3	1Ed*	1	3.0	1Ed*	10	12.4	3Ed*	2	2.1	30f		
22	24.7	1Em	12	43.8	1Em	1	46.2	2Em	15	22.6	1Ed*	2	9.1	2Pf		
23	20.5	20d	19	46.9	20d	3	2.7	1Em	17	21.6	1Em	5	42.1	1Ed*		
14	0	4.6	2Pd	20	27.3	2Pd	12	7.6	10d	20	12.8	2Ed*	7	40.3	1Em	
1	12.8	20f	21	38.0	20f	12	28.9	1Pd	22	11.2	2Em	16	39.8	2Ed*		
1	22.9	2Pf	21	47.0	10d	13	56.9	10f	3	2	28.2	10d	16	48.8	10d	
7	26.6	10d	21	47.8	2Pf	14	6.1	1Pf	2	46.6	1Pd	17	4.2	1Pd		
7	52.9	1Pd	22	11.0	1Pd	16	13.4	20d	4	17.4	10f	18	36.1	2Em		
9	16.4	10f	23	36.5	10f	16	49.4	2Pd	4	25.9	1Pf	18	38.2	10f		
9	26.7	1Pf	23	46.3	1Pf	18	3.3	20f	8	52.5	30d	18	45.7	1Pf		
12	59.8	3Ed	3	37.6	30d	18	12.6	2Pf	10	7.9	30f	23	29.9	3Ed*		
15	45.9	2Ed*	5	1.3	30f	18	14.5	3Ed*	12	39.9	20d	10	4	19.2	1Ed*	
17	49.1	2Em	9	20.4	1Ed*	23	40.1	1Ed*	13	11.0	2Pd	6	17.2	1Em		
19	.7	1Ed*	11	20.8	1Em	1	39.7	1Em	13	59.7	1Ed*	9	6.6	20d		
21	1.7	1Em	12	12.6	2Ed*	8	39.4	2Ed*	14	28.6	20f	9	32.2	2Pd		
15	6	3.8	10d	14	14.2	2Em	10	39.2	2Em	14	37.4	2Pf	10	54.1	20f	
6	29.8	1Pd	20	24.3	10d*	10	44.8	10d	15	58.5	1Em	11	2.0	2Pf		
7	53.6	10f	20	47.9	1Pd*	11	5.7	1Pd	4	1	5.4	10d	15	26.1	10d	
8	3.8	1Pf	22	13.7	10f*	12	34.1	10f	1	23.4	1Pd	15	41.0	1Pd		

## 1997- PHÉNOMÈNES DES SATELLITES DE SATURNE

11	17	15.5	10f	7	26.6	2Pf	3	45.2	20f	9	6.2	10d	1	19.8	1Pf		
	17	22.9	1Pf	7	36.5	10f	3	51.1	2Pf	9	10.4	1Pd	7	22.6	3Im		
	22	9.9	30d	7	42.8	1Pf	3	58.9	3Pd	10	56.5	10f	8	17.7	3Em		
	23	20.2	30f	12	47.8	3Ed*	4	20.3	3Pf	10	59.8	1Pf	12	44.8	1Em		
	1	33.2	2Ed*	17	15.7	1Ed*	4	26.2	30f	16	43.1	2Em	13	7.7	2Em		
	2	56.3	1Ed*	19	12.7	1Em	9	31.2	1Em	16	45.4	30d	22	4.7	10d		
	3	29.0	2Em	22	.3	2Ed*	18	45.1	10d	16	57.9	3Pd	22	4.9	1Pd		
	4	54.2	1Em	23	53.8	2Em	18	52.8	1Pd	17	37.9	30f	23	55.5	10f		
	14	3.3	10d	18	4	24.2	10d*	20	18.5	2Em	17	40.5	3Pf	23	57.0	1Pf	
	14	17.8	1Pd	4	35.3	1Pd*	20	35.0	10f	22	26.5	1Em	9	3	47.9	2Pd	
	15	52.7	10f	6	13.8	10f*	20	39.8	1Pf	2	7	21.0	20d	3	48.3	20d	
	15	60.0	1Pf	6	19.9	1Pf*	25	8	8.1	1Em	7	27.0	2Pd	5	29.9	20f	
	18	.0	20d	11	27.8	30d*	10	53.8	20d	7	43.5	10d	5	32.7	2Pf		
	18	24.5	2Pd	12	32.3	30f*	11	6.2	2Pd	7	47.2	1Pd	6	.6	3Pd		
	19	47.2	20f	14	26.8	20d*	12	38.3	20f	9	4.0	20f	6	5.1	30d		
	19	55.0	2Pf	14	45.4	2Pd*	12	44.0	2Pf	9	8.4	2Pf	6	49.0	30f		
	20	49.4	3Ed*	15	52.8	1Ed*	17	22.4	10d	9	33.8	10f	6	57.0	3Pf		
12	1	33.3	1Ed*	16	12.7	20f*	17	29.6	1Pd	9	36.9	1Pf	9	28.0	1Im		
	3	31.1	1Em	16	19.5	2Pf*	19	12.4	10f	16	20.4	3Em	11	21.7	1Em		
	10	26.6	2Ed*	17	49.7	1Em	19	17.0	1Pf	21	3.4	1Em	20	15.0	2Im		
	12	22.0	2Em	19	3	1.4	10d	26	0	46.2	30d	3	1	36.0	2Em		
	12	40.6	10d	3	12.0	1Pd	1	12.9	3Pd	6	20.8	10d	20	42.0	10d		
	12	54.5	1Pd	4	51.1	10f	1	41.1	3Pf	6	24.0	1Pd	22	.6	2Em		
	14	30.0	10f	4	57.0	1Pf	1	44.2	30f	8	11.2	10f	22	32.8	10f		
	14	37.1	1Pf	6	53.7	2Ed*	5	11.4	2Em	8	14.1	1Pf	22	34.1	1Pf		
	19	29.4	30d	8	46.7	2Em	6	45.0	1Em	14	5.3	30d	10	4	38.5	3Im	
	20	38.2	30f	10	7.4	3Ed*	15	59.7	10d	14	13.4	3Pd	5	36.5	3Em		
13	0	10.4	1Ed*	14	29.8	1Ed*	16	6.4	1Pd	14	55.7	30f	8	4.5	1Im		
	2	8.1	1Em	16	26.6	1Em	17	49.7	10f	14	59.8	3Pf	9	58.6	1Em		
	2	53.4	20d	23	20.2	20d	17	54.1	1Pf	16	14.4	20d	12	40.1	2Pd		
	3	16.7	2Pd	23	37.6	2Pd	19	47.3	20d	16	19.2	2Pd	12	41.8	20d		
	4	40.3	20f	1	5.8	20f	19	58.4	2Pd	17	57.2	20f	14	23.1	20f		
	4	47.9	2Pf	1	12.4	2Pf	21	31.5	20f	18	1.2	2Pf	14	25.6	2Pf		
	11	17.9	10d	1	38.7	10d	21	36.9	2Pf	19	40.3	1Em	19	18.6	1Pd		
	11	31.3	1Pd	1	48.8	1Pd	27	5	21.9	1Em	4	58.1	10d	19	19.3	10d	
	13	7.3	10f	3	28.4	10f	14	4.3	2Em	5	.8	1Pd	21	10.2	10f		
	13	14.2	1Pf	3	34.2	1Pf	14	37.0	10d	6	48.6	10f	21	11.3	1Pf		
	18	8.8	3Ed*	8	47.4	30d	14	43.2	1Pd	6	51.2	1Pf	11	3	16.6	3Pd	
	19	20.0	2Ed*	9	50.3	30f	16	27.1	10f	10	28.9	2Em	3	25.2	30d		
	21	14.9	2Em	15	3.5	1Em	16	31.2	1Pf	13	39.6	3Em	4	6.7	30f		
14	22	47.5	1Ed*	15	47.2	2Ed*	22	5.9	30d	18	17.2	1Em	4	15.8	3Pf		
	0	45.0	1Em	17	39.7	2Em	22	27.6	3Pd	5	1	7.9	20d	5	7.3	2Im	
	9	55.1	10d	21	0	16.0	10d	23	1.3	3Pf	1	11.4	2Pd	6	41.0	1Im	
	10	8.1	1Pd	0	25.6	1Pd	23	2.1	30f	2	50.4	20f	6	53.5	2Em		
	11	44.6	10f	2	5.7	10f	28	3	58.9	1Em	2	54.1	2Pf	8	35.5	1Em	
	11	46.7	20d	2	11.3	1Pf	4	40.7	20d	3	35.4	10d	17	55.4	1Pd		
	11	51.4	1Pf	7	27.0	3Ed*	4	50.5	2Pd	3	37.6	1Pd	17	56.6	10d		
	12	8.8	2Pd	8	13.6	20d	6	24.6	20f	5	25.9	10f	19	47.6	10f		
	13	33.4	20f	8	29.7	2Pd	6	29.7	2Pf	5	28.4	1Pf	19	48.4	1Pf		
	13	40.8	2Pf	9	58.9	20f	13	14.3	10d	11	25.2	30d	21	32.4	2Pd		
	16	48.8	30d	10	5.3	2Pf	13	20.0	1Pd	11	29.0	3Pd	21	35.2	20d		
	17	56.3	30f	13	40.4	1Em	15	4.4	10f	12	13.5	30f	23	16.2	20f		
	21	24.5	1Ed*	22	53.3	10d	15	8.4	1Pf	12	19.0	3Pf	23	18.5	2Pf		
15	23	21.9	1Em	23	2.4	1Pd	21	41.4	3Em	16	54.1	1Em	12	1	54.5	3Im	
	4	13.4	2Ed*	22	0	40.6	2Ed*	22	57.3	2Em	19	21.8	2Em	2	55.3	3Em	
	6	7.9	2Em	0	43.0	10f	29	2	35.8	1Em	6	2	12.7	10d	5	17.5	1Im
	8	32.4	10d	0	48.4	1Pf	11	51.6	10d	2	14.4	1Pd	7	12.4	1Em		
	8	44.9	1Pd	2	32.6	2Em	11	56.8	1Pd	4	3.3	10f	13	59.6	2Im		
	10	21.9	10f	6	7.0	30d	13	34.1	20d	4	5.5	1Pf	15	46.4	2Em		
	10	28.5	1Pf	6	46.6	3Pd	13	41.8	10f	10	1.3	20d	16	32.2	1Pd		
	15	28.3	3Ed*	6	57.8	3Pf	13	42.7	2Pd	10	3.5	2Pd	16	34.0	10d		
	20	1.6	1Ed*	7	8.3	30f	13	45.5	1Pf	10	58.7	3Em	18	25.0	10f		
	20	40.1	20d	12	17.4	1Em	15	17.7	20f	11	43.5	20f	18	25.6	1Pf		
	21	1.0	2Pd	17	7.0	20d	15	22.6	2Pf	11	47.0	2Pf	13	0	32.7	3Pd	
	21	58.9	1Em	17	21.9	2Pd	19	25.7	30d	15	31.0	1Em	0	45.4	30d		
	22	26.5	20f	18	52.0	20f	19	42.6	3Pd	7	0	50.0	10d	1	24.3	30f	
	22	33.7	2Pf	18	58.2	2Pf	20	20.0	30f	0	51.2	1Pd	1	34.6	3Pf		
16	7	9.6	10d	21	30.5	10d	20	21.0	3Pf	2	40.7	10f	3	54.1	1Im		
	7	21.7	1Pd	21	39.2	1Pd	1	12.7	1Em	2	42.7	1Pf	5	49.3	1Em		
	8	59.2	10f	23	20.4	10f	7	50.2	2Em	4	14.8	2Em	6	24.6	2Pd		
	9	5.6	1Pf	23	25.6	1Pf	10	28.9	10d	8	44.8	3Pd	6	28.7	20d		
	13	6.9	2Ed*	23	4	46.6	3Ed*	10	33.6	1Pd	8	45.1	30d	8	9.4	20f	
	14	8.3	30d	9	34.1	2Ed*	12	19.1	10f	9	31.3	30f	8	11.3	2Pf		
	15	.9	2Em	10	54.3	1Em	12	22.7	1Pf	9	38.0	3Pf	15	9.1	1Pd		
	15	14.3	30f	11	25.5	2Em	19	1.0	3Em	14	7.9	1Em	15	11.3	10d		
	18	38.7	1Ed*	20	7.8	10d	22	27.5	20d	18	54.8	20d	17	2.4	10f		
	20	35.8	1Em	20	16.0	1Pd	22	34.8	2Pd	18	55.7	2Pd	17	2.8	1Pf		
17	5	33.5	20d	21	57.7	10f	23	49.6	1Em	20	36.7	20f	22	51.9	2Im		
	5	46.9	10d	22	2.7	1Pf	Oct.	h		20	39.9	2Pf	23	10.6	3Im		
	5	53.2	2Pd	24	.4	20d	1	0	10.9	20f	23	27.3	10d	14	0	14.1	3Em
	5	58.5	1Pd	2	14.0	2Pd	1	0	15.5	2Pf	8	23	28.1	1Pd	0	39.3	2Em
	7	19.6	20f	3	26.6	30d	0	0	15.5	2Pf	8	1	18.1	10f	2	30.6	1Im



## 1997- PHÉNOMÈNES DES SATELLITES DE SATURNE

4	26.2	1Em	13	37.8	3Pd	4	5.6	3Im	10	45.8	10f	23	45.4	10f			
13	46.0	1Pd	14	7.6	30d	5	24.0	3Em	11	58.1	2Im	11	0	45.2	2Pd		
13	48.6	10d	14	33.4	30f	7	2.5	1Im	17	12.9	3Im	1	13.3	20d			
15	16.8	2Pd	14	49.1	3Pf	15	35.6	2Im	18	37.6	3Em	2	42.3	2Pf			
15	22.2	20d	16	46.5	1Im	18	22.4	1Pd	19	55.6	1Im	2	47.3	20f			
15	39.8	10f	19	13.6	2Im	18	31.5	10d	4	22.3	2Pd	6	21.5	3Im			
15	39.9	1Pf	4	4.1	1Pd	20	20.4	1Pf	4	45.3	20d	7	51.0	3Em			
17	2.6	20f	4	10.0	10d	20	23.7	10f	6	17.6	2Pf	8	49.2	1Im			
17	4.2	2Pf	6	.1	1Pf	28	2	44.1	3Pd	6	21.0	20f	17	13.8	2Im		
21	48.8	3Pd	6	1.7	10f	4	3.1	3Pf	7	18.0	1Pd	20	14.0	1Pd*			
22	5.7	30d	11	38.2	2Pd	5	39.2	1Im	7	30.4	10d	20	29.4	10d*			
22	41.8	30f	11	49.8	20d	8	.0	2Pd	9	17.9	1Pf	22	15.7	1Pf*			
22	53.3	3Pf	12	15.9	3Im	8	17.5	20d	9	23.3	10f	22	22.9	10f*			
15	1	7.1	1Im	13	28.5	3Em	9	53.0	2Pf	15	51.7	3Pd	12	5	.5	3Pd*	
3	3.1	1Em	13	28.6	2Pf	9	54.8	20f	17	16.7	3Pf	6	30.1	3Pf*			
7	44.2	2Im	13	28.6	20f	16	59.3	1Pd	18	32.3	1Im	7	25.9	1Im*			
9	32.2	2Em	15	23.0	1Im	17	8.8	10d	20	50.7	2Im	9	37.8	2Pd			
12	22.8	1Pd*	2	40.9	1Pd	18	57.5	1Pf	5	55.0	1Pd	10	6.9	20d			
12	26.0	10d*	2	47.3	10d	19	1.2	10f	6	7.8	10d	11	35.3	2Pf			
14	17.1	1Pf*	4	6.0	2Im	29	0	28.1	2Im	7	55.1	1Pf	11	40.6	20f		
14	17.2	10f*	4	37.3	1Pf	1	22.3	3Im	8	.7	10f	18	51.1	1Pd			
20	26.8	3Im*	4	39.1	10f	2	42.4	3Em	13	14.9	2Pd	19	6.8	10d			
21	32.8	3Em*	10	54.2	3Pd	4	15.8	1Im	13	38.9	20d	20	52.9	1Pf			
23	43.7	1Im*	11	28.8	30d	15	36.3	1Pd	14	29.9	3Im	21	.4	10f			
16	0	9.1	2Pd*	11	50.1	30f	15	46.2	10d	15	10.5	2Pf	13	2	6.5	2Im	
0	15.7	20d*	12	7.7	3Pf	16	52.5	2Pd	16	14.3	20f	15	3	38.8	3Im		
1	55.8	20f	13	59.6	1Im	17	11.0	20d	17	56.0	3Em	5	9.4	3Em			
1	57.1	2Pf	20	30.6	2Pd	17	34.7	1Pf	17	9.0	1Im	6	2.7	1Im			
10	59.7	1Pd	20	43.3	20d	17	38.6	10f	6	4	32.0	1Pd	17	28.1	1Pd		
11	3.3	10d	22	21.5	2Pf	18	45.9	2Pf	4	45.1	10d	17	44.2	10d			
12	54.2	1Pf	22	21.9	20f	18	48.0	20f	5	43.3	2Im	18	30.5	2Pd			
12	54.6	10f	23	17.8	1Pd	30	0	.9	3Pd	6	32.4	1Pf	19	.5	20d		
16	36.5	2Im	1	24.7	10d	1	21.5	3Pf	6	38.2	10f	19	30.2	1Pf			
18	25.2	2Em	3	14.4	1Pf	2	52.4	1Im	13	8.7	3Pd	19	37.8	10f			
19	5.1	3Pd	3	16.6	10f	9	20.6	2Im	14	35.0	3Pf	20	28.3	2Pf			
19	26.2	30d	9	32.4	3Im	14	13.2	1Pd	15	45.6	1Im	20	33.9	20f			
19	59.2	30f	10	47.0	3Em	14	23.5	10d	22	7.4	2Pd	14	2	17.8	3Pd		
20	11.9	3Pf	12	36.2	1Im	16	11.9	1Pf	22	32.5	20d	3	48.5	3Pf			
22	20.2	1Im	12	58.4	2Im	16	16.0	10f	7	0	3.5	2Pf	4	39.4	1Im		
17	9	1.4	2Pd	23	54.7	1Pd	22	39.1	3Im	0	7.5	20f	10	59.2	2Im		
9	9.2	20d	24	0	2.0	10d	31	0	.8	3Em	3	9.0	1Pd	16	5.1	1Pd	
9	36.5	1Pd	1	51.6	1Pf	1	29.0	1Im	1	29.0	1Im	3	22.5	10d	16	21.6	10d
9	40.6	10d	1	54.0	10f	1	44.9	2Pd	5	9.6	1Pf	5	9.6	1Pf	18	7.4	1Pf
10	49.0	20f	5	22.9	2Pd	2	4.6	20d	5	15.6	10f	5	15.6	10f	18	15.3	10f
10	49.9	2Pf	5	36.8	20d	3	38.8	2Pf	11	47.0	3Im	15	0	56.2	3Im		
11	31.4	1Pf	7	14.3	2Pf	3	41.3	20f	13	14.3	3Em	2	27.7	3Em			
11	32.1	10f	7	15.1	20f	12	50.2	1Pd	14	22.3	1Im	3	16.2	1Im			
17	43.1	3Im	8	10.8	3Pd	13	.9	10d	14	35.9	2Im	3	23.1	2Pd			
18	51.4	3Em	8	50.6	3Ed	14	49.1	1Pf	8	1	46.0	1Pd	3	54.1	20d		
20	56.8	1Im	9	6.2	3Ed	14	53.5	10f	1	59.9	10d	5	21.3	2Pf			
18	1	28.9	2Im	9	26.2	3Pf	18	13.1	2Im	3	46.8	1Pf	5	27.2	20f		
3	18.1	2Em	11	12.8	1Im	21	17.7	3Pd	3	53.1	10f	14	42.2	1Pd			
8	13.4	1Pd	21	50.8	2Im	22	39.9	3Pf	6	60.0	2Pd	14	59.0	10d			
8	18.0	10d	22	31.6	1Pd	Nov.	h	m	7	26.1	20d	16	44.6	1Pf			
10	8.6	1Pf	22	39.4	10d	1	0	5.7	1Im	8	56.4	2Pf	16	52.7	10f		
10	9.5	10f	25	0	28.8	1Pf	10	37.4	2Pd	9	.8	20f	19	52.0	2Im		
16	21.4	3Pd	0	31.4	10f	10	58.2	20d	10	25.9	3Pd	23	35.3	3Pd			
16	46.8	30d	6	48.9	3Im	10	58.2	20d	11	53.4	3Pf	16	1	6.8	3Pf		
17	16.4	30f	8	5.5	3Em	11	27.1	1Pd	12	59.0	1Im	1	53.0	1Im			
17	30.6	3Pf	9	49.3	1Im	11	38.3	10d	23	28.5	2Im	12	15.9	2Pd			
17	53.6	2Pd	14	15.3	2Pd	12	31.7	2Pf	9	0	23.0	1Pd	12	47.7	20d		
18	2.7	20d	14	30.4	20d	12	34.5	20f	0	37.3	10d	13	19.2	1Pd			
19	33.3	1Im	16	7.2	2Pf	13	26.3	1Pf	2	24.0	1Pf	13	36.3	10d			
19	42.2	20f	16	8.3	20f	13	30.9	10f	2	30.5	10f	14	14.3	2Pf			
19	42.8	2Pf	21	8.6	1Pd	19	56.0	3Im	9	4.2	3Im	14	20.4	20f			
19	6	50.3	1Pd	21	16.7	10d	21	19.2	3Em	10	32.7	3Em	15	21.9	1Pf		
6	55.3	10d	23	6.0	1Pf	22	42.3	1Im	11	35.7	1Im	15	30.2	10f			
8	45.7	1Pf	23	8.9	10f	2	3	5.6	2Im	15	52.6	2Pd	22	13.7	3Im		
8	46.9	10f	26	5	27.4	3Pd	10	4.1	1Pd	16	19.7	20d	23	46.1	3Em		
10	21.2	2Im	6	14.7	30d	10	15.6	10d	10	15.6	10d	17	0	29.7	1Im		
12	11.0	2Em	6	20.0	30f	12	3.5	1Pf	17	49.4	2Pf	2	44.3	1Ef*			
14	59.4	3Im	6	43.2	2Im	12	8.4	10f	22	60.0	1Pd	4	44.7	2Im			
16	10.0	3Em	6	44.6	3Pf	18	34.7	3Pd	23	14.6	10d	11	56.3	1Pd			
18	9.9	1Im	8	25.9	1Im	19	29.8	2Pd	10	1	1.2	1Pf	12	13.7	10d		
2	45.9	2Pd	19	45.5	1Pd	19	51.7	20d	1	8.0	10f	13	59.1	1Pf			
2	56.3	20d	19	54.1	10d	19	58.3	3Pf	7	43.1	3Pd	14	7.7	10f			
4	35.4	20f	21	43.2	1Pf	21	19.0	1Im	8	21.2	2Im	20	52.9	3Pd			
4	35.7	2Pf	21	46.3	10f	21	24.7	2Pf	9	11.8	3Pf	21	8.6	2Pd			
5	27.2	1Pd	23	7.7	2Pd	21	27.8	20f	10	12.5	1Im	21	41.4	20d			
5	32.6	10d	23	23.9	20d	3	8	41.0	1Pd	21	37.0	1Pd	22	25.2	3Pf		
7	22.9	1Pf	27	1	.1	2Pf	8	53.0	10d	21	52.0	10d	23	6.5	1Im		
7	24.3	10f	1	1.5	20f	10	40.7	1Pf	23	38.5	1Pf	23	7.3	2Pf			

## 1997- PHÉNOMÈNES DES SATELLITES DE SATURNE

18	23	13.7	20f		19	40.2	20f	15	13.0	1Pd	7	51.7	10f	15	5	45.9	3Im	
	1	21.5	1Ef*	25	0	53.0	1Pd	15	34.7	10d	10	22.7	2Pd		6	48.7	2Pd	
	10	33.4	1Pd		1	12.9	10d	15	57.9	2Pf	11	6.3	20d		6	58.0	1Im	
	10	51.1	10d		2	57.2	1Pf	16	6.7	20f	12	23.6	2Pf		7	22.0	3Em	
	12	36.4	1Pf		3	7.3	10f	17	18.2	1Pf	12	33.3	20f		7	34.8	20d	
	12	45.1	10f		10	1.8	2Im	17	29.6	10f	15	11.3	3Pd		8	49.5	2Pf	
	13	37.5	2Im		10	3.9	3Pd	2	0	36.5	3Im	16	38.6	1Im		8	59.9	20f
	19	31.2	3Im		11	38.6	3Pf	2	13.0	3Em	16	47.4	3Pf		9	21.2	1Ef*	
	21	4.4	3Em		12	1.2	1Im	2	19.6	1Im	19	.5	1Ef*		18	31.2	1Pd	
	21	43.3	1Im		14	19.3	1Ef*	4	39.8	1Ef*	9	2	52.4	2Im*	18	55.7	10d	
	23	58.7	1Ef*		23	30.2	1Pd	6	26.8	2Im	4	10.6	1Pd*		20	38.0	1Pf	
19	6	1.3	2Pd		23	50.3	10d	13	50.2	1Pd	4	33.9	10d*		20	51.3	10f	
	6	35.0	20d	26	1	34.5	1Pf	14	12.1	10d	6	16.7	1Pf*		23	18.6	2Im	
	8	.3	2Pf		1	44.8	10f	15	55.5	1Pf	6	29.2	10f*	16	4	26.0	3Pd	
	8	7.0	20f		2	25.5	2Pd	16	7.0	10f	13	49.9	3Im*		5	35.1	1Im	
	9	10.5	1Pd		3	3.2	20d	22	50.4	2Pd	15	15.6	1Im		6	1.1	3Pf	
	9	28.5	10d		4	25.5	2Pf	23	16.2	3Pd	15	26.7	3Em		7	58.4	1Ef*	
	11	13.6	1Pf		4	33.5	20f	23	31.6	20d	17	37.7	1Ef*		15	42.0	2Pd	
	11	22.6	10f		8	42.3	3Im	3	0	51.0	2Pf	19	15.9	2Pd		16	28.5	20d
	18	10.5	3Pd		10	17.9	3Em	0	52.1	3Pf	19	60.0	20d		17	8.5	1Pd	
	19	43.5	3Pf		10	38.1	1Im	0	56.6	1Im	21	16.7	2Pf		17	33.2	10d	
	20	20.2	1Im		12	56.5	1Ef*	1	.0	20f	21	26.6	20f		17	42.8	2Pf	
	22	30.3	2Im		18	54.8	2Im	3	17.1	1Ef*	10	2	47.8	1Pd		17	53.2	20f
	22	36.0	1Ef*		22	7.3	1Pd	12	27.4	1Pd	3	11.3	10d		19	15.3	1Pf	
20	7	47.5	1Pd		22	27.7	10d	12	49.5	10d	4	54.0	1Pf		19	28.7	10f	
	8	5.9	10d	27	0	11.8	1Pf	14	32.8	1Pf	5	6.6	10f	17	3	4.7	3Im	
	9	50.9	1Pf		0	22.3	10f	14	44.5	10f	11	45.6	2Im		4	12.2	1Im	
	10	.0	10f		7	21.8	3Pd	15	19.8	2Im	12	29.9	3Pd		4	40.5	3Em	
	14	54.1	2Pd		8	57.0	3Pf	21	54.7	3Im	13	52.6	1Im		6	35.7	1Ef*	
	15	28.6	20d		9	15.0	1Im	23	31.4	3Em	14	5.8	3Pf		8	12.0	2Im	
	16	48.9	3Im		11	18.4	2Pd	23	33.6	1Im	16	15.0	1Ef*		15	45.7	1Pd	
	16	53.3	2Pf		11	33.7	1Ef*	1	54.3	1Ef*	11	1	25.0	1Pd		16	10.6	10d
	17	.3	20f		11	56.9	20d	7	43.4	2Pd	1	48.7	10d		17	52.6	1Pf	
	18	22.8	3Em		13	18.6	2Pf	8	25.2	20d	3	31.3	1Pf		18	6.2	10f	
	18	57.0	1Im		13	26.8	20f	9	44.1	2Pf	3	44.1	10f	18	0	35.3	2Pd	
	21	13.2	1Ef*		20	44.4	1Pd	9	53.3	20f	4	9.0	2Pd		1	22.2	20d	
21	6	24.6	1Pd		21	5.1	10d	11	4.6	1Pd	4	53.7	20d		1	44.9	3Pd	
	6	43.3	10d		22	49.1	1Pf	11	26.9	10d	6	9.9	2Pf		2	36.0	2Pf	
	7	23.2	2Im	28	22	59.7	10f	13	10.1	1Pf	6	19.9	20f		2	46.6	20f	
	8	28.2	1Pf		3	47.7	2Im	13	21.9	10f	11	8.5	3Im		2	49.3	1Im	
	8	37.5	10f		6	.3	3Im	20	34.5	3Pd	12	29.7	1Im		3	19.6	3Pf	
	15	28.2	3Pd		7	36.2	3Em	22	10.5	3Pf	12	45.1	3Em		5	12.9	1Ef*	
	17	1.9	3Pf		7	51.9	1Im	22	10.5	1Im	14	52.2	1Ef*		14	23.0	1Pd	
	17	33.8	1Im		10	10.9	1Ef*	0	12.9	2Im	20	38.8	2Im		14	48.0	10d	
	19	50.4	1Ef*		19	21.6	1Pd	0	31.5	1Ef*	12	0	2.2	1Pd		16	30.0	1Pf
	23	46.9	2Pd		19	42.5	10d	9	41.8	1Pd	0	26.1	10d		16	43.6	10f	
22	0	22.3	20d		20	11.4	2Pd	10	4.3	10d	2	8.6	1Pf		17	5.3	2Im	
	1	46.3	2Pf		20	50.6	20d	11	47.4	1Pf	2	21.5	10f	19	0	23.6	3Im	
	1	53.6	20f		21	26.3	1Pf	11	59.4	10f	9	48.5	3Pd		1	26.5	1Im	
	5	1.7	1Pd		21	37.2	10f	16	36.5	2Pd	11	6.7	1Im		1	58.9	3Em	
	5	20.7	10d		22	11.7	2Pf	17	18.9	20d	11	24.2	3Pf		3	50.2	1Ef*	
	7	5.4	1Pf		22	20.1	20f	18	37.2	2Pf	13	2.2	2Pd		9	28.7	2Pd	
	7	15.0	10f	29	4	39.9	3Pd	18	46.7	20f	13	29.5	1Ef*		10	15.9	20d	
	14	6.6	3Im		6	15.3	3Pf	19	13.0	3Im	13	47.4	20d		11	29.2	2Pf	
	15	41.1	3Em		6	28.8	1Im	20	47.5	1Im	15	3.1	2Pf		11	39.9	20f	
	16	10.6	1Im		8	48.2	1Ef*	20	49.8	3Em	15	13.3	20f		13	.3	1Pd	
	16	16.0	2Im		12	40.7	2Im	23	8.8	1Ef*	22	39.5	1Pd		13	25.4	10d	
	18	27.6	1Ef*		17	58.7	1Pd	8	18.9	1Pd	23	3.5	10d		15	7.3	1Pf	
23	3	38.8	1Pd		18	19.9	10d	8	41.7	10d	13	0	46.0	1Pf		15	21.0	10f
	3	58.1	10d		20	3.6	1Pf	9	6.0	2Im	0	59.0	10f		23	3.9	3Pd	
	5	42.7	1Pf		20	14.6	10f	10	24.7	1Pf	5	32.0	2Im	20	0	3.6	1Im	
	5	52.4	10f		3	18.4	3Im	10	36.8	10f	8	27.2	3Im		0	38.1	3Pf	
	8	39.8	2Pd	30	4	54.6	3Em	17	52.9	3Pd	9	43.8	1Im		1	58.7	2Im	
	9	15.9	20d		5	4.3	2Pd	19	24.5	1Im	10	3.5	3Em		2	27.4	1Ef*	
	10	39.4	2Pf		5	5.8	1Im	19	28.9	3Pf	12	6.7	1Ef*		11	37.6	1Pd	
	10	46.9	20f		5	44.2	20d	21	46.0	1Ef*	21	16.7	1Pd		12	2.8	10d	
	12	46.0	3Pd		7	4.7	2Pf	1	29.6	2Pd	21	40.9	10d		13	44.7	1Pf	
	14	20.2	3Pf		7	13.4	20f	2	12.6	20d	21	55.5	2Pd		13	58.5	10f	
	14	47.5	1Im		7	25.4	1Ef*	3	30.4	2Pf	22	41.1	20d		18	22.0	2Pd	
	17	4.8	1Ef*		16	35.9	1Pd	3	40.0	20f	23	23.3	1Pf		19	9.6	20d	
24	1	8.9	2Im		16	57.3	10d	6	56.1	1Pd	23	36.4	10f		20	22.5	2Pf	
	2	15.9	1Pd		18	40.9	1Pf	7	19.1	10d	23	56.3	2Pf		20	33.2	20f	
	2	35.5	10d		18	52.1	10f	9	2.0	1Pf	14	0	6.6	20f		21	42.6	3Im
	4	19.9	1Pf		21	33.7	2Im	9	14.3	10f	7	7.2	3Pd		22	40.8	1Im	
	4	29.9	10f					16	31.4	3Im	8	20.9	1Im		23	17.4	3Em	
	11	24.4	3Im	Déc.	h	m		17	59.2	2Im	8	42.7	3Pf	21	1	4.7	1Ef*	
	12	59.5	3Em	1	1	58.0	3Pd	18	1.5	1Im	10	43.9	1Ef*		10	14.9	1Pd	
	13	24.4	1Im		3	33.7	3Pf	18	8.2	3Em	14	25.3	2Im		10	40.2	10d	
	15	42.0	1Ef*		3	42.7	1Im	20	23.3	1Ef*	19	54.0	1Pd		10	52.1	2Im	
	17	32.6	2Pd		6	2.6	1Ef*	5	33.3	1Pd	20	18.3	10d		12	22.0	1Pf	
	18	9.6	20d		13	57.3	2Pd	5	56.5	10d	22	.6	1Pf		12	35.9	10f	
	19	32.4	2Pf		14	37.9	20d	7	39.3	1Pf	22	13.9	10f		20	23.0	3Pd	

## 1997- PHÉNOMÈNES DES SATELLITES DE SATURNE

21	17.9	1Im		19	15.0	3Pf		5	28.8	1Pf		2	57.8	10f		9	25.7	20d	
21	56.5	3Pf		20	56.4	1Ef*		5	43.0	10f		7	19.5	2Im		9	49.8	3Em	
22	23	41.9	1Ef*	24	4	39.0	2Im	5	55.8	2Pd		10	59.6	3Im		10	35.6	2Pf	
	3	15.4	2Pd		6	6.8	1Pd	6	44.5	20d		11	38.4	1Im		10	46.5	20f	
	4	3.3	20d		6	32.4	10d	7	55.6	2Pf		12	31.3	3Em		11	17.2	1Ef*	
	5	15.8	2Pf		8	14.1	1Pf	8	6.5	20f		14	2.7	1Ef*		20	28.1	1Pd	
	5	26.5	20f		8	28.2	10f	13	40.2	3Im		23	13.4	1Pd		20	54.2	10d	
	8	52.2	1Pd		16	20.9	3Im	14	23.9	1Im		23	39.4	10d		22	35.6	1Pf	
	9	17.6	10d		17	9.5	1Im	15	12.8	3Em		23	42.8	2Pd		22	50.1	10f	
	10	59.4	1Pf		17	54.3	3Em	16	48.2	1Ef*	29	0	32.0	20d	31	1	6.7	2Im	
	11	13.3	10f		19	33.7	1Ef*	22	26.0	2Im		1	20.9	1Pf		6	59.6	3Pd	
	19	1.7	3Im		21	2.3	2Pd	27	1	58.7	1Pd		1	35.2	10f		7	30.2	1Im
	19	45.5	2Im		21	50.8	20d		2	24.6	10d		1	42.3	2Pf		8	28.9	3Pf
	19	55.1	1Im		23	2.3	2Pf		4	6.2	1Pf		1	53.2	20f		9	54.5	1Ef*
	20	35.9	3Em		23	13.2	20f		4	20.4	10f		9	40.1	3Pd		17	29.9	2Pd
23	22	19.2	1Ef*	25	4	44.1	1Pd	12	20.7	3Pd		10	15.7	1Im		18	19.4	20d	
	7	29.5	1Pd		5	9.8	10d	13	1.2	1Im		11	10.5	3Pf		19	5.4	1Pd	
	7	55.0	10d		6	51.4	1Pf	13	52.0	3Pf		12	40.0	1Ef*		19	28.9	2Pf	
	9	36.7	1Pf		7	5.6	10f	14	49.3	2Pd		16	13.1	2Im		19	31.6	10d	
	9	50.8	10f		13	32.5	2Im	15	25.5	1Ef*		21	50.7	1Pd		19	39.8	20f	
	12	8.9	2Pd		15	1.3	3Pd	15	38.2	20d		22	16.8	10d		21	13.0	1Pf	
	12	57.1	20d		15	46.7	1Im	16	49.0	2Pf		23	58.3	1Pf		21	27.5	10f	
	14	9.1	2Pf		16	33.5	3Pf	16	59.8	20f	30	0	12.6	10f					
	14	19.9	20f		18	11.0	1Ef*	28	0	36.1	1Pd		8	19.0	3Im				
	17	42.1	3Pd	26	3	21.4	1Pd		1	2.0	10d		8	36.3	2Pd				
	18	32.3	1Im		3	47.2	10d		2	43.5	1Pf		8	52.9	1Im				