



HAL
open science

Satellites galiléens de Jupiter : phénomènes et configurations pour 1996, suivis d'une méthode permettant de calculer les phénomènes pour 1997

Th. Derouazi, D.T. Vu, Ch. Ruatti

► To cite this version:

Th. Derouazi, D.T. Vu, Ch. Ruatti. Satellites galiléens de Jupiter : phénomènes et configurations pour 1996, suivis d'une méthode permettant de calculer les phénomènes pour 1997. [Rapport de recherche] Institut de mécanique céleste et de calcul des éphémérides (IMCCE). 1995, 73 p., figures, tableaux. hal-01464907

HAL Id: hal-01464907

<https://hal-lara.archives-ouvertes.fr/hal-01464907>

Submitted on 10 Feb 2017

HAL is a multi-disciplinary open access archive for the deposit and dissemination of scientific research documents, whether they are published or not. The documents may come from teaching and research institutions in France or abroad, or from public or private research centers.

L'archive ouverte pluridisciplinaire **HAL**, est destinée au dépôt et à la diffusion de documents scientifiques de niveau recherche, publiés ou non, émanant des établissements d'enseignement et de recherche français ou étrangers, des laboratoires publics ou privés.

SATELLITES GALILÉENS DE JUPITER

PHÉNOMÈNES ET CONFIGURATIONS POUR 1996

SUIVIS D'UNE MÉTHODE PERMETTANT DE CALCULER LES

PHÉNOMÈNES POUR 1996/7

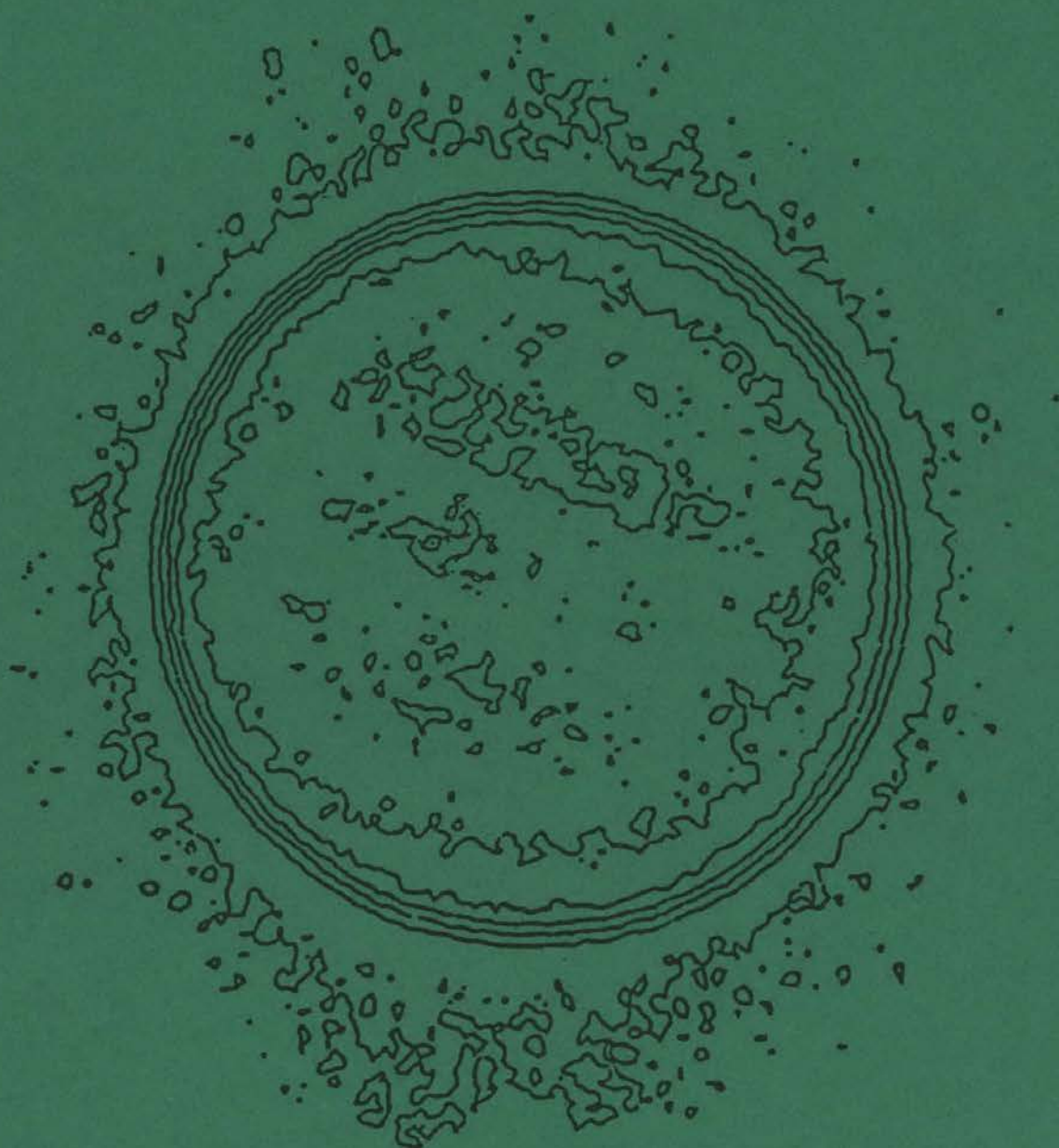

Supplément à la CONNAISSANCE DES TEMPS

à l'usage des observateurs

Bureau des longitudes, URA n° 707 du CNRS

Paris, décembre 1995

SATELLITES GALILÉENS DE JUPITER

GALILEAN SATELLITES OF JUPITER

PHÉNOMÈNES ET CONFIGURATIONS POUR 1996, SUIVIS D'UNE
MÉTHODE PERMETTANT DE CALCULER LES PHÉNOMÈNES POUR 1997

PHENOMENA AND CONFIGURATIONS FOR 1996, FOLLOWED BY A
METHOD FOR THE CALCULATION OF THE PHENOMENA FOR 1997

Supplément à la CONNAISSANCE DES TEMPS
à l'usage des observateurs

Bureau des longitudes, URA n° 707 du CNRS

Paris, décembre 1995

**LE SERVICE MINITEL
DU BUREAU DES LONGITUDES
3616 code BDL**

Le *Service Minitel* du Bureau des Longitudes met à la disposition des professionnels et des amateurs les informations suivantes:

- les actualités astronomiques;
- les heures du lever et du coucher du Soleil et de la Lune, les azimuts et hauteurs du Soleil en n'importe quel lieu, de -4000 à 2500;
- les phases de la Lune et les dates des saisons de -4000 à 2500;
- les éclipses du Soleil et de la Lune pour six années;
- les positions apparentes géocentriques, les hauteurs et azimuts, les heures du lever et du coucher du Soleil, de la Lune et des planètes de 1900 à 2020;
- les coordonnées héliocentriques moyennes des planètes de 1900 à 2020 dans le repère de la date;
- les positions des satellites naturels, les phénomènes des satellites galiléens pour quatre ans, et les phénomènes des satellites de Saturne pour la période actuelle;
- les définitions et les concordances des calendriers, les fêtes légales et religieuses, l'heure légale en France, les dates de changement d'heure et le calcul du jour de la semaine.

Il fournit également des informations ponctuelles comme les passages des comètes et des astéroïdes, les pluies d'étoiles filantes...

Imprimé au Bureau des Longitudes

ISSN 0769 - 1033

Dépôt légal : décembre 1995

LES SERVEURS
DU BUREAU DES LONGITUDES SUR INTERNET

<http://www.bdl.fr> et <ftp://ftp.bdl.fr>

Le Bureau des longitude diffuse de nombreuses informations, périodiquement remises à jour, grace à ses serveurs sur le réseau *Internet*. Outre des informations générales sur l'historique et les activités du Bureau des longitudes, on peut y trouver des données scientifiques concernant les objets du système solaire:

- éphémérides de planètes et de satellites, phénomènes;
- éléments orbitaux de comètes;
- données sur les éclipses de Soleil;
- images astronomiques.

Un serveur WEB est accessible à l'adresse <http://www.bdl.fr>. Un serveur ftp anonyme est accessible à l'adresse: <ftp://ftp.bdl.fr>.

THE INTERNET SERVERS
OF BUREAU DES LONGITUDES
<http://www.bdl.fr> and <ftp://ftp.bdl.fr>

Bureau des longitude publishes informations thanks to *Internet* servers. Besides general information concerning history and activities of Bureau des longitudes, one may access scientific data on:

- ephemerides of planets and satellites, phenomena;
- orbital elements of comets;
- data on Solar eclipses;
- astronomical images.

The address of the WEB Server is: <http://www.bdl.fr>. One can also access an anonymous-ftp server at the address: <ftp://ftp.bdl.fr>.

TABLE DES MATIERES	Page	TABLE OF CONTENTS	Page
Avertissement	7	<i>Foreword</i>	<i>7</i>
Données sur les satellites galiléens	9	<i>Data on the Galilean satellites</i>	<i>9</i>
Théories du mouvement des satellites galiléens	10	<i>Theory of the motion of the Galilean Satellites</i>	<i>10</i>
Présentation des éphémérides	11	<i>Presentation of the ephemerides</i>	<i>11</i>
Phénomènes et configurations pour 1996	17	<i>Phenomena and configurations for 1996</i>	<i>17</i>
Phénomènes pour 1997	67	<i>Phenomena for 1997</i>	<i>67</i>

PUBLICATIONS DU BUREAU DES LONGITUDES

Publications éditées par Les Éditions de Physique, Les Ulis

Connaissance des Temps 1996.

Publications éditées par Dunod-Bordas, Paris

Éphémérides Nautiques 1996.

Encyclopédie scientifique de l'Univers.

La physique (1981).

La Terre, les eaux, l'atmosphère (réédition, 1984).

Les étoiles, le système solaire (réédition, 1986).

La galaxie, l'univers extragalactique (réédition, 1988).

Publications éditées par Masson, Paris

Annuaire du Bureau des Longitudes. Éphémérides astronomiques 1996.

Cahiers des Sciences de l'Univers, publiés sous l'égide du Bureau des longitudes.

1. Les profondeurs de la Terre par J.P. Poirier.
2. Stratosphère et couche d'ozone par G. Mégie.
3. Chronique de l'espace temps - Du vide quantique à l'expansion cosmique par A. Mazure, G. Mathez, Y. Mellier.

Publications éditées par le Bureau des longitudes

Supplément à la Connaissance des Temps

Éphémérides des satellites faibles de Jupiter (VI, VII, VIII, IX) et de Saturne (IX) pour 1996.

Phénomènes et configurations des satellites galiléens de Jupiter pour 1996.

Configurations des huit premiers satellites de Saturne pour 1996.

Le Calendrier Républicain (réédition, 1995).

Notes scientifiques et techniques du Bureau des longitudes.

AVERTISSEMENT

Depuis 1985, un supplément à la *Connaissance des Temps* est publié et donne les positions des satellites de Mars, des satellites galiléens de Jupiter, des huit premiers satellites de Saturne et des cinq satellites d'Uranus sous forme de fonctions mixtes avec une précision proche des théories originales. Une disquette pour micro-ordinateur accompagne cet ouvrage.

A partir de 1996, ces éphémérides des satellites naturels sont publiés dans la *Connaissance des Temps*.

Cependant, des observateurs ont souhaité continuer à disposer d'un ouvrage permettant d'identifier les satellites galiléens et de connaître les instants des phénomènes présentés par ces satellites et calculés à une seconde de temps près. C'est ce que donne le présent fascicule. En particulier, les configurations précises permettent très facilement de situer les satellites avec une précision de 10" par rapport à Jupiter.

On trouvera de plus des renseignements généraux sur les satellites galiléens en début d'ouvrage ainsi qu'une méthode de calcul des phénomènes pour l'année suivante en fin d'ouvrage.

FOREWORD

*Since 1985, a supplement to the *Connaissance des Temps* is published and gives the positions of the Satellites of Mars, of the Galilean Satellites of Jupiter, of the First Eight Satellites of Saturn and of the Five Satellites of Uranus under a mixed form of representation, involving secular and periodic terms and depending directly on time. The accuracy is near that of the original theories. A floppy disk is available with these ephemerides.*

*Starting from 1996, these ephemerides of natural Satellites are published in the *Connaissance des Temps*.*

However, observers wish to keep ephemerides allowing to identify immediately the Galilean Satellites and to know the dates of the phenomena which are calculated to the nearest second of time. This is given by the present booklet, particularly the configurations giving positions with an accuracy of 10" relatively to Jupiter.

Besides these informations, the present booklet gives various data concerning the Galilean Satellites. We also present a method which permits the calculation of the phenomena for the next year.

J.-E. ARLOT

W. THUILLOT

Responsables de la publication

Phénomènes et Configurations des satellites galiléens de Jupiter
Supplément à la *Connaissance des Temps* à l'usage des observateurs.

Rédaction et calculs : Th. DEROUAZI, D.T. VU, Ch. RUATTI.

DATA ON THE GALILEAN SATELLITES

	IO (I)	EUROPE (II)	GANYMEDE (III)	CALLISTO (IV)
<i>Masses</i> (10^{-5} masse de Jupiter)				
Sampson (1921) :	4.50	2.54	7.99	4.50
De Sitter (1931) :	3.81	2.48	8.17	5.09
Pioneer 11 (1976) :	4.68	2.52	7.80	5.66
<i>Rayons</i> (km)				
Danjon (1954) :	1650	1400	2450	2300
Dollfus (1961) :	1775	1550	2800	2525
Pioneer 11 (1976) :	1840	1552	2650	2420
Voyager (1983) :	1816	1563	2638	2410
<i>Magnitudes visuelles</i> à l'opposition de Jupiter				
Harris (1961) :	4.8	5.2	4.5	5.5
<i>Albédos géométriques</i> (Harris, 1961)				
U : 353 nm	0.19	0.47	0.29	0.14
B : 448 nm	0.56	0.67	0.41	0.21
V : 554 nm	0.92	0.83	0.49	0.26
R : 690 nm	1.12	0.93	0.56	0.30
I : 820 nm	1.15	0.95	0.57	0.31
<i>Albédo de Bond</i> (visuel)				
	0.54	0.49	0.29	0.15
<i>Demi-grand axe</i> (Sampson, 1921)				
en UA :	0.002820	0.004486	0.007155	0.012586
en rayons de Jupiter :	5.87	9.34	14.91	26.22
en kilomètres :	421810	671140	1070500	1882900
<i>Plus grande élongation</i> à l'opposition de Jupiter (minutes et secondes de degré)				
Sampson (1921) :	2'17"	3'40"	5'48"	10'13"
<i>Période synodiques</i> (jours)				
Sampson (1921) :	1.7698604883	3.5540941742	7.1663872292	16.7535523007
<i>Inclinaison moyenne sur</i> l'équateur de Jupiter pour 1996.5 (minutes et secondes de degré)				
Sampson (1921) :	1'12"	27'36"	9'00"	22'41"
<i>Valeur moyenne de l'excentricité</i> pour 1996.5				
Sampson (1921) :	0.004	0.009	0.002	0.007
<i>Partie séculaire du mouvement</i> (degré par an)				
noeud :	- 48.5	- 11.9	- 2.6	- 0.6
périjove :	57.0	14.6	2.7	0.7
Sampson (1921)				

**THEORIE DU MOUVEMENT
DES SATELLITES GALILEENS**

**THEORY OF THE MOTION OF
THE GALILEAN SATELLITES**

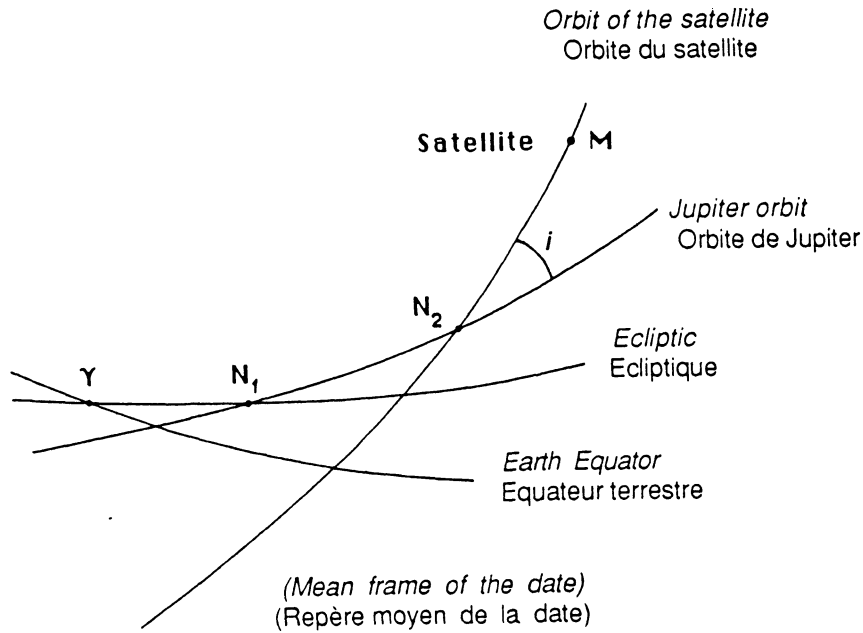

Du fait de la complexité du mouvement des satellites galiléens, il est difficile de donner des valeurs précises pour les noeuds et les périjoves. En effet, les excentricités et les inclinaisons sont faibles (cf. tableau précédent) et tous ces éléments sont soumis à de grandes variations (Thuillot, Vu, 1985).

Because of the complexity of the motion of the Galilean Satellites of Jupiter it is difficult to provide precise values for nodes and perijoves. Indeed, eccentricities and inclinations are small (see the preceding table) and all these elements undergo large variations (Thuillot, Vu, 1985).

On donne ci-après les longitudes moyennes (d'après Sampson, 1921) dans le plan des orbites, ce plan étant confondu avec l'équateur de Jupiter.

The mean longitudes (Sampson, 1921) in the orbital planes identified with Jupiter's equator are given below.

Si τ est le temps en jours moyens compté à partir de 1900,0 on a :

If τ is the time in days which has elapsed from 1900.0, one gets :

$\gamma N_1 N_2 = 316^\circ.051 + 0.00003559 \tau, \quad i = 3^\circ.10350$		
$\gamma N_1 + N_1 N_2 + N_2 M =$		Période sidérale en jours <i>Sidereal period in days</i>
Io	$42^\circ.59987 + 203.488992435 \tau$	1.7691374639
Europe	$99^\circ.55081 + 101.374761672 \tau$	3.5511797420
Ganymede	$168^\circ.02628 + 50.317646290 \tau$	7.1545476894
Callisto	$234^\circ.40790 + 21.571109630 \tau$	16.6889884746

PRESENTATION DES EPHEMERIDES
PRESENTATION OF THE EPHEMERIDES

ECHELLES DE TEMPS

L'argument "temps" des éphémérides publiées ici est le TT (temps terrestre) proche du TE (temps des éphémérides) et réalisé physiquement par la mesure du TAI (temps atomique international). On a :

$$TT = TAI + 32,184 \text{ s}$$

Les événements astronomiques étant mesurés dans l'échelle UTC (temps universel coordonné), le tableau ci-dessous donne la relation entre TT et UTC (d'après la relation entre TAI et UTC publiée par l'IERS).

TT-UTC

du 1 janvier 1991 au	
1 juillet 1992	58,184 s
du 1 juillet 1992 au	
1 juillet 1993	59,184 s
du 1 juillet 1993 au	
1 juillet 1994	60,184 s
du 1 juillet 1994 au	
1 janvier 1996	61,184 s

TIME-SCALES

The time argument of the ephemerides is TT (terrestrial time) close to the former definition of ET (ephemeris time) and physically made by measuring TAI (international atomic time), so that :

$$TT = TAI + 32.184 \text{ s}$$

Astronomical events are measured in the time-scale UTC (coordinate universal time). The table below gives the correspondence between TTT and UTC (using the relationship between TAI and UTC published by IERS).

TTT-UTC

<i>From January 1, 1991</i>	
<i>to July 1, 1992</i>	<i>58.184 s</i>
<i>From July 1, 1992</i>	
<i>to July 1, 1993</i>	<i>59.184 s</i>
<i>From July 1, 1993</i>	
<i>to July 1, 1994</i>	<i>60.184 s</i>
<i>From July 1, 1994</i>	
<i>to January 1996</i>	<i>61.184 s</i>

PHENOMENES DES SATELLITES GALILEENS

Les hypothèses utilisées pour le calcul des époques des phénomènes (Thuillot, 1989) sont les suivantes :

- Jupiter est un ellipsoïde dont l'aplatissement a pour valeur 1/15 et dont le rayon équatorial est 71420 km.

- Les satellites sont des sphères de rayon : 1840 km pour Io, 1552 km pour Europe, 2650 km pour Ganymède, 2420 km pour Callisto (d'après Pioneer 11).

- Le Soleil est une sphère de rayon 695980 km.

- Les dates sont données pour tout observatoire terrestre puisqu'on peut négliger l'effet de parallaxe dont la grandeur est plus faible que la précision des prédictions.

PHENOMENA OF THE GALILEAN SATELLITES

The hypothesis made for the calculations of the dates of the phenomena (Thuillot, 1989) are :

- Jupiter is an ellipsoid the flatness of which is 1/15 and the equatorial radius of which is 71420 km.

- The satellites are spheres the radius of which are : 1840 km for Io, 1552 km for Europe, 2650 km for Ganymede and 2420 km for Callisto (from Pioneer 11).

- The Sun is a sphere the radius of which is 695980 km.

- The dates are given for everywhere on Earth since no parallax effect has to be taken into account.

12. L'effet de phase est négligé pour les satellites, mais pris en compte pour la planète.

Les pages paires fournissent les dates des phénomènes que présentent ces satellites :

. les débuts et fins des passages des satellites devant la planète :

PA.D.INT et PA.D.EXT
PA.F.INT et PA.F.EXT

. les débuts et fins de leurs occultations (anciennement appelées immersions et émergences) :

OC.D.INT et OC.D.EXT
OC.F.INT et OC.F.EXT

. les débuts et fins des passages de leur ombre sur Jupiter :

OM.D.INT et OM.D.EXT
OM.F.INT et OM.F.EXT

. les débuts et fins des éclipses des satellites par Jupiter :

EC.D.INT, EC.D.EXT, EC.D.PEN
EC.F.INT, EC.F.EXT, EC.F.PEN

Les notations utilisées sont les suivantes :

. D et .F désignent le début et la fin.

. INT désigne les contacts intérieurs des satellites avec le cône d'ombre pour les éclipses et les passages des ombres sur Jupiter, et désigne les mêmes contacts avec le cône de visibilité pour les occultations et les passages devant la planète.

. EXT désigne les contacts extérieurs des satellites avec le cône d'ombre pour les éclipses et les passages des ombres sur Jupiter, et désigne les mêmes contacts avec le cône de visibilité pour les occultations et les passages devant la planète.

.-PEN désigne uniquement pour les éclipses, le contact extérieur des satellites avec le cône de pénombre.

The phase defect is neglected on the satellites but taken into account for Jupiter.

Even pages give the dates of the phenomena :

. the beginnings and the ends of the transits of the satellites in front of Jupiter :

*PA.D.INT and PA.D.EXT
PA.F.INT and PA.F.EXT*

. the beginnings and the ends of the occultations of the satellites by Jupiter :

*OC.D.INT and OC.D.EXT
OC.F.INT and OC.F.EXT*

. the beginnings and the ends of the transits of the umbra of the satellites on the disk of Jupiter :

*OM.D.INT and OM.D.EXT
OM.F.INT and OM.F.EXT*

. the beginnings and the ends of the eclipses of the satellites by Jupiter :

*EC.D.INT, EC.D.EXT, EC.D.PEN
EC.F.INT, EC.F.EXT, EC.F.PEN*

The notations means :

. D and .F mean beginning and end.

. INT means :

- interior contact satellite/shadow cone for the eclipses and transits of shadows on Jupiter.

- interior contact satellite/cone of visibility for the occultations and the transits.

. EXT means :

- exterior contact satellite/shadow cone for the eclipses and transits of shadows on Jupiter.

- exterior contact satellite/cone of visibility for the occultations and the transits.

. PEN means :

- exterior contact satellite/penumbra cone for the eclipses.

EXEMPLE

Le déroulement d'un début d'éclipse se fait ainsi :

EC.D.PEN : contact extérieur du satellite avec le cône de pénombre (début de l'assombrissement).

EC.D. EXT : contact extérieur avec le cône d'ombre.

EC.D.INT : contact extérieur avec le cône d'ombre (assombrissement total).

On observera que les éclipses se produisent à l'ouest ou à l'est de la planète, suivant que l'on est avant ou après l'opposition. En général pour le premier et le deuxième satellite, on ne peut, avant l'opposition, observer que le début des éclipses suivi de la fin des occultations. Après l'opposition on ne peut observer que le début des occultations suivi de la fin des éclipses. Il est possible, d'autre part, que, en raison de l'inclinaison de l'équateur de Jupiter sur l'écliptique et de l'éloignement du satellite IV Callisto par rapport à la planète, aucun phénomène de ce satellite ne se produise.

EXAMPLE

A beginning of an exlipse occurs as follows :

***EC.D.PEN** : external contact of the satellite with the cone of penumbra (beginning of the penumbra) .*

***EC.D.EXT** : external contact with the shadow cone.*

***EC.D.INT** : internal contact with the shadow cone (the satellite has disappeared in the umbra).*

Note that the eclipses occur west of the planet before the opposition. Most of time for the first and the second satellite, only the beginning of the eclipse followed by the end of the occultation are observable. On the other hand, it may happened that no phenomenon occurs for satellite IV because it is far from Jupiter and because of the inclination of the equator of Jupiter above the ecliptic.

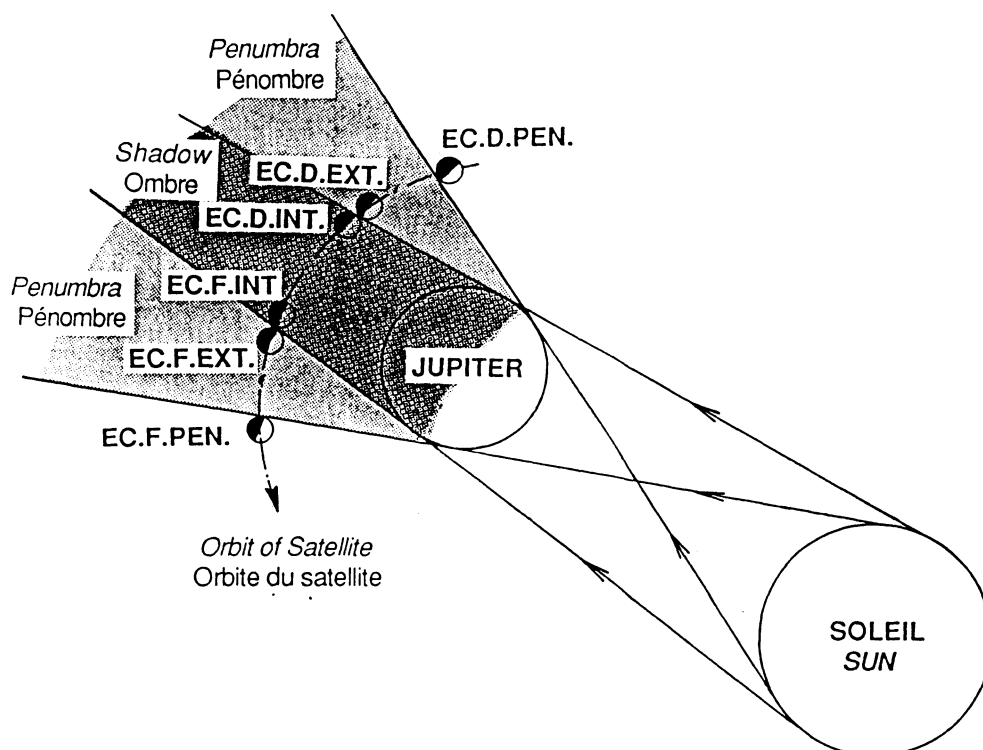

Les configurations permettent d'identifier les satellites, et également de déterminer leur position en coordonnées tangentiels équatoriales relatives à Jupiter avec la précision suivante (pour une lecture des courbes à 0,5 mm près) :

- . Satellite 1 : de 5" à 20" selon la vitesse apparente
- . Satellite 2 : de 5" à 10" selon la vitesse apparente
- . Satellites 3 et 4 : 5"

L'exemple suivant montre comment déterminer les positions des satellites :

The configurations permit to identify the satellites and to approach their positions relative to Jupiter in an equatorial tangential frame with the following precision (corresponding to a measure on the curves with an accuracy of 0,5 millimeter).

- . Satellite 1 : from 5" to 20" depending on the apparent velocity
- . Satellite 2 : from 5" to 10" depending on the apparent velocity
- . Satellites 3 and 4 : 5"

The following example shows how to determine the positions of the satellites :

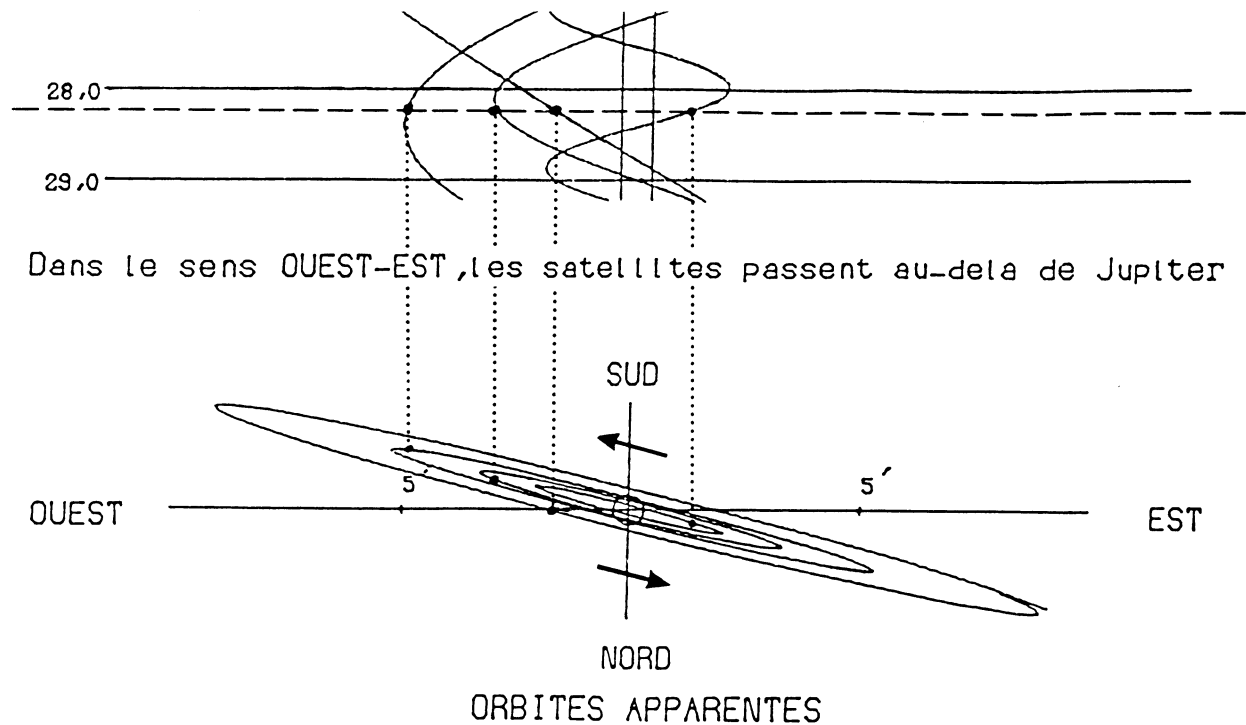

On reporte en abscisse sur l'axe ouest-est les distances $\Delta\alpha \cos \delta$ mesurées pour une date voulue, sur les courbes. L'ordonnée est donnée par les orbites apparentes. L'indétermination avant/arrière est levée grâce au sens de rotation des satellites.

For the abscissae, we have to project the differential coordinate $\Delta\alpha \cos \delta$ measured on the curves for a determined date on the East-West axis. For the ordinates, we have to project these abscissae on the apparent orbits as indicated on the figure. The front/back indetermination is removed thanks to the direction of the rotation of the satellites.

Les prédictions des phénomènes des satellites galiléens sont données suivant une représentation polynomiale en fonction d'une variable temporelle. La méthode (Thuillot, 1983) permet une représentation compacte puisque 12 coefficients suffisent à représenter chaque type de phénomène (passages, occultations, éclipses, passages d'ombre, débuts ou fins) de chaque satellite pour une année entière avec une précision de l'ordre de la minute de temps.

The predictions of the phenomena of the Galilean Satellites are given as a polynomial representation which depends directly on time. The method (Thuillot, 1983) allows a compact representation as only 12 coefficients are sufficient to represent each type of phenomenon (transits, occultations, eclipses, shadow transits, beginnings or ends) for each satellite for a complete year with an accuracy of about one minute of time.

Des explications sur cette méthode, le formulaire et les tables de coefficients sont donnés pages 69 à 73.

Some explanations about the method, the formulae and the tables of coefficients are given on pages 69 to 73.

REFERENCES

- Arlot, J.E. : 1982, *Astron. Astrophys.* **107**, 305.
Lieske, J.H. : 1977, *Astron. Astrophys.* **56**, 333.
Sampson, R.A. : 1921, *Mem. Roy. Astron. Soc.* **63**.
Thuillot, W. : 1983, *Astron. Astrophys.* **127**, 63.
Thuillot, W., Vu, D.T. : 1985, Note Scientifique et Technique du Bureau des Longitudes S009.
Thuillot, W. : 1989, Note Scientifique et technique du Bureau des Longitudes S015.

ÉPHÉMÉRIDES

PHÉNOMÈNES ET CONFIGURATIONS

POUR 1996

1996 - PHÉNOMÈNES DES SATELLITES GALILÉENS DE JUPITER
(Temps Terrestre)

PREMIÈRE QUINZAINE DE JANVIER																	
jour	h	m	s	SAT.	TYPE	jour	h	m	s	SAT.	TYPE	jour	h	m	s	SAT.	TYPE
0	1	20	37	II	OC.F.INT	7	10	30	II	PA.D.INT							
	1	24	40	II	OC.F.EXT	9	13	35	II	OM.F.INT	11	1	29	37	III	EC.D.PEN	
	7	27	57	III	OM.D.EXT	9	17	43	II	OM.F.EXT	1	33	28	III	EC.D.EXT		
	7	39	8	III	OM.D.INT	9	50	9	II	PA.F.INT	1	44	47	III	EC.D.INT		
	8	20	43	III	PA.D.EXT	9	54	16	II	PA.F.EXT	5	55	13	III	OC.F.INT		
	8	31	51	III	PA.D.INT	22	44	58	I	EC.D.PEN	6	6	8	III	OC.F.EXT		
	10	14	13	III	OM.F.INT	22	45	43	I	EC.D.EXT	6	10	36	I	EC.D.PEN		
	10	25	26	III	OM.F.EXT	22	49	28	I	EC.D.INT	6	11	21	I	EC.D.EXT		
	11	6	54	III	PA.F.INT						6	15	5	I	EC.D.INT		
	11	18	2	III	PA.F.EXT	6	1	18	I	OC.F.INT	8	49	14	I	OC.F.INT		
	15	19	13	I	EC.D.PEN	1	21	54	I	OC.F.EXT	8	52	58	I	OC.F.EXT		
	15	19	58	I	EC.D.EXT	19	55	4	I	OM.D.EXT							
	15	23	43	I	EC.D.INT	19	58	47	I	OM.D.INT	12	3	20	25	I	OM.D.EXT	
	17	46	53	I	OC.F.INT	20	14	40	I	PA.D.EXT	3	24	8	I	OM.D.INT		
	17	50	37	I	OC.F.EXT	20	18	23	I	PA.D.INT	3	45	17	I	PA.D.EXT		
						22	8	38	I	OM.F.INT	3	49	0	I	PA.D.INT		
1	12	29	43	I	OM.D.EXT	22	12	22	I	OM.F.EXT	5	34	1	I	OM.F.INT		
	12	33	26	I	OM.D.INT	22	27	56	I	PA.F.INT	5	37	44	I	OM.F.EXT		
	12	43	58	I	PA.D.EXT	22	31	39	I	PA.F.EXT	5	58	38	I	PA.F.INT		
	12	47	41	I	PA.D.INT						6	2	20	I	PA.F.EXT		
	14	43	15	I	OM.F.INT	7	0	47	II	EC.D.PEN	9	5	55	II	OM.D.EXT		
	14	46	58	I	OM.F.EXT	0	49	21	II	EC.D.EXT	9	10	2	II	OM.D.INT		
	14	57	8	I	PA.F.INT	0	53	25	II	EC.D.INT	9	57	9	II	PA.D.EXT		
	15	0	51	I	PA.F.EXT	4	9	38	II	OC.F.INT	10	1	14	II	PA.D.INT		
	17	10	54	II	OM.D.EXT	4	13	40	II	OC.F.EXT	11	50	4	II	OM.F.INT		
	17	15	3	II	OM.D.INT	11	26	56	III	OM.D.EXT	11	54	11	II	OM.F.EXT		
	17	40	24	II	PA.D.EXT	11	38	3	III	OM.D.INT	12	41	12	II	PA.F.INT		
	17	44	32	II	PA.D.INT	12	49	21	III	PA.D.EXT	12	45	17	II	PA.F.EXT		
	19	54	52	II	OM.F.INT	13	0	23	III	PA.D.INT							
	19	59	1	II	OM.F.EXT	14	14	9	III	OM.F.INT	13	0	39	11	I	EC.D.PEN	
	20	24	1	II	PA.F.INT	14	25	18	III	OM.F.EXT	0	39	56	I	EC.D.EXT		
	20	28	8	II	PA.F.EXT	15	36	56	III	PA.F.INT	0	43	40	I	EC.D.INT		
						15	47	57	III	PA.F.EXT	3	19	36	I	OC.F.INT		
2	9	47	51	I	EC.D.PEN	17	13	30	I	EC.D.PEN	3	23	20	I	OC.F.EXT		
	9	48	36	I	EC.D.EXT	17	14	15	I	EC.D.EXT	21	48	50	I	OM.D.EXT		
	9	52	21	I	EC.D.INT	17	18	0	I	EC.D.INT	21	52	33	I	OM.D.INT		
	12	17	22	I	OC.F.INT	19	48	31	I	OC.F.INT	22	15	26	I	PA.D.EXT		
	12	21	6	I	OC.F.EXT	19	52	15	I	OC.F.EXT	22	19	9	I	PA.D.INT		
3	6	58	10	I	OM.D.EXT	8	14	23	31	I	OM.D.EXT	14	0	2	27	I	OM.F.INT
	7	1	53	I	OM.D.INT	14	27	14	I	OM.D.INT	0	6	10	I	OM.F.EXT		
	7	14	12	I	PA.D.EXT	14	44	53	I	PA.D.EXT	0	28	48	I	PA.F.INT		
	7	17	55	I	PA.D.INT	14	48	36	I	PA.D.INT	0	32	31	I	PA.F.EXT		
	9	11	42	I	OM.F.INT	16	37	6	I	OM.F.INT	3	21	54	II	EC.D.PEN		
	9	15	25	I	OM.F.EXT	16	40	49	I	OM.F.EXT	3	23	26	II	EC.D.EXT		
	9	27	24	I	PA.F.INT	16	58	10	I	PA.F.INT	3	27	30	II	EC.D.INT		
	9	31	7	I	PA.F.EXT	17	1	53	I	PA.F.EXT	6	58	27	II	OC.F.INT		
	11	30	48	II	EC.D.PEN	19	47	23	II	OM.D.EXT	7	2	29	II	OC.F.EXT		
	11	32	20	II	EC.D.EXT	19	51	31	II	OM.D.INT	15	25	24	III	OM.D.EXT		
	11	36	24	II	EC.D.INT	20	31	29	II	PA.D.EXT	15	36	27	III	OM.D.INT		
	14	45	9	II	OC.F.INT	20	35	35	II	PA.D.INT	17	16	47	III	PA.D.EXT		
	14	49	12	II	OC.F.EXT	22	31	30	II	OM.F.INT	17	27	43	III	PA.D.INT		
	21	31	29	III	EC.D.PEN	22	35	37	II	OM.F.EXT	18	13	31	III	OM.F.INT		
	21	35	21	III	EC.D.EXT	23	15	25	II	PA.F.INT	18	24	36	III	OM.F.EXT		
	21	46	45	III	EC.D.INT	23	19	31	II	PA.F.EXT	19	7	41	I	EC.D.PEN		
											19	8	26	I	EC.D.EXT		
4	1	26	26	III	OC.F.INT	9	11	42	7	I	EC.D.PEN	19	12	10	I	EC.D.INT	
	1	37	27	III	OC.F.EXT	11	42	51	I	EC.D.EXT	20	5	45	III	PA.F.INT		
	4	16	22	I	EC.D.PEN	11	46	36	I	EC.D.INT	20	16	40	III	PA.F.EXT		
	4	17	7	I	EC.D.EXT	14	18	56	I	OC.F.INT	21	49	53	I	OC.F.INT		
	4	20	52	I	EC.D.INT	14	22	40	I	OC.F.EXT	21	53	36	I	OC.F.EXT		
	6	47	43	I	OC.F.INT												
	6	51	28	I	OC.F.EXT	10	8	51	57	I	OM.D.EXT	15	16	17	16	I	OM.D.EXT
						8	55	40	I	OM.D.INT	16	20	59	I	OM.D.INT		
5	1	26	39	I	OM.D.EXT	9	15	4	I	PA.D.EXT	16	45	36	I	PA.D.EXT		
	1	30	22	I	OM.D.INT	9	18	47	I	PA.D.INT	16	49	19	I	PA.D.INT		
	1	44	28	I	PA.D.EXT	11	5	32	I	OM.F.INT	18	30	54	I	OM.F.INT		
	1	48	11	I	PA.D.INT	11	9	15	I	OM.F.EXT	18	34	37	I	OM.F.EXT		
	3	40	12	I	OM.F.INT	11	28	23	I	PA.F.INT	18	58	59	I	PA.F.INT		
	3	43	55	I	OM.F.EXT	11	32	6	I	PA.F.EXT	19	2	42	I	PA.F.EXT		
	3	57	42	I	PA.F.INT	14	4	51	II	EC.D.PEN	22	23	40	II	OM.D.EXT		
	4	1	25	I	PA.F.EXT	14	6	23	II	EC.D.EXT	22	27	47	II	OM.D.INT		
	6	29	34	II	OM.D.EXT	14	10	27	II	EC.D.INT	23	21	57	II	PA.D.EXT		
	6	33	42	II	OM.D.INT	17	34	5	II	OC.F.INT	23	26	2	II	PA.D.INT		
	7	6	24	II	PA.D.EXT	17	38	7	II	OC.F.EXT							

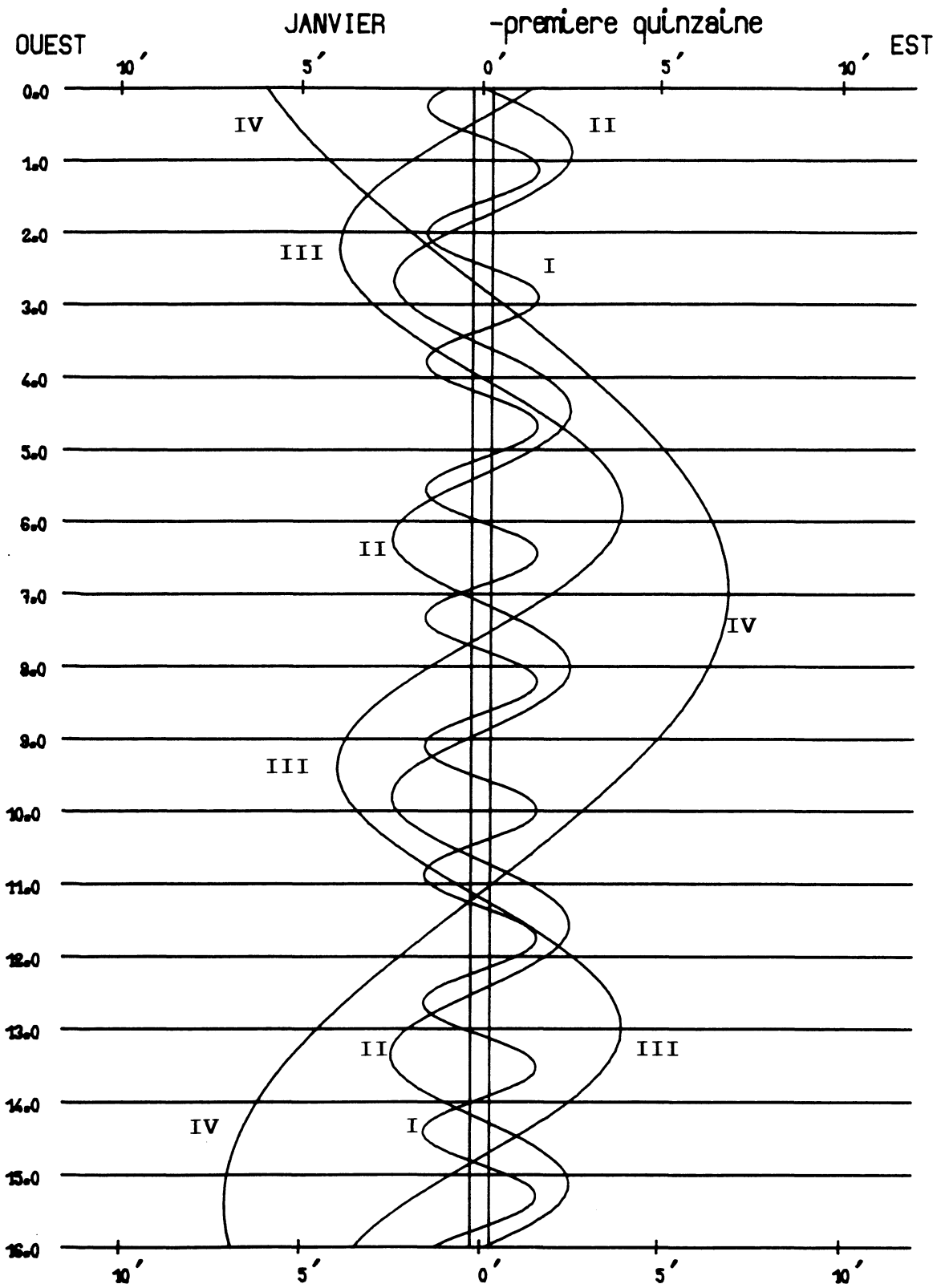

Dans le sens OUEST-EST, les satellites passent au-delà de Jupiter

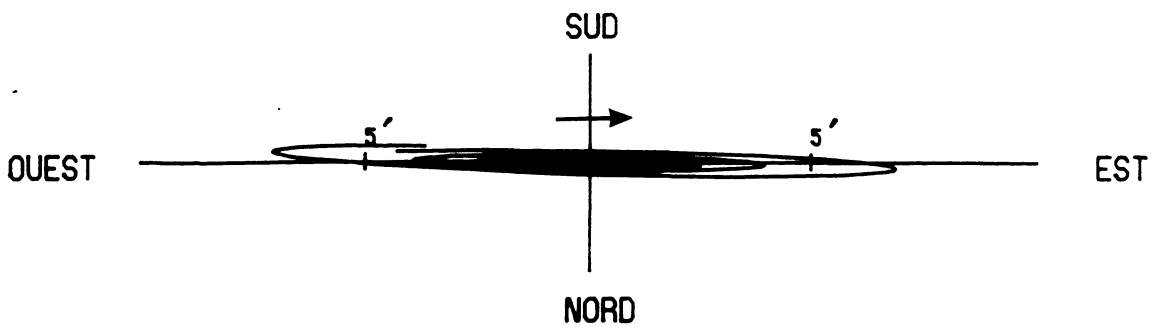

ORBITES APPARENTES

1996 - PHÉNOMÈNES DES SATELLITES GALILÉENS DE JUPITER
(Temps Terrestre)

DEUXIÈME QUINZAINE DE JANVIER																					
jour	h	m	s	SAT.	TYPE	jour	h	m	s	SAT.	TYPE	jour	h	m	s	SAT.	TYPE				
16	1	7	53	II	OM.F.INT	21	1	45	I	EC.D.PEN	17	6	29	II	OM.F.EXT						
	1	12	0	II	OM.F.EXT		21	2	30	I		EC.D.EXT	18	21	7	II	PA.F.INT				
	2	6	10	II	PA.F.INT		21	6	14	I		EC.D.INT	18	25	10	II	PA.F.EXT				
	2	10	15	II	PA.F.EXT		21	43	44	III		PA.D.EXT	27	4	27	16	I	EC.D.PEN			
	13	36	16	I	EC.D.PEN		21	54	33	III		PA.D.INT		4	28	1	I	EC.D.EXT			
	13	37	1	I	EC.D.EXT		22	13	19	III		OM.F.INT		4	31	45	I	EC.D.INT			
	13	40	45	I	EC.D.INT		22	24	19	III		OM.F.EXT		7	21	27	I	OC.F.INT			
	16	20	13	I	OC.F.INT		23	50	54	I		OC.F.INT		7	25	10	I	OC.F.EXT			
	16	23	57	I	OC.F.EXT		23	54	38	I		OC.F.EXT		28	1	36	14	I	OM.D.EXT		
	17	10	45	41	I		OM.D.EXT	22	0	34		3			III	PA.F.INT	1	39	57	I	OM.D.INT
		10	49	24	I		OM.D.INT		0	44		51			III	PA.F.EXT	2	16	11	I	PA.D.EXT
		11	15	43	I		PA.D.EXT		18	10		59			I	OM.D.EXT	2	19	53	I	PA.D.INT
11		19	26	I	PA.D.INT	18	14		42	I	OM.D.INT	3			49	54	I	OM.F.INT			
12		59	19	I	OM.F.INT	18	46		3	I	PA.D.EXT	3			53	37	I	OM.F.EXT			
13		3	2	I	OM.F.EXT	18	49		46	I	PA.D.INT	4			29	42	I	PA.F.INT			
13		29	7	I	PA.F.INT	20	24		38	I	OM.F.INT	4	33		24	I	PA.F.EXT				
13		32	50	I	PA.F.EXT	20	28		21	I	OM.F.EXT	8	30		7	II	EC.D.PEN				
16		38	56	II	EC.D.PEN	20	59		31	I	PA.F.INT	8	31		39	II	EC.D.EXT				
16		40	28	II	EC.D.EXT	21	3		14	I	PA.F.EXT	8	35		42	II	EC.D.INT				
16		44	32	II	EC.D.INT	23	0		59	49	II	OM.D.EXT	12		34	57	II	OC.F.INT			
20		22	45	II	OC.F.INT		1		3	55	II	OM.D.INT	12	38	58	II	OC.F.EXT				
20	26	47	II	OC.F.EXT	2		11	46	II	PA.D.EXT	22	55	43	I	EC.D.PEN						
18	5	27	39	III	EC.D.PEN		2	15	50	II	PA.D.INT	22	56	28	I	EC.D.EXT					
	5	31	29	III	EC.D.EXT		3	44	7	II	OM.F.INT	23	0	12	I	EC.D.INT					
	5	42	43	III	EC.D.INT		3	48	13	II	OM.F.EXT	23	22	27	III	OM.D.EXT					
	8	4	43	I	EC.D.PEN		4	56	13	II	PA.F.INT	23	33	21	III	OM.D.INT					
	8	5	28	I	EC.D.EXT		5	0	16	II	PA.F.EXT	29	1	51	32	I	OC.F.INT				
	8	9	13	I	EC.D.INT		15	30	18	I	EC.D.PEN		1	55	15	I	OC.F.EXT				
	10	23	12	III	OC.F.INT		15	31	3	I	EC.D.EXT		2	8	43	III	PA.D.EXT				
	10	34	1	III	OC.F.EXT		15	34	48	I	EC.D.INT		2	12	17	III	OM.F.INT				
	10	50	26	I	OC.F.INT		18	21	9	I	OC.F.INT		2	19	26	III	PA.D.INT				
	10	54	10	I	OC.F.EXT	18	24	53	I	OC.F.EXT	2		23	13	III	OM.F.EXT					
	19	5	14	9	I	OM.D.EXT	24	12	39	23	I		OM.D.EXT	5	0	21	III	PA.F.INT			
		5	17	52	I	OM.D.INT		12	43	6	I		OM.D.INT	5	11	3	III	PA.F.EXT			
5		45	53	I	PA.D.EXT	13		16	6	I	PA.D.EXT		20	4	39	I	OM.D.EXT				
5		49	35	I	PA.D.INT	13		19	48	I	PA.D.INT		20	8	22	I	OM.D.INT				
7		27	47	I	OM.F.INT	14		53	3	I	OM.F.INT		20	46	11	I	PA.D.EXT				
7		31	30	I	OM.F.EXT	14		56	46	I	OM.F.EXT		20	49	53	I	PA.D.INT				
7		59	18	I	PA.F.INT	15		29	35	I	PA.F.INT	22	18	20	I	OM.F.INT					
8		3	1	I	PA.F.EXT	15		33	17	I	PA.F.EXT	22	22	3	I	OM.F.EXT					
11		42	6	II	OM.D.EXT	19		13	2	II	EC.D.PEN	22	59	44	I	PA.F.INT					
11		46	12	II	OM.D.INT	19		14	34	II	EC.D.EXT	23	3	26	I	PA.F.EXT					
12		47	16	II	PA.D.EXT	19		18	38	II	EC.D.INT	30	3	35	43	II	OM.D.EXT				
12		51	21	II	PA.D.INT	23		11	2	II	OC.F.INT		3	39	48	II	OM.D.INT				
14	26	20	II	OM.F.INT	23	15	3	II	OC.F.EXT	5	0		41	II	PA.D.EXT						
14	30	26	II	OM.F.EXT	25	9	25	45	III	EC.D.PEN	5		4	44	II	PA.D.INT					
15	31	34	II	PA.F.INT		9	29	33	III	EC.D.EXT	6		20	4	II	OM.F.INT					
15	35	39	II	PA.F.EXT		9	40	43	III	EC.D.INT	6		24	9	II	OM.F.EXT					
20	2	33	17	I		EC.D.PEN	9	58	45	I	EC.D.PEN		7	45	19	II	PA.F.INT				
	2	34	1	I		EC.D.EXT	9	59	30	I	EC.D.EXT		7	49	22	II	PA.F.EXT				
	2	37	46	I		EC.D.INT	10	3	14	I	EC.D.INT		17	24	15	I	EC.D.PEN				
	5	20	43	I		OC.F.INT	12	51	17	I	OC.F.INT		17	25	0	I	EC.D.EXT				
	5	24	26	I		OC.F.EXT	12	55	0	I	OC.F.EXT		17	28	44	I	EC.D.INT				
	23	42	33	I		OM.D.EXT	14	50	15	III	OC.F.INT		20	21	41	I	OC.F.INT				
	23	46	16	I		OM.D.INT	15	0	58	III	OC.F.EXT	20	25	24	I	OC.F.EXT					
	21	0	15	58		I	PA.D.EXT	26	7	7	50	I	OM.D.EXT	31	14	33	3	I	OM.D.EXT		
		0	19	40		I	PA.D.INT		7	11	33	I	OM.D.INT		14	36	46	I	OM.D.INT		
		1	56	12	I	OM.F.INT	7		46	11	I	PA.D.EXT	15		16	8	I	PA.D.EXT			
		1	59	55	I	OM.F.EXT	7		49	53	I	PA.D.INT	15		19	50	I	PA.D.INT			
		2	29	25	I	PA.F.INT	9		21	30	I	OM.F.INT	16		46	43	I	OM.F.INT			
2		33	7	I	PA.F.EXT	9	25		13	I	OM.F.EXT	16	50		26	I	OM.F.EXT				
5		55	59	II	EC.D.PEN	9	59		41	I	PA.F.INT	17	29		41	I	PA.F.INT				
5		57	30	II	EC.D.EXT	10	3		24	I	PA.F.EXT	17	33		24	I	PA.F.EXT				
6		1	34	II	EC.D.INT	14	18		5	II	OM.D.EXT	21	47		14	II	EC.D.PEN				
9		46	55	II	OC.F.INT	14	22		10	II	OM.D.INT	21	48		46	II	EC.D.EXT				
9		50	57	II	OC.F.EXT	15	36		37	II	PA.D.EXT	21	52		50	II	EC.D.INT				
19		24	20	III	OM.D.EXT	15	40		40	II	PA.D.INT										
19	35	18	III	OM.D.INT	17	2	23	II	OM.F.INT												

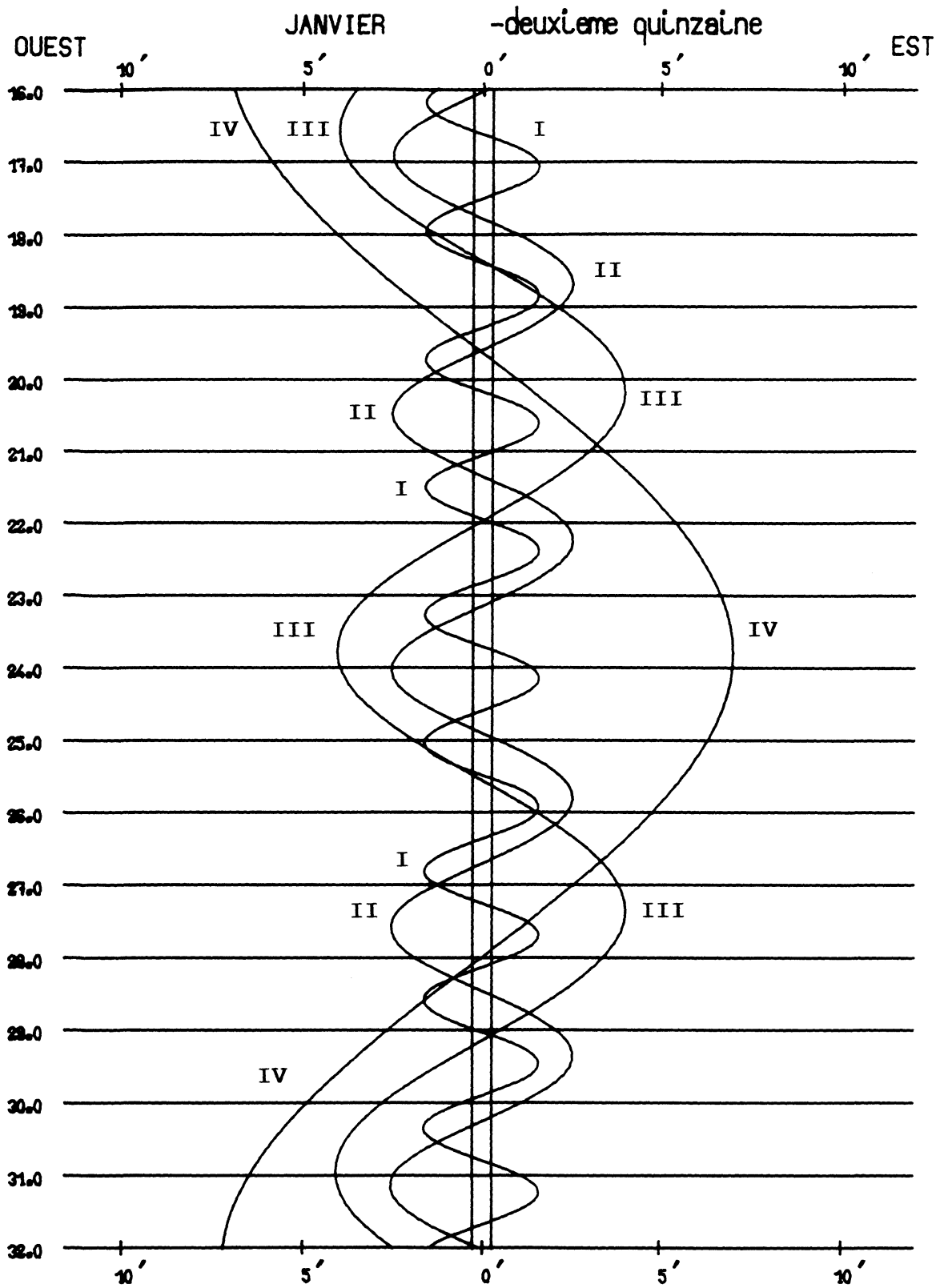

Dans le sens OUEST-EST, les satellites passent au-delà de Jupiter

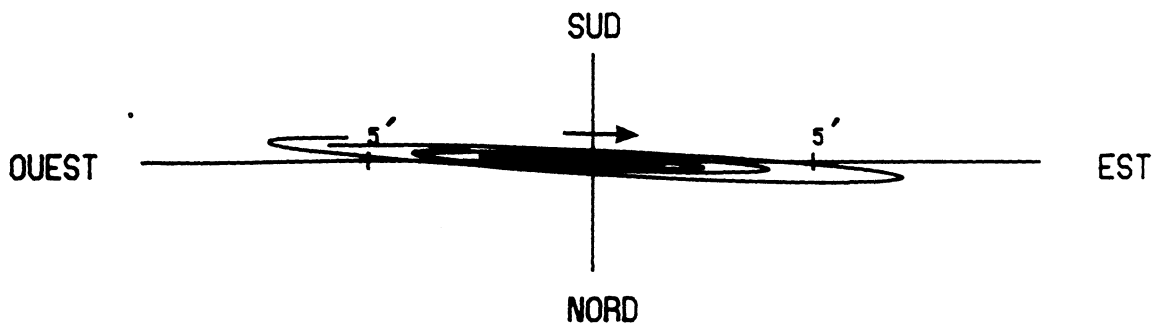

ORBITES APPARENTES

1996 - PHÉNOMÈNES DES SATELLITES GALILÉENS DE JUPITER
(Temps Terrestre)

PREMIÈRE QUINZAINE DE FÉVRIER

jour	h	m	s	SAT.	TYPE	jour	h	m	s	SAT.	TYPE	jour	h	m	s	SAT.	TYPE
1	1	58	51	II	OC.F.INT	22	49	39	I	PA.D.INT	6	15	29	I	PA.D.EXT		
	2	52	II	OC.F.EXT								6	19	11	I	PA.D.INT	
	11	52	40	I	EC.D.PEN	6	0	11	59	I	OM.F.INT	7	37	12	I	OM.F.INT	
	11	53	25	I	EC.D.EXT		0	15	42	I	OM.F.EXT	7	40	55	I	OM.F.EXT	
	11	57	9	I	EC.D.INT		0	59	33	I	PA.F.INT	8	29	7	I	PA.F.INT	
	13	24	30	III	EC.D.PEN		1	3	15	I	PA.F.EXT	8	32	49	I	PA.F.EXT	
	13	28	18	III	EC.D.EXT		6	11	27	II	OM.D.EXT	13	38	32	II	EC.D.PEN	
	13	39	23	III	EC.D.INT		6	15	31	II	OM.D.INT	13	40	3	II	EC.D.EXT	
	14	51	41	I	OC.F.INT		7	48	40	II	PA.D.EXT	13	44	7	II	EC.D.INT	
	14	55	24	I	OC.F.EXT		7	52	42	II	PA.D.INT	18	9	13	II	OC.F.INT	
	16	11	46	III	EC.F.INT		8	55	50	II	OM.F.INT	18	13	13	II	OC.F.EXT	
	16	22	52	III	EC.F.EXT		8	59	54	II	OM.F.EXT						
	16	23	25	III	OC.D.EXT		10	33	26	II	PA.F.INT	12	2	43	21	I	EC.D.PEN
	16	26	40	III	EC.F.PEN		10	37	28	II	PA.F.EXT	2	2	44	6	I	EC.D.EXT
	16	34	1	III	OC.D.INT		19	18	5	I	EC.D.PEN	2	47	49	I	EC.D.INT	
	19	16	44	III	OC.F.INT		19	18	50	I	EC.D.EXT	5	51	23	I	OC.F.INT	
	19	27	20	III	OC.F.EXT		19	22	34	I	EC.D.INT	5	55	5	I	OC.F.EXT	
							22	21	44	I	OC.F.INT	7	18	15	III	OM.D.EXT	
							22	25	26	I	OC.F.EXT	7	29	0	III	OM.D.INT	
2	9	1	30	I	OM.D.EXT							10	9	44	III	OM.F.INT	
	9	5	13	I	OM.D.INT							10	20	33	III	OM.F.EXT	
	9	46	8	I	PA.D.EXT	7	16	26	41	I	OM.D.EXT	10	53	47	III	PA.D.EXT	
	9	49	50	I	PA.D.INT		16	30	24	I	OM.D.INT	10	53	47	III	PA.D.EXT	
	11	15	11	I	OM.F.INT		17	15	47	I	PA.D.EXT	11	4	18	III	PA.D.INT	
	11	18	54	I	OM.F.EXT		17	19	30	I	PA.D.INT	13	48	1	III	PA.F.INT	
	11	59	42	I	PA.F.INT		18	40	22	I	OM.F.INT	13	58	30	III	PA.F.EXT	
	12	3	24	I	PA.F.EXT		18	44	5	I	OM.F.EXT	23	51	55	I	OM.D.EXT	
	16	53	51	II	OM.D.EXT		19	29	24	I	PA.F.INT	23	55	38	I	OM.D.INT	
	16	57	56	II	OM.D.INT		19	33	6	I	PA.F.EXT						
	18	25	1	II	PA.D.EXT							13	0	45	17	I	PA.D.EXT
	18	29	4	II	PA.D.INT							0	48	59	I	PA.D.INT	
	19	38	12	II	OM.F.INT	8	0	21	27	II	EC.D.PEN	2	5	37	I	OM.F.INT	
	19	42	17	II	OM.F.EXT		0	22	59	II	EC.D.EXT	2	9	20	I	OM.F.EXT	
	19	42	17	II	OM.F.EXT		0	27	3	II	EC.D.INT	2	9	20	I	OM.F.EXT	
	21	9	42	II	PA.F.INT		4	46	1	II	OC.F.INT	2	58	56	I	PA.F.INT	
	21	13	44	II	PA.F.EXT		4	50	2	II	OC.F.EXT	3	2	38	I	PA.F.EXT	
							13	46	29	I	EC.D.PEN	8	46	57	II	OM.D.EXT	
							13	47	14	I	EC.D.EXT	8	51	0	II	OM.D.INT	
3	6	21	10	I	EC.D.PEN		13	50	57	I	EC.D.INT	10	35	32	II	PA.D.EXT	
	6	21	54	I	EC.D.EXT		16	51	37	I	OC.F.INT	10	39	33	II	PA.D.INT	
	6	25	38	I	EC.D.INT		16	55	20	I	OC.F.EXT	11	31	20	II	OM.F.INT	
	9	21	45	I	OC.F.INT		17	22	47	III	EC.D.PEN	11	35	24	II	OM.F.EXT	
	9	25	28	I	OC.F.EXT		17	26	34	III	EC.D.EXT	13	20	25	II	PA.F.INT	
							17	37	34	III	EC.D.INT	13	24	25	II	PA.F.EXT	
4	3	29	53	I	OM.D.EXT		20	11	3	III	EC.F.INT	19	14	5	IV	PA.D.EXT	
	3	33	36	I	OM.D.INT		20	22	4	III	EC.F.EXT	19	53	42	IV	PA.D.INT	
	4	16	2	I	PA.D.EXT		20	25	51	III	EC.F.PEN	20	32	3	IV	PA.F.INT	
	4	19	44	I	PA.D.INT		20	46	21	III	OC.D.EXT	21	11	20	IV	PA.F.EXT	
	5	43	34	I	OM.F.INT		20	56	51	III	OC.D.INT	21	11	50	I	EC.D.PEN	
	5	47	17	I	OM.F.EXT		23	41	6	III	OC.F.INT	21	12	35	I	EC.D.EXT	
	6	29	37	I	PA.F.INT		23	51	37	III	OC.F.EXT	21	16	18	I	EC.D.INT	
	6	33	19	I	PA.F.EXT												
	11	4	17	II	EC.D.PEN												
	11	5	49	II	EC.D.EXT												
	11	9	53	II	EC.D.INT	9	10	55	8	I	OM.D.EXT	14	0	21	15	I	OC.F.INT
	15	22	25	II	OC.F.INT		10	58	50	I	OM.D.INT	0	24	58	I	OC.F.EXT	
	15	26	26	II	OC.F.EXT		11	45	41	I	PA.D.EXT	18	20	17	I	OM.D.EXT	
							11	49	23	I	PA.D.INT	18	24	0	I	OM.D.INT	
							13	8	49	I	OM.F.INT	19	15	0	I	PA.D.EXT	
5	0	49	35	I	EC.D.PEN		13	12	32	I	OM.F.EXT	19	18	42	I	PA.D.INT	
	0	50	20	I	EC.D.EXT		13	59	19	I	PA.F.INT	19	18	42	I	PA.D.INT	
	0	54	4	I	EC.D.INT		14	3	1	I	PA.F.EXT	20	33	59	I	OM.F.INT	
	3	20	24	III	OM.D.EXT		19	29	28	II	OM.D.EXT	20	37	42	I	OM.F.EXT	
	3	31	13	III	OM.D.INT		19	33	32	II	OM.D.INT	21	28	40	I	PA.F.INT	
	3	51	43	I	OC.F.INT		21	12	27	II	PA.D.EXT	21	32	22	I	PA.F.EXT	
	3	55	26	I	OC.F.EXT		21	16	28	II	PA.D.INT						
	5	27	0	IV	OC.F.INT		22	13	50	II	OM.F.INT	15	2	55	47	II	EC.D.PEN
	6	11	4	III	OM.F.INT		22	17	54	II	OM.F.EXT	2	57	19	II	EC.D.EXT	
	6	21	56	III	OM.F.EXT		23	57	15	II	PA.F.INT	3	1	22	II	EC.D.INT	
	6	32	5	III	PA.D.EXT							7	32	29	II	OC.F.INT	
	6	42	42	III	PA.D.INT							7	36	29	II	OC.F.EXT	
	9	25	2	III	PA.F.INT	10	0	1	16	II	PA.F.EXT	15	40	12	I	EC.D.PEN	
	9	35	37	III	PA.F.EXT		8	14	57	I	EC.D.PEN	15	40	57	I	EC.D.EXT	
	10	59	37	IV	OC.D.EXT		8	15	42	I	EC.D.EXT	15	44	40	I	EC.D.INT	
	12	49	22	IV	OC.F.EXT		8	19	25	I	EC.D.INT	18	51	1	I	OC.F.INT	
	18	10	28	IV	OC.D.INT		11	21	32	I	OC.F.INT	18	54	43	I	OC.F.EXT	
	21	58	18	I	OM.D.EXT		11	25	15	I	OC.F.EXT	21	21	33	III	EC.D.PEN	
	22	2	1	I	OM.D.INT							21	25	18	III	EC.D.EXT	
	22	45	57	I	PA.D.EXT	11	5	23	30	I	OM.D.EXT	21	36	14	III	EC.D.INT	
							5	27	13	I	OM.D.INT						

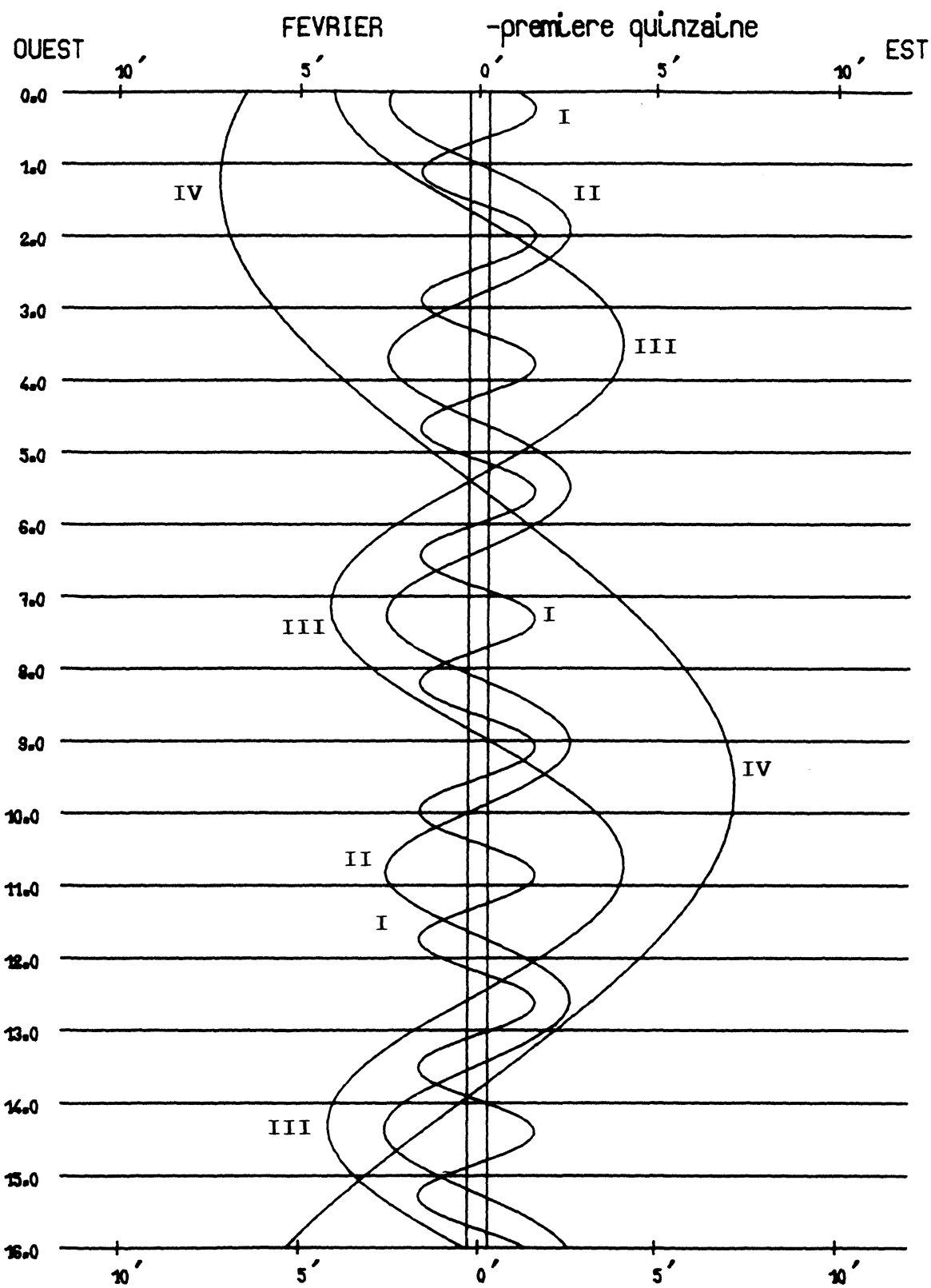

Dans le sens OUEST-EST, les satellites passent au-delà de Jupiter

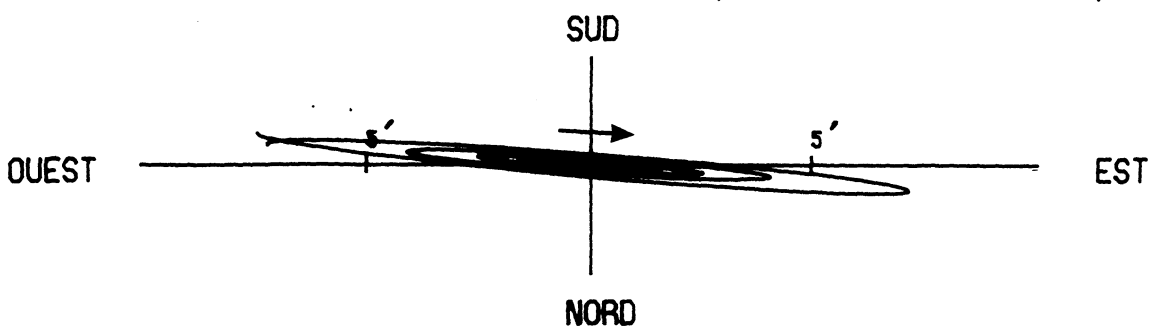

ORBITES APPARENTES

1996 - PHÉNOMÈNES DES SATELLITES GALILÉENS DE JUPITER
(Temps Terrestre)

DEUXIÈME QUINZAINE DE FÉVRIER																	
jour	h	m	s	SAT.	TYPE	jour	h	m	s	SAT.	TYPE	jour	h	m	s	SAT.	TYPE
16	0	10	48	III	EC.F.INT	13	25	10	II	PA.D.INT	9	14	22	I	OM.D.INT		
	0	21	44	III	EC.F.EXT	14	6	38	II	OM.F.INT	10	12	53	I	PA.D.EXT		
	0	25	29	III	EC.F.PEN	14	10	41	II	OM.F.EXT	10	16	35	I	PA.D.INT		
	1	7	54	III	OC.D.EXT	16	6	9	II	PA.F.INT	11	24	22	I	OM.F.INT		
	1	18	19	III	OC.D.INT	16	10	8	II	PA.F.EXT	11	28	5	I	OM.F.EXT		
	4	4	4	III	OC.F.INT	23	5	29	I	EC.D.PEN	12	26	37	I	PA.F.INT		
	4	14	29	III	OC.F.EXT	23	6	13	I	EC.D.EXT	12	30	19	I	PA.F.EXT		
	12	48	44	I	OM.D.EXT	23	9	57	I	EC.D.INT	18	47	17	II	EC.D.PEN		
	12	52	26	I	OM.D.INT						18	48	49	II	EC.D.EXT		
	13	44	47	I	PA.D.EXT	21	2	20	12	I	OC.F.INT	18	52	51	II	EC.D.INT	
	13	48	29	I	PA.D.INT	2	23	54	I	OC.F.EXT	23	40	18	II	OC.F.INT		
	15	2	25	I	OM.F.INT	20	13	52	I	OM.D.EXT	23	44	17	II	OC.F.EXT		
	15	6	8	I	OM.F.EXT	20	17	35	I	OM.D.INT							
	15	58	27	I	PA.F.INT	21	13	43	I	PA.D.EXT	26	6	30	36	I	EC.D.PEN	
	16	2	9	I	PA.F.EXT	21	17	25	I	PA.D.INT	6	31	21	I	EC.D.EXT		
	22	4	49	II	OM.D.EXT	22	27	34	I	OM.F.INT	6	35	4	I	EC.D.EXT		
	22	8	53	II	OM.D.INT	22	31	17	I	OM.F.EXT	9	48	56	I	OC.F.INT		
	23	58	41	II	PA.D.EXT	23	27	26	I	PA.F.INT	9	52	38	I	OC.F.EXT		
						23	31	8	I	PA.F.EXT	15	15	5	III	OM.D.EXT		
17	0	2	41	II	PA.D.INT						15	25	42	III	OM.D.INT		
	0	49	12	II	OM.F.INT	22	5	30	10	II	EC.D.PEN	18	8	14	III	OM.F.INT	
	0	53	15	II	OM.F.EXT	5	31	42	II	EC.D.EXT	18	18	55	III	OM.F.EXT		
	2	43	35	II	PA.F.INT	5	35	45	II	EC.D.INT	19	32	19	III	PA.D.EXT		
	2	47	35	II	PA.F.EXT	6	51	36	IV	OC.D.EXT	19	42	39	III	PA.D.INT		
	10	8	39	I	EC.D.PEN	7	20	17	IV	OC.D.INT	22	28	59	III	PA.F.INT		
	10	9	23	I	EC.D.EXT	8	38	28	IV	OC.F.INT	22	39	17	III	PA.F.EXT		
	10	13	7	I	EC.D.INT	9	7	9	IV	OC.F.EXT							
	13	20	47	I	OC.F.INT	10	18	4	II	OC.F.INT	27	3	39	4	I	OM.D.EXT	
	13	24	29	I	OC.F.EXT	10	22	3	II	OC.F.EXT	3	42	47	I	OM.D.INT		
18	7	17	6	I	OM.D.EXT	17	33	50	I	EC.D.PEN	4	42	26	I	PA.D.EXT		
	7	20	48	I	OM.D.INT	17	34	34	I	EC.D.EXT	4	46	8	I	PA.D.INT		
	8	14	27	I	PA.D.EXT	17	38	18	I	EC.D.INT	5	52	47	I	OM.F.INT		
	8	18	9	I	PA.D.INT	20	49	48	I	OC.F.INT	5	56	30	I	OM.F.EXT		
	9	30	48	I	OM.F.INT	20	53	30	I	OC.F.EXT	6	56	10	I	PA.F.INT		
	9	34	31	I	OM.F.EXT						6	59	52	I	PA.F.EXT		
	10	28	8	I	PA.F.INT	23	1	19	22	III	EC.D.PEN	13	57	20	II	OM.D.EXT	
	10	31	50	I	PA.F.EXT	1	23	6	III	EC.D.EXT	14	1	22	II	OM.D.INT		
	16	12	52	II	EC.D.PEN	1	33	58	III	EC.D.INT	16	5	30	II	PA.D.EXT		
	16	14	24	II	EC.D.EXT	4	9	36	III	EC.F.INT	16	9	29	II	PA.D.INT		
	16	18	27	II	EC.D.INT	4	20	28	III	EC.F.EXT	16	41	44	II	OM.F.INT		
	20	55	15	II	OC.F.INT	4	24	12	III	EC.F.PEN	16	45	46	II	OM.F.EXT		
	20	59	14	II	OC.F.EXT	5	26	29	III	OC.D.EXT	18	50	32	II	PA.F.INT		
19	4	37	1	I	EC.D.PEN	5	36	48	III	OC.D.INT	18	54	31	II	PA.F.EXT		
	4	37	46	I	EC.D.EXT	8	24	1	III	OC.F.INT							
	4	41	29	I	EC.D.INT	8	34	20	III	OC.F.EXT	28	0	59	2	I	EC.D.PEN	
	7	50	28	I	OC.F.INT	14	42	18	I	OM.D.EXT	0	59	47	I	EC.D.EXT		
	7	54	11	I	OC.F.EXT	14	46	1	I	OM.D.INT	1	3	30	I	EC.D.INT		
	11	16	16	III	OM.D.EXT	15	43	22	I	PA.D.EXT	4	18	29	I	OC.F.INT		
	11	26	57	III	OM.D.INT	15	47	4	I	PA.D.INT	4	22	11	I	OC.F.EXT		
	14	8	34	III	OM.F.INT	16	56	0	I	OM.F.INT	22	7	25	I	OM.D.EXT		
	14	19	19	III	OM.F.EXT	16	59	43	I	OM.F.EXT	22	11	8	I	OM.D.INT		
	15	13	43	III	PA.D.EXT	17	57	5	I	PA.F.INT	23	11	52	I	PA.D.EXT		
	15	24	9	III	PA.D.INT	18	0	47	I	PA.F.EXT	23	15	34	I	PA.D.INT		
	18	9	12	III	PA.F.INT												
	18	19	35	III	PA.F.EXT	24	0	40	1	II	OM.D.EXT	29	0	21	8	I	OM.F.INT
20	1	45	30	I	OM.D.EXT	0	44	3	II	OM.D.INT	0	24	51	I	OM.F.EXT		
	1	49	13	I	OM.D.INT	2	43	40	II	PA.D.EXT	1	25	37	I	PA.F.INT		
	2	44	8	I	PA.D.EXT	2	47	40	II	PA.D.INT	1	29	19	I	PA.F.EXT		
	2	47	50	I	PA.D.INT	3	24	23	II	OM.F.INT	8	4	39	II	EC.D.PEN		
	3	59	12	I	OM.F.INT	3	28	26	II	OM.F.EXT	8	6	11	II	EC.D.EXT		
	4	2	55	I	OM.F.EXT	5	28	39	II	PA.F.INT	8	10	14	II	EC.D.INT		
	4	57	50	I	PA.F.INT	5	32	38	II	PA.F.EXT	13	2	38	II	OC.F.INT		
	5	1	32	I	PA.F.EXT	12	2	15	I	EC.D.PEN	13	6	37	II	OC.F.EXT		
	11	22	14	II	OM.D.EXT	12	2	59	I	EC.D.EXT	19	27	22	I	EC.D.PEN		
	11	26	17	II	OM.D.INT	12	6	42	I	EC.D.INT	19	28	7	I	EC.D.EXT		
	13	21	10	II	PA.D.EXT	15	19	24	I	OC.F.INT	19	31	50	I	EC.D.INT		
						15	23	6	I	OC.F.EXT	22	47	55	I	OC.F.INT		
						25	9	10	40	I	OM.D.EXT	22	51	37	I	OC.F.EXT	

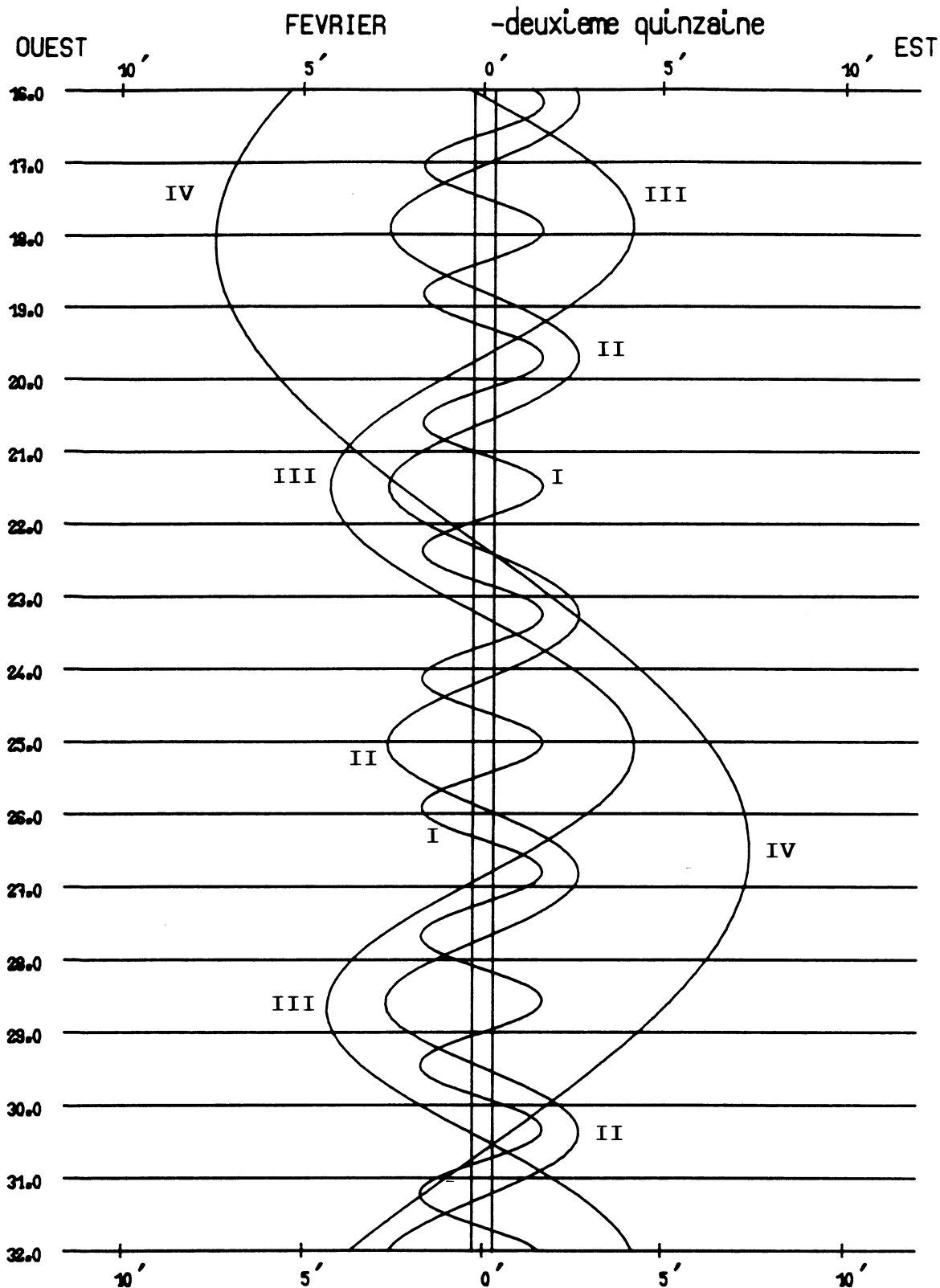

Dans le sens OUEST-EST ,les satellites passent au-dela de Jupiter

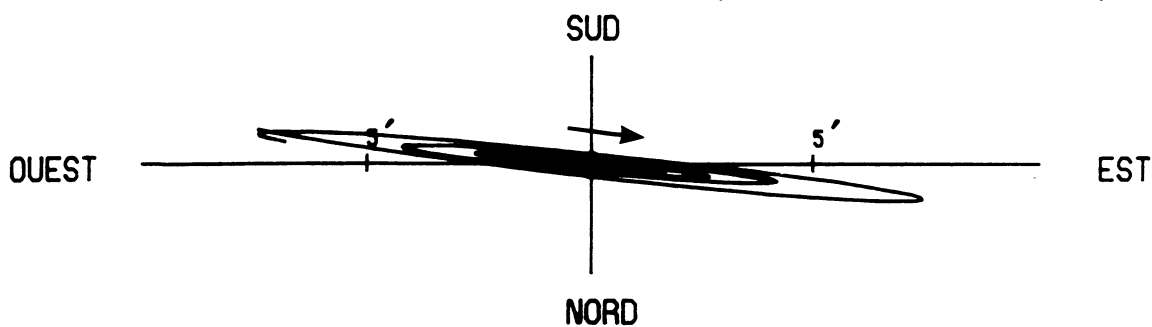

ORBITES APPARENTES

1996 - PHÉNOMÈNES DES SATELLITES GALILÉENS DE JUPITER
(Temps Terrestre)

PREMIÈRE QUINZAINE DE MARS

jour	h	m	s	SAT.	TYPE	jour	h	m	s	SAT.	TYPE	jour	h	m	s	SAT.	TYPE
1	5	16	57	III	EC.D.PEN	21	33	24	II	PA.F.INT	11	0	2	1	II	EC.D.INT	
	5	20	40	III	EC.D.EXT	21	37	22	II	PA.F.EXT	11	5	7	4	II	OC.F.INT	
	5	31	27	III	EC.D.INT							5	11	3	II	OC.F.EXT	
	8	8	10	III	EC.F.INT	6	2	52	31	I	EC.D.PEN	10	17	32	I	EC.D.PEN	
	8	18	58	III	EC.F.EXT	2	53	15	I	EC.D.EXT	10	18	16	I	EC.D.EXT		
	8	22	40	III	EC.F.PEN	2	56	58	I	EC.D.INT	10	21	59	I	EC.D.INT		
	9	42	28	III	OC.D.EXT	6	16	5	I	OC.F.INT	13	43	44	I	OC.F.INT		
	9	52	41	III	OC.D.INT	6	19	46	I	OC.F.EXT	13	47	25	I	OC.F.EXT		
	12	41	19	III	OC.F.INT							15	2	34	IV	EC.F.INT	
	12	51	32	III	OC.F.EXT	7	0	0	57	I	OM.D.EXT	23	12	5	III	OM.D.EXT	
	14	55	16	IV	PA.D.EXT	0	4	40	I	OM.D.INT	23	22	34	III	OM.D.INT		
	15	22	5	IV	PA.D.INT	1	9	24	I	PA.D.EXT							
	16	35	51	I	OM.D.EXT	1	13	5	I	PA.D.INT	12	2	6	53	III	OM.F.INT	
	16	39	34	I	OM.D.INT	2	14	41	I	OM.F.INT	2	17	26	III	OM.F.EXT		
	16	49	17	IV	PA.F.INT	2	18	24	I	OM.F.EXT	4	0	51	III	PA.D.EXT		
	17	15	48	IV	PA.F.EXT	3	23	11	I	PA.F.INT	4	11	1	III	PA.D.INT		
	17	41	22	I	PA.D.EXT	3	26	53	I	PA.F.EXT	6	59	44	III	PA.F.INT		
	17	45	3	I	PA.D.INT	10	39	15	II	EC.D.PEN	7	9	51	III	PA.F.EXT		
	18	49	34	I	OM.F.INT	10	40	47	II	EC.D.EXT	7	26	8	I	OM.D.EXT		
	18	53	17	I	OM.F.EXT	10	44	50	II	EC.D.INT	7	29	51	I	OM.D.INT		
	19	55	8	I	PA.F.INT	15	46	4	II	OC.F.INT	8	37	8	I	PA.D.EXT		
	19	58	49	I	PA.F.EXT	15	50	3	II	OC.F.EXT	8	40	50	I	PA.D.INT		
						20	5	52	IV	EC.D.INT	9	39	54	I	OM.F.INT		
2	3	14	56	II	OM.D.EXT	21	20	50	I	EC.D.PEN	9	43	37	I	OM.F.EXT		
	3	18	58	II	OM.D.INT	21	21	34	I	EC.D.EXT	10	50	59	I	PA.F.INT		
	5	27	13	II	PA.D.EXT	21	25	17	I	EC.D.INT	10	54	40	I	PA.F.EXT		
	5	31	11	II	PA.D.INT						19	6	52	II	OM.D.EXT		
	5	59	19	II	OM.F.INT	8	0	45	20	I	OC.F.INT	19	10	53	II	OM.D.INT	
	6	3	21	II	OM.F.EXT	0	49	1	I	OC.F.EXT	21	29	37	II	PA.D.EXT		
	8	12	15	II	PA.F.INT	9	14	30	III	EC.D.PEN	21	33	34	II	PA.D.INT		
	8	16	13	II	PA.F.EXT	9	18	12	III	EC.D.EXT	21	51	18	II	OM.F.INT		
	13	55	46	I	EC.D.PEN	9	28	55	III	EC.D.INT	21	55	19	II	OM.F.EXT		
	13	56	30	I	EC.D.EXT	12	6	43	III	EC.F.INT							
	14	0	13	I	EC.D.INT	12	17	26	III	EC.F.EXT	13	0	14	44	II	PA.F.INT	
	17	17	21	I	OC.F.INT	12	21	8	III	EC.F.PEN	0	18	41	II	PA.F.EXT		
	17	21	3	I	OC.F.EXT	13	55	55	III	OC.D.EXT	4	45	55	I	EC.D.PEN		
						14	6	3	III	OC.D.INT	4	46	40	I	EC.D.EXT		
3	11	4	12	I	OM.D.EXT	16	56	2	III	OC.F.INT	4	50	22	I	EC.D.INT		
	11	7	55	I	OM.D.INT	17	6	11	III	OC.F.EXT	8	12	54	I	OC.F.INT		
	12	10	44	I	PA.D.EXT	18	29	23	I	OM.D.EXT	8	16	35	I	OC.F.EXT		
	12	14	26	I	PA.D.INT	18	33	5	I	OM.D.INT							
	13	17	56	I	OM.F.INT	19	38	43	I	PA.D.EXT	14	1	54	28	I	OM.D.EXT	
	13	21	39	I	OM.F.EXT	19	42	25	I	PA.D.INT	1	58	11	I	OM.D.INT		
	14	24	30	I	PA.F.INT	20	43	7	I	OM.F.INT	3	6	14	I	PA.D.EXT		
	14	28	12	I	PA.F.EXT	20	46	50	I	OM.F.EXT	3	9	56	I	PA.D.INT		
	21	21	49	II	EC.D.PEN	21	52	32	I	PA.F.INT	4	8	14	I	OM.F.INT		
	21	23	21	II	EC.D.EXT	21	56	13	I	PA.F.EXT	4	11	57	I	OM.F.EXT		
	21	27	24	II	EC.D.INT						5	20	5	I	PA.F.INT		
						9	5	49	40	II	OM.D.EXT	5	23	47	I	PA.F.EXT	
4	2	24	18	II	OC.F.INT	5	53	41	II	OM.D.INT	13	13	58	II	EC.D.PEN		
	2	28	17	II	OC.F.EXT	8	9	15	II	PA.D.EXT	13	15	30	II	EC.D.EXT		
	8	24	6	I	EC.D.PEN	8	13	12	II	PA.D.INT	13	19	32	II	EC.D.INT		
	8	24	51	I	EC.D.EXT	8	34	4	II	OM.F.INT	18	28	12	II	OC.F.INT		
	8	28	34	I	EC.D.INT	8	38	5	II	OM.F.EXT	18	32	10	II	OC.F.EXT		
	11	46	42	I	OC.F.INT	10	54	19	II	PA.F.INT	23	14	13	I	EC.D.PEN		
	11	50	24	I	OC.F.EXT	10	58	17	II	PA.F.EXT	23	14	58	I	EC.D.EXT		
	19	13	22	III	OM.D.EXT	15	28	21	IV	EC.D.PEN	23	18	40	I	EC.D.INT		
	19	23	55	III	OM.D.INT	15	49	12	I	EC.D.PEN							
	22	7	21	III	OM.F.INT	15	49	57	I	EC.D.EXT	15	2	41	57	I	OC.F.INT	
	22	17	58	III	OM.F.EXT	15	51	31	IV	EC.F.EXT	2	45	38	I	OC.F.EXT		
	23	47	47	III	PA.D.EXT	15	53	39	I	EC.D.INT	13	12	11	III	EC.D.PEN		
	23	58	2	III	PA.D.INT	17	1	58	IV	EC.D.EXT	13	15	51	III	EC.D.EXT		
						17	25	7	IV	EC.F.PEN	13	26	30	III	EC.D.INT		
5	2	45	36	III	PA.F.INT	19	14	34	I	OC.F.INT	16	5	23	III	EC.F.INT		
	2	55	49	III	PA.F.EXT	19	18	15	I	OC.F.EXT	16	16	2	III	EC.F.EXT		
	5	32	37	I	OM.D.EXT						16	19	43	III	EC.F.PEN		
	5	36	19	I	OM.D.INT	10	2	39	53	IV	OC.D.INT	16	19	43	III	OC.D.EXT	
	6	40	7	I	PA.D.EXT	4	52	24	IV	OC.F.EXT	18	6	37	III	OC.D.EXT		
	6	43	49	I	PA.D.INT	12	57	44	I	OM.D.EXT	18	16	40	III	OC.D.INT		
	7	46	20	I	OM.F.INT	13	1	27	I	OM.D.INT	20	22	54	I	OM.D.EXT		
	7	50	3	I	OM.F.EXT	14	7	56	I	PA.D.EXT	20	26	36	I	OM.D.INT		
	8	53	54	I	PA.F.INT	14	11	37	I	PA.D.INT	21	7	56	III	OC.F.INT		
	8	57	36	I	PA.F.EXT	15	11	29	I	OM.F.INT	21	18	0	III	OC.F.EXT		
	16	32	11	II	OM.D.EXT	15	15	12	I	OM.F.EXT	21	35	23	I	PA.D.EXT		
	16	36	12	II	OM.D.INT	16	21	45	I	PA.F.INT	21	39	5	I	PA.D.INT		
	18	48	20	II	PA.D.EXT	16	25	26	I	PA.F.EXT	22	36	41	I	OM.F.INT		
	18	52	17	II	PA.D.INT	23	56	26	II	EC.D.PEN	22	40	23	I	OM.F.EXT		
	19	16	36	II	OM.F.INT	23	57	58	II	EC.D.EXT	23	49	15	I	PA.F.INT		
	19	20	37	II	OM.F.EXT						23	52	56	I	PA.F.EXT		

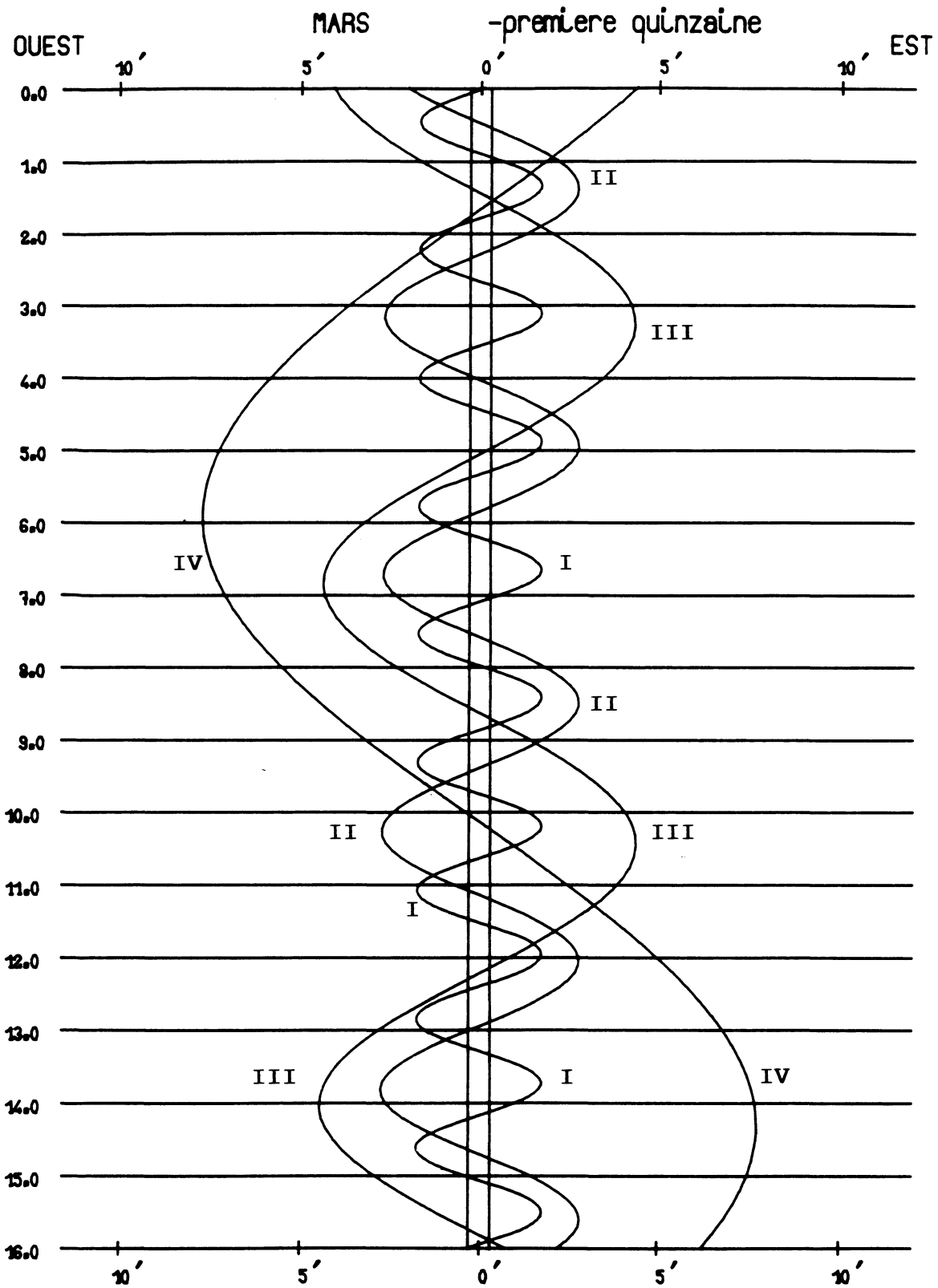

Dans le sens OUEST-EST, les satellites passent au-delà de Jupiter

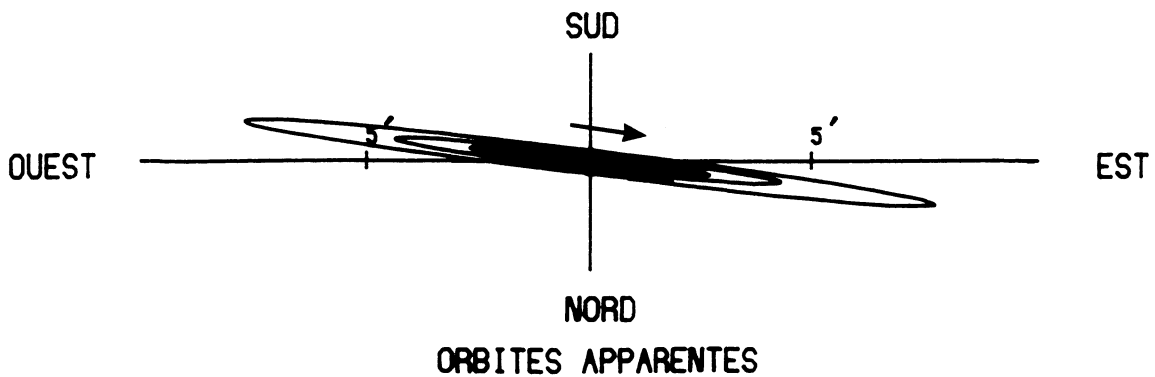

1996 - PHÉNOMÈNES DES SATELLITES GALILÉENS DE JUPITER
(Temps Terrestre)

DEUXIÈME QUINZAINE DE MARS																	
jour	h	m	s	SAT.	TYPE	jour	h	m	s	SAT.	TYPE	jour	h	m	s	SAT.	TYPE
16	8	24	12	II	OM.D.EXT							14	42	53	I	PA.F.INT	
	8	28	12	II	OM.D.INT							14	46	34	I	PA.F.EXT	
	10	49	39	II	PA.D.EXT							15	8	34	IV	EC.D.INT	
	10	53	36	II	PA.D.INT							15	16	48	III	PA.F.INT	
	11	8	37	II	OM.F.INT							15	26	46	III	PA.F.EXT	
	11	12	38	II	OM.F.EXT												
	13	34	47	II	PA.F.INT	22	1	7	33	I	EC.D.PEN	27	0	15	33	II	OM.D.EXT
	13	38	43	II	PA.F.EXT		1	8	18	I	EC.D.EXT		0	19	33	II	OM.D.INT
	17	42	35	I	EC.D.PEN		1	12	0	I	EC.D.INT		2	46	55	II	PA.D.EXT
	17	43	19	I	EC.D.EXT		4	37	45	I	OC.F.INT		2	50	50	II	PA.D.INT
	17	47	1	I	EC.D.INT		4	41	26	I	OC.F.EXT		3	0	5	II	OM.F.INT
	21	11	0	I	OC.F.INT		17	10	35	III	EC.D.PEN		3	4	5	II	OM.F.EXT
	21	14	41	I	OC.F.EXT		17	14	15	III	EC.D.EXT		5	32	7	II	PA.F.INT
							17	24	50	III	EC.D.INT		5	36	2	II	PA.F.EXT
17	14	51	15	I	OM.D.EXT		20	4	47	III	EC.F.INT		8	32	33	I	EC.D.PEN
	14	54	57	I	OM.D.INT		20	15	23	III	EC.F.EXT		8	33	17	I	EC.D.EXT
	16	4	24	I	PA.D.EXT		20	19	2	III	EC.F.PEN		8	36	59	I	EC.D.INT
	16	8	6	I	PA.D.INT		22	14	53	III	OC.D.EXT		12	4	2	I	OC.F.INT
	17	5	2	I	OM.F.INT		22	16	24	I	OM.D.EXT		12	7	43	I	OC.F.EXT
	17	8	45	I	OM.F.EXT		22	20	6	I	OM.D.INT						
	18	18	17	I	PA.F.INT		22	24	52	III	OC.D.INT	28	5	41	28	I	OM.D.EXT
	18	21	58	I	PA.F.EXT		23	31	17	I	PA.D.EXT		5	45	11	I	OM.D.INT
	22	37	18	IV	OM.D.EXT		23	34	58	I	PA.D.INT		6	57	36	I	PA.D.EXT
	23	13	38	IV	OM.D.INT								7	1	18	I	PA.D.INT
	23	59	5	IV	OM.F.INT	23	0	30	14	I	OM.F.INT		7	55	22	I	OM.F.INT
							0	33	57	I	OM.F.EXT		7	59	5	I	OM.F.EXT
18	0	37	15	IV	OM.F.EXT		1	17	19	III	OC.F.INT		9	11	35	I	PA.F.INT
	2	31	11	II	EC.D.PEN		1	27	19	III	OC.F.EXT		9	15	16	I	PA.F.EXT
	2	32	43	II	EC.D.EXT		1	45	12	I	PA.F.INT		18	23	47	II	EC.D.PEN
	2	36	46	II	EC.D.INT		1	48	54	I	PA.F.EXT		18	25	20	II	EC.D.EXT
	7	48	29	II	OC.F.INT		10	58	30	II	OM.D.EXT		18	29	21	II	EC.D.INT
	7	52	27	II	OC.F.EXT		11	2	30	II	OM.D.INT		23	48	1	II	OC.F.INT
	10	5	4	IV	PA.D.EXT		13	28	17	II	PA.D.EXT		23	51	59	II	OC.F.EXT
	10	27	17	IV	PA.D.INT		13	32	13	II	PA.D.INT						
	12	10	53	I	EC.D.PEN		13	42	59	II	OM.F.INT	29	3	0	50	I	EC.D.PEN
	12	11	38	I	EC.D.EXT		13	46	59	II	OM.F.EXT		3	1	34	I	EC.D.EXT
	12	15	20	I	EC.D.INT		16	13	27	II	PA.F.INT		3	5	16	I	EC.D.INT
	12	21	19	IV	PA.F.INT		16	17	23	II	PA.F.EXT		6	32	39	I	OC.F.INT
	12	43	17	IV	PA.F.EXT		19	35	53	I	EC.D.PEN		6	36	20	I	OC.F.EXT
	15	39	57	I	OC.F.INT		19	36	38	I	EC.D.EXT		21	8	33	III	EC.D.PEN
	15	43	38	I	OC.F.EXT		19	40	20	I	EC.D.INT		21	12	11	III	EC.D.EXT
							23	6	34	I	OC.F.INT		21	22	42	III	EC.D.INT
							23	10	15	I	OC.F.EXT						
19	3	10	1	III	OM.D.EXT							30	0	3	43	III	EC.F.INT
	3	20	26	III	OM.D.INT								0	9	54	I	OM.D.EXT
	6	5	40	III	OM.F.EXT	24	16	44	45	I	OM.D.EXT		0	13	36	I	OM.D.INT
	6	16	9	III	OM.F.INT		16	48	27	I	OM.D.INT		0	14	15	III	EC.F.EXT
	8	10	9	III	PA.D.EXT		18	0	6	I	PA.D.EXT		0	17	53	III	EC.F.PEN
	8	20	14	III	PA.D.INT		18	3	47	I	PA.D.INT		1	26	21	I	PA.D.EXT
	9	19	39	I	OM.D.EXT		18	58	36	I	OM.F.INT		1	30	2	I	PA.D.INT
	9	23	21	I	OM.D.INT		19	2	19	I	OM.F.EXT		2	19	7	III	OC.D.EXT
	10	33	26	I	PA.D.EXT		20	14	2	I	PA.F.INT		2	23	49	I	OM.F.INT
	10	37	7	I	PA.D.INT		20	17	44	I	PA.F.EXT		2	27	32	I	OM.F.EXT
	11	10	3	III	PA.F.INT								2	29	2	III	OC.D.INT
	11	20	5	III	PA.F.EXT	25	5	6	4	II	EC.D.PEN		3	40	21	I	PA.F.INT
	11	33	27	I	OM.F.INT		5	7	36	II	EC.D.EXT		3	44	2	I	PA.F.EXT
	11	37	10	I	OM.F.EXT		5	11	38	II	EC.D.INT		5	22	33	III	OC.F.INT
	12	47	20	I	PA.F.INT		10	28	22	II	OC.F.INT		5	32	29	III	OC.F.EXT
	12	51	1	I	PA.F.EXT		10	32	20	II	OC.F.EXT		13	32	39	II	OM.D.EXT
	21	41	18	II	OM.D.EXT		14	4	11	I	EC.D.PEN		13	36	38	II	OM.D.INT
	21	45	18	II	OM.D.INT		14	4	55	I	EC.D.EXT		16	5	5	II	PA.D.EXT
							14	8	38	I	EC.D.INT		16	9	1	II	PA.D.INT
20	0	9	10	II	PA.D.EXT		17	35	18	I	OC.F.INT		16	17	13	II	OM.F.INT
	0	13	6	II	PA.D.INT		17	38	59	I	OC.F.EXT		16	21	12	II	OM.F.EXT
	0	25	46	II	OM.F.INT								18	50	19	II	PA.F.INT
	0	29	47	II	OM.F.EXT								18	54	14	II	PA.F.EXT
	2	54	20	II	PA.F.INT	26	5	46	47	IV	EC.F.INT		21	29	9	I	EC.D.PEN
	2	58	16	II	PA.F.EXT		7	7	47	III	OM.D.EXT		21	29	53	I	EC.D.EXT
	6	39	16	I	EC.D.PEN		7	18	8	III	OM.D.INT		21	33	35	I	EC.D.INT
	6	40	0	I	EC.D.EXT		9	20	51	IV	EC.D.PEN						
	6	43	42	I	EC.D.INT		9	39	42	IV	EC.D.EXT						
	10	8	55	I	OC.F.INT		10	4	18	III	OM.F.INT						
	10	12	35	I	OC.F.EXT		10	14	43	III	OM.F.EXT	31	1	1	15	I	OC.F.INT
							11	13	9	I	OM.D.EXT		1	4	55	I	OC.F.EXT
							11	15	40	IV	EC.F.EXT		18	38	14	I	OM.D.EXT
							11	16	51	I	OM.D.INT		18	41	57	I	OM.D.INT
							11	34	31	IV	EC.F.PEN		19	54	57	I	PA.D.EXT
							12	15	57	III	PA.D.EXT		19	58	38	I	PA.D.INT
							12	25	58	III	PA.D.INT		20	52	11	I	OM.F.INT
							12	28	55	I	PA.D.EXT		20	55	53	I	OM.F.EXT
							12	32	37	I	PA.D.INT		22	8	58	I	PA.F.INT
							13	27	1	I	OM.F.INT		22	12	39	I	PA.F.EXT
							13	30	44	I	OM.F.EXT						

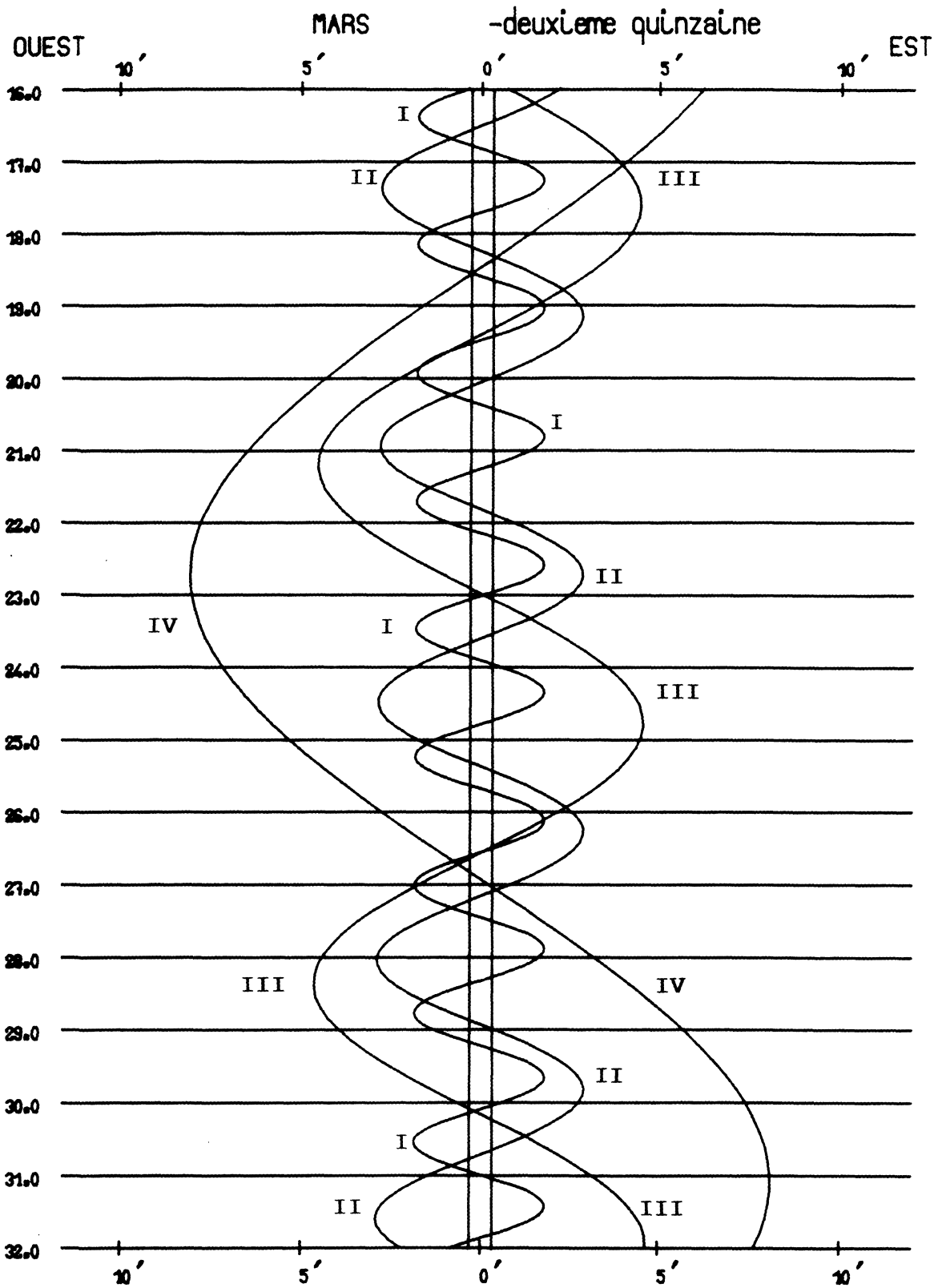

Dans le sens OUEST-EST, les satellites passent au-delà de Jupiter

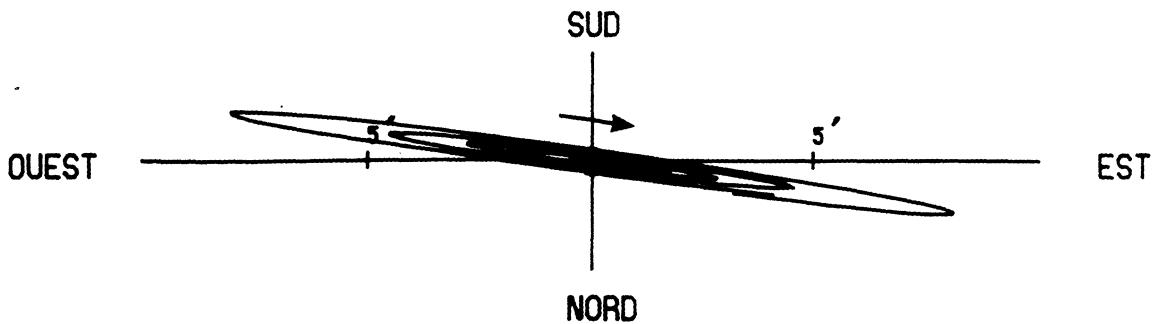

ORBITES APPARENTES

1996 - PHÉNOMÈNES DES SATELLITES GALILÉENS DE JUPITER
(Temps Terrestre)

PREMIÈRE QUINZAINE DE AVRIL																	
jour	h	m	s	SAT.	TYPE	jour	h	m	s	SAT.	TYPE	jour	h	m	s	SAT.	TYPE
1	7	41	4	II	EC.D.PEN	4	17	25	I	OM.F.INT	11	9	28	28	I	OM.D.EXT	
	7	42	36	II	EC.D.EXT	4	21	7	I	OM.F.EXT	9	32	10	I	OM.D.INT		
	7	46	38	II	EC.D.INT	5	34	37	I	PA.F.INT	10	45	30	I	PA.D.EXT		
	13	6	35	II	OC.F.INT	5	38	18	I	PA.F.EXT	10	49	11	I	PA.D.INT		
	13	10	33	II	OC.F.EXT	6	20	2	III	OC.D.EXT	11	42	35	I	OM.F.INT		
	15	57	26	I	EC.D.PEN	6	29	53	III	OC.D.INT	11	46	17	I	OM.F.EXT		
	15	58	11	I	EC.D.EXT	9	24	20	III	OC.F.INT	12	59	40	I	PA.F.INT		
	16	1	52	I	EC.D.INT	9	34	12	III	OC.F.EXT	13	3	21	I	PA.F.EXT		
	19	29	45	I	OC.F.INT	16	6	35	II	OM.D.EXT	23	34	10	II	EC.D.PEN		
	19	33	25	I	OC.F.EXT	16	10	33	II	OM.D.INT	23	35	42	II	EC.D.EXT		
						18	39	53	II	PA.D.EXT	23	39	44	II	EC.D.INT		
2	11	5	30	III	OM.D.EXT	18	43	48	II	PA.D.INT							
	11	15	48	III	OM.D.INT	18	51	16	II	OM.F.INT							
	13	6	38	I	OM.D.EXT	18	55	15	II	OM.F.EXT	12	5	0	54	II	OC.F.INT	
	13	10	21	I	OM.D.INT	21	25	10	II	PA.F.INT	5	4	51	II	OC.F.EXT		
	14	2	56	III	OM.F.INT	21	29	5	II	PA.F.EXT	6	47	16	I	EC.D.PEN		
	14	13	18	III	OM.F.EXT	23	22	23	I	EC.D.PEN	6	48	1	I	EC.D.EXT		
	14	23	33	I	PA.D.EXT	23	23	7	I	EC.D.EXT	6	51	42	I	EC.D.INT		
	14	27	14	I	PA.D.INT	23	26	49	I	EC.D.INT	10	19	36	I	OC.F.INT		
	15	20	37	I	OM.F.INT						10	23	16	I	OC.F.EXT		
	15	24	19	I	OM.F.EXT	7	2	54	58	I	OC.F.INT						
	16	18	15	III	PA.D.EXT	2	58	38	I	OC.F.EXT	13	3	56	54	I	OM.D.EXT	
	16	28	12	III	PA.D.INT	20	31	44	I	OM.D.EXT	4	0	36	I	OM.D.INT		
	16	37	36	I	PA.F.INT	20	35	26	I	OM.D.INT	5	4	37	III	EC.D.PEN		
	16	41	17	I	PA.F.EXT	21	48	54	I	PA.D.EXT	5	8	14	III	EC.D.EXT		
	19	20	1	III	PA.F.INT	21	52	35	I	PA.D.INT	5	13	46	I	PA.D.EXT		
	19	29	56	III	PA.F.EXT	22	45	47	I	OM.F.INT	5	17	28	I	PA.D.INT		
						22	49	30	I	OM.F.EXT	5	18	37	III	EC.D.INT		
3	2	49	36	II	OM.D.EXT	8	0	3	1	I	PA.F.INT	6	11	3	I	OM.F.INT	
	2	53	35	II	OM.D.INT	0	6	42	I	PA.F.EXT	6	14	46	I	OM.F.EXT		
	5	22	44	II	PA.D.EXT	10	16	15	II	EC.D.PEN	7	27	58	I	PA.F.INT		
	5	26	39	II	PA.D.INT	10	17	47	II	EC.D.EXT	7	31	39	I	PA.F.EXT		
	5	34	14	II	OM.F.INT	10	17	47	II	EC.D.EXT	8	1	43	III	EC.F.INT		
	5	38	13	II	OM.F.EXT	10	21	48	II	EC.D.INT	8	12	6	III	EC.F.EXT		
	8	7	59	II	PA.F.INT	15	43	3	II	OC.F.INT	8	15	42	III	EC.F.PEN		
	8	11	54	II	PA.F.EXT	15	47	0	II	OC.F.EXT	10	16	10	III	OC.D.EXT		
	10	25	47	I	EC.D.PEN	17	50	39	I	EC.D.PEN	10	25	58	III	OC.D.INT		
	10	26	32	I	EC.D.EXT	17	51	24	I	EC.D.EXT	13	21	15	III	OC.F.INT		
	10	30	13	I	EC.D.INT	17	55	5	I	EC.D.INT	13	31	4	III	OC.F.EXT		
	13	58	14	I	OC.F.INT	21	23	13	I	OC.F.INT	18	40	23	II	OM.D.EXT		
	14	1	54	I	OC.F.EXT	21	26	53	I	OC.F.EXT	18	44	21	II	OM.D.INT		
											21	12	39	II	PA.D.EXT		
4	7	34	58	I	OM.D.EXT	9	15	0	8	I	OM.D.EXT	21	16	33	II	PA.D.INT	
	7	38	40	I	OM.D.INT	15	3	24	III	OM.D.EXT	21	25	13	II	OM.F.INT		
	8	52	1	I	PA.D.EXT	15	3	50	I	OM.D.INT	21	29	11	II	OM.F.EXT		
	8	55	42	I	PA.D.INT	15	13	38	III	OM.D.INT	23	58	2	II	PA.F.INT		
	9	48	58	I	OM.F.INT	16	17	16	I	PA.D.EXT							
	9	52	40	I	OM.F.EXT	16	20	58	I	PA.D.INT	14	0	1	56	II	PA.F.EXT	
	11	6	5	I	PA.F.INT	17	14	14	I	OM.F.INT	1	15	35	I	EC.D.PEN		
	11	9	46	I	PA.F.EXT	17	17	56	I	OM.F.EXT	1	16	19	I	EC.D.EXT		
	20	58	55	II	EC.D.PEN	18	1	48	III	OM.F.INT	1	20	0	I	EC.D.INT		
	21	0	27	II	EC.D.EXT	18	12	6	III	OM.F.EXT	4	47	41	I	OC.F.INT		
	21	4	29	II	EC.D.INT	18	31	25	I	PA.F.INT	4	51	21	I	OC.F.EXT		
						18	35	6	I	PA.F.EXT	22	25	14	I	OM.D.EXT		
5	2	25	24	II	OC.F.INT	20	16	52	III	PA.D.EXT	22	28	56	I	OM.D.INT		
	2	29	21	II	OC.F.EXT	20	26	46	III	PA.D.INT	23	41	54	I	PA.D.EXT		
	4	54	4	I	EC.D.PEN	23	19	30	III	PA.F.INT	23	45	35	I	PA.D.INT		
	4	54	48	I	EC.D.EXT	23	29	21	III	PA.F.EXT							
	4	58	30	I	EC.D.INT												
	8	26	37	I	OC.F.INT	10	5	23	28	II	OM.D.EXT	15	0	39	26	I	OM.F.INT
	8	30	17	I	OC.F.EXT	5	27	26	II	OM.D.INT	0	43	8	I	OM.F.EXT		
						7	56	31	II	PA.D.EXT	1	56	7	I	PA.F.INT		
6	1	7	1	III	EC.D.PEN	8	0	26	II	PA.D.INT	1	59	48	I	PA.F.EXT		
	1	10	38	III	EC.D.EXT	8	8	14	II	OM.F.INT	12	51	32	II	EC.D.PEN		
	1	21	5	III	EC.D.INT	8	12	12	II	OM.F.EXT	12	53	5	II	EC.D.EXT		
	2	3	23	I	OM.D.EXT	10	41	51	II	PA.F.INT	12	57	6	II	EC.D.INT		
	2	7	6	I	OM.D.INT	10	45	45	II	PA.F.EXT	18	17	32	II	OC.F.INT		
	3	20	32	I	PA.D.EXT	12	19	0	I	EC.D.PEN	18	21	29	II	OC.F.EXT		
	3	24	13	I	PA.D.INT	12	19	44	I	EC.D.EXT	19	43	51	I	EC.D.PEN		
	4	3	9	III	EC.F.INT	12	23	26	I	EC.D.INT	19	44	36	I	EC.D.EXT		
	4	13	36	III	EC.F.EXT	15	51	28	I	OC.F.INT	19	48	17	I	EC.D.INT		
	4	17	13	III	EC.F.PEN	15	55	8	I	OC.F.EXT	23	15	41	I	OC.F.INT		
											23	19	21	I	OC.F.EXT		

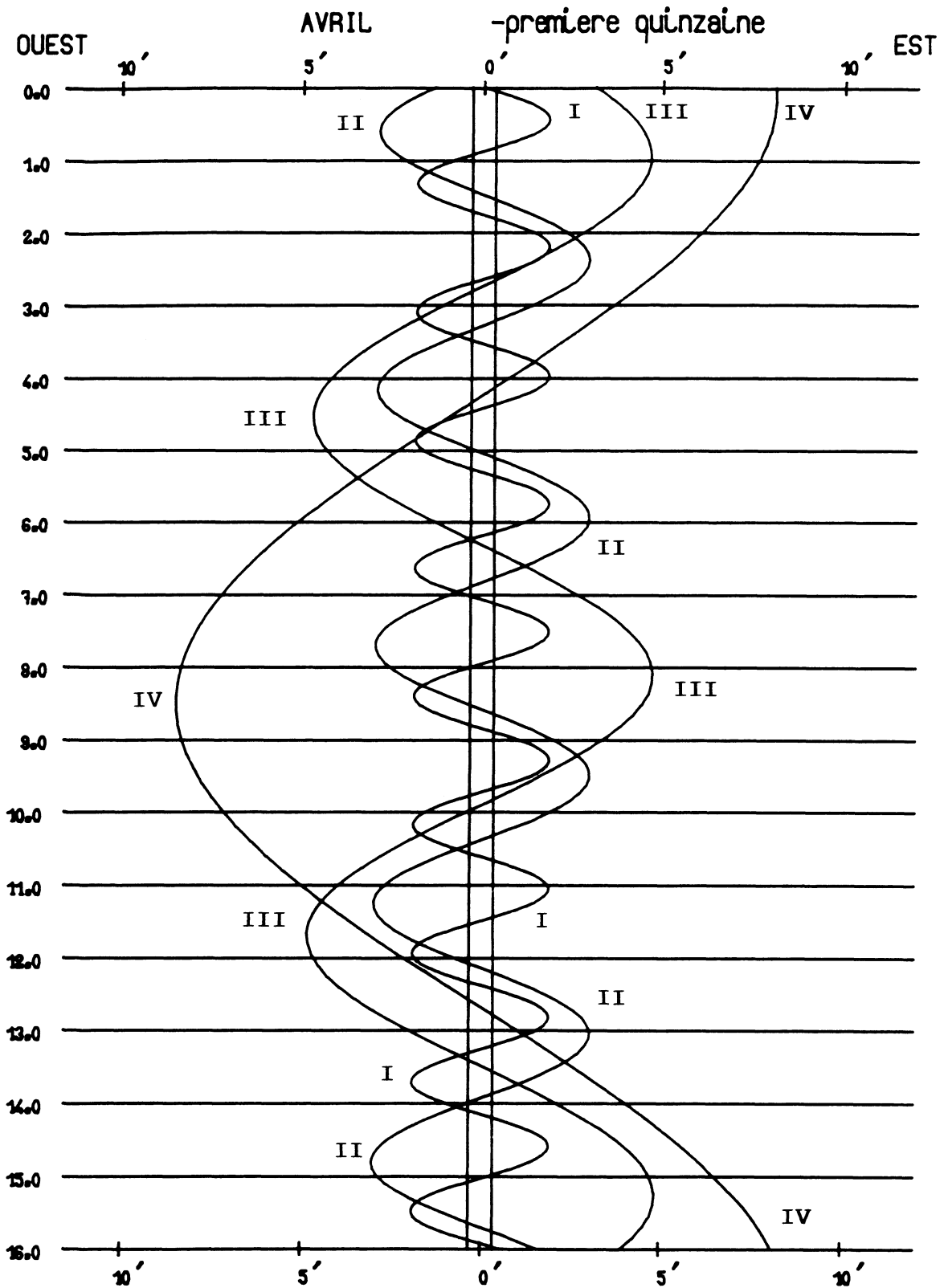

Dans le sens OUEST-EST, les satellites passent au-delà de Jupiter

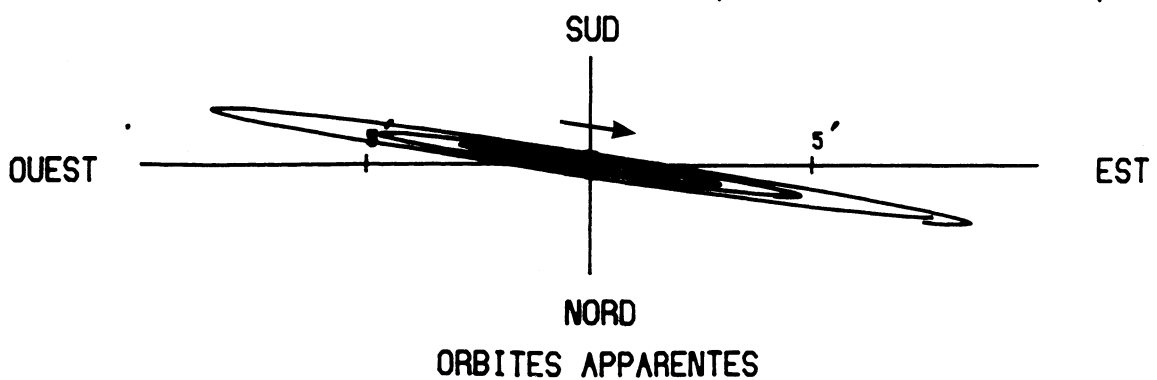

1996 - PHÉNOMÈNES DES SATELLITES GALILÉENS DE JUPITER
(Temps Terrestre)

DEUXIÈME QUINZAINE DE AVRIL																	
jour	h	m	s	SAT.	TYPE	jour	h	m	s	SAT.	TYPE	jour	h	m	s	SAT.	TYPE
16	16	53	39	I	OM.D.EXT	23	43	15	II	PA.D.EXT	26	4	45	8	II	EC.D.PEN	
	16	57	21	I	OM.D.INT	23	47	9	II	PA.D.INT		4	46	41	II	EC.D.EXT	
	18	10	2	I	PA.D.EXT	23	59	2	II	OM.F.INT		4	50	42	II	EC.D.INT	
	18	13	43	I	PA.D.INT							10	5	49	II	OC.F.INT	
	19	2	10	III	OM.D.EXT	21	0	2	59	II	OM.F.EXT	10	9	46	II	OC.F.EXT	
	19	7	53	I	OM.F.INT	2	28	44	II	PA.F.INT	10	33	40	I	EC.D.PEN		
	19	11	36	I	OM.F.EXT	2	32	37	II	PA.F.EXT	10	34	24	I	EC.D.EXT		
	19	12	21	III	OM.D.INT	3	8	46	I	EC.D.PEN	10	38	5	I	EC.D.INT		
	20	24	18	I	PA.F.INT	3	9	30	I	EC.D.EXT	14	2	26	I	OC.F.INT		
	20	27	59	I	PA.F.EXT	3	13	12	I	EC.D.INT	14	6	5	I	OC.F.EXT		
	22	1	34	III	OM.F.INT	6	39	22	I	OC.F.INT							
	22	11	49	III	OM.F.EXT	6	43	2	I	OC.F.EXT							
17	0	12	18	III	PA.D.EXT	22	0	18	45	I	OM.D.EXT	27	7	43	57	I	OM.D.EXT
	0	22	8	III	PA.D.INT	0	22	27	I	OM.D.INT		7	47	39	I	OM.D.INT	
	3	15	44	III	PA.F.INT	1	33	54	I	PA.D.EXT		8	57	15	I	PA.D.EXT	
	3	25	32	III	PA.F.EXT	1	37	35	I	PA.D.INT		9	0	56	I	PA.D.INT	
	7	57	12	II	OM.D.EXT	2	33	7	I	OM.F.INT		9	58	28	I	OM.F.INT	
	8	1	9	II	OM.D.INT	2	36	50	I	OM.F.EXT		10	2	10	I	OM.F.EXT	
	10	28	15	II	PA.D.EXT	3	48	15	I	PA.F.INT		11	11	43	I	PA.F.INT	
	10	32	8	II	PA.D.INT	3	51	56	I	PA.F.EXT		11	15	24	I	PA.F.EXT	
	10	42	9	II	OM.F.INT	15	27	1	II	EC.D.PEN		12	59	35	III	EC.D.PEN	
	10	46	6	II	OM.F.EXT	15	28	34	II	EC.D.EXT		13	3	10	III	EC.D.EXT	
	13	13	40	II	PA.F.INT	15	32	35	II	EC.D.INT		13	13	25	III	EC.D.INT	
	13	17	34	II	PA.F.EXT	20	50	0	II	OC.F.INT		15	58	36	III	EC.F.INT	
	14	12	11	I	EC.D.PEN	20	53	57	II	OC.F.EXT		16	8	51	III	EC.F.EXT	
	14	12	56	I	EC.D.EXT	21	37	3	I	EC.D.PEN		16	12	25	III	EC.F.PEN	
	14	16	37	I	EC.D.INT	21	37	47	I	EC.D.EXT		17	55	29	III	OC.D.EXT	
	17	43	40	I	OC.F.INT	21	41	28	I	EC.D.INT		18	5	11	III	OC.D.INT	
	17	47	20	I	OC.F.EXT	21	41	28	I	EC.D.INT		21	1	51	III	OC.F.INT	
18	11	21	58	I	OM.D.EXT	23	1	7	6	I	OC.F.INT	21	11	33	III	OC.F.EXT	
	11	25	40	I	OM.D.INT	1	10	46	I	OC.F.EXT		23	47	29	II	OM.D.EXT	
	12	38	0	I	PA.D.EXT	18	47	10	I	OM.D.EXT		23	51	26	II	OM.D.INT	
	12	41	41	I	PA.D.INT	18	50	52	I	OM.D.INT	28	2	11	39	II	PA.D.EXT	
	13	36	15	I	OM.F.INT	20	1	46	I	PA.D.EXT		2	15	32	II	PA.D.INT	
	13	39	57	I	OM.F.EXT	20	5	27	I	PA.D.INT		2	32	46	II	OM.F.INT	
	14	52	18	I	PA.F.INT	21	1	36	I	OM.F.INT		2	36	43	II	OM.F.EXT	
	14	55	59	I	PA.F.EXT	21	5	18	I	OM.F.EXT		4	57	15	II	PA.F.INT	
19	2	9	34	II	EC.D.PEN	22	16	10	I	PA.F.INT		5	1	8	II	PA.F.EXT	
	2	11	6	II	EC.D.EXT	22	19	51	I	PA.F.EXT		5	1	58	I	EC.D.PEN	
	2	15	7	II	EC.D.INT	23	0	23	III	OM.D.EXT		5	2	42	I	EC.D.EXT	
	7	34	24	II	OC.F.INT	23	10	30	III	OM.D.INT		5	6	23	I	EC.D.INT	
	7	38	21	II	OC.F.EXT	24	2	0	48	III	OM.F.INT	8	29	59	I	OC.F.INT	
	8	40	28	I	EC.D.PEN	2	11	0	III	OM.F.EXT		8	33	38	I	OC.F.EXT	
	8	41	12	I	EC.D.EXT	4	2	45	III	PA.D.EXT	29	2	12	18	I	OM.D.EXT	
	8	44	54	I	EC.D.INT	4	12	33	III	PA.D.INT		2	16	0	I	OM.D.INT	
	12	11	33	I	OC.F.INT	7	6	54	III	PA.F.INT		3	24	51	I	PA.D.EXT	
	12	15	12	I	OC.F.EXT	7	16	40	III	PA.F.EXT		3	28	32	I	PA.D.INT	
20	5	50	24	I	OM.D.EXT	10	30	46	II	OM.D.EXT		4	26	52	I	OM.F.INT	
	5	54	6	I	OM.D.INT	10	34	42	II	OM.D.INT		4	30	35	I	OM.F.EXT	
	7	6	1	I	PA.D.EXT	12	57	45	II	PA.D.EXT		5	39	22	I	PA.F.INT	
	7	9	43	I	PA.D.INT	13	1	38	II	PA.D.INT		5	43	2	I	PA.F.EXT	
	8	4	44	I	OM.F.INT	13	15	55	II	OM.F.INT		18	2	38	II	EC.D.PEN	
	8	8	26	I	OM.F.EXT	13	19	52	II	OM.F.EXT		18	4	10	II	EC.D.EXT	
	9	2	4	III	EC.D.PEN	15	43	17	II	PA.F.INT		18	8	11	II	EC.D.INT	
	9	5	39	III	EC.D.EXT	15	47	11	II	PA.F.EXT		23	20	18	II	OC.F.INT	
	9	15	58	III	EC.D.INT	16	5	23	I	EC.D.PEN		23	24	15	II	OC.F.EXT	
	9	20	21	I	PA.F.INT	16	6	7	I	EC.D.EXT		23	30	14	I	EC.D.PEN	
	9	24	2	I	PA.F.EXT	16	9	48	I	EC.D.INT		23	30	59	I	EC.D.EXT	
	12	0	6	III	EC.F.INT	19	34	49	I	OC.F.INT		23	34	40	I	EC.D.INT	
	12	10	25	III	EC.F.EXT	19	38	29	I	OC.F.EXT							
	12	14	0	III	EC.F.PEN	25	13	15	30	I	OM.D.EXT	30	2	57	27	I	OC.F.INT
	14	7	55	III	OC.D.EXT	13	19	12	I	OM.D.INT		3	1	6	I	OC.F.EXT	
	14	17	40	III	OC.D.INT	14	29	29	I	PA.D.EXT		20	40	44	I	OM.D.EXT	
	17	13	41	III	OC.F.INT	14	33	10	I	PA.D.INT		20	44	26	I	OM.D.INT	
	17	23	27	III	OC.F.EXT	15	29	58	I	OM.F.INT		21	52	28	I	PA.D.EXT	
	21	14	0	II	OM.D.EXT	15	33	40	I	OM.F.EXT		21	56	9	I	PA.D.INT	
	21	17	57	II	OM.D.INT	16	43	55	I	PA.F.INT		22	55	22	I	OM.F.INT	
						16	47	36	I	PA.F.EXT		22	59	4	I	OM.F.EXT	

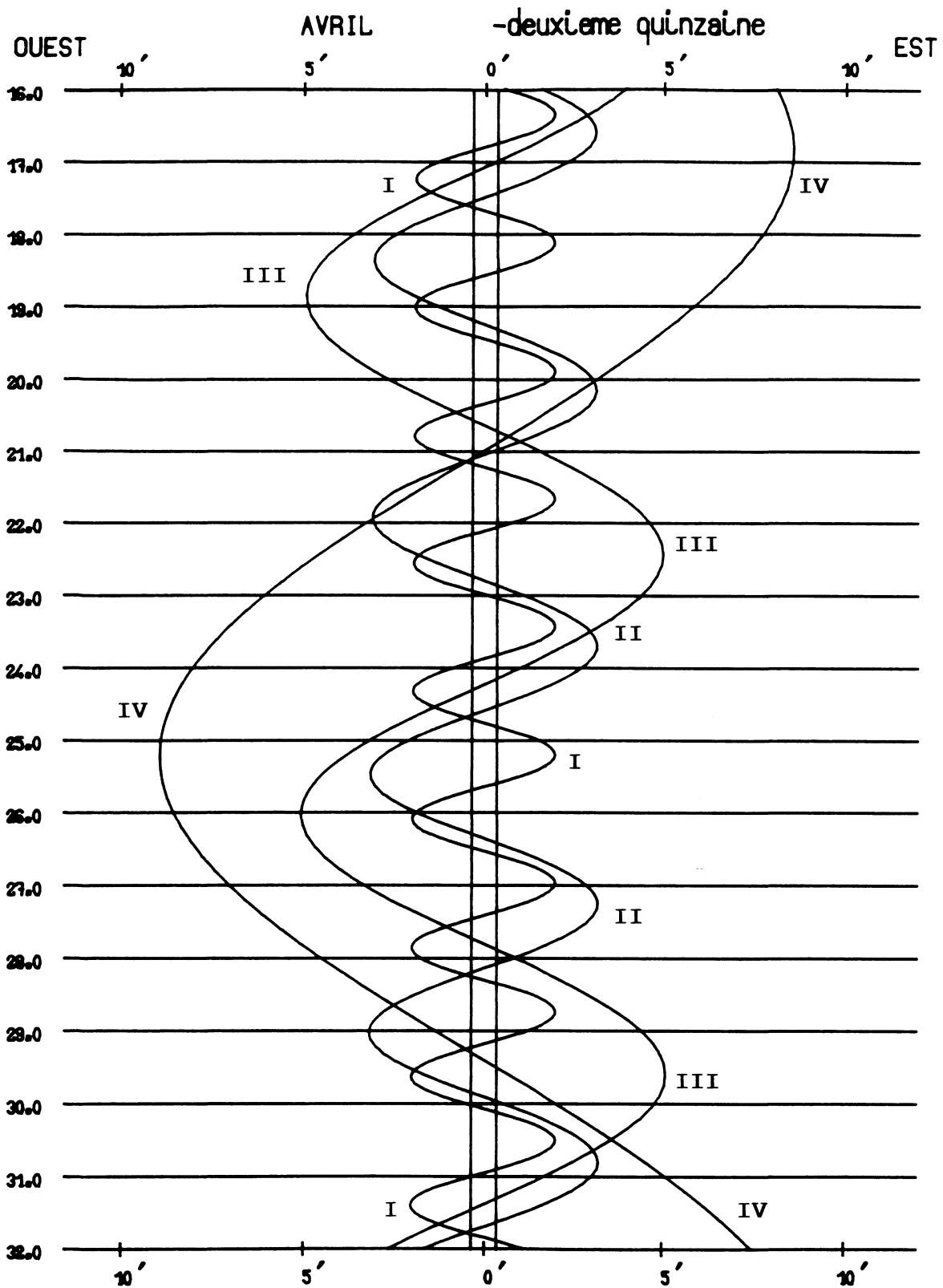

Dans le sens OUEST-EST, les satellites passent au-delà de Jupiter

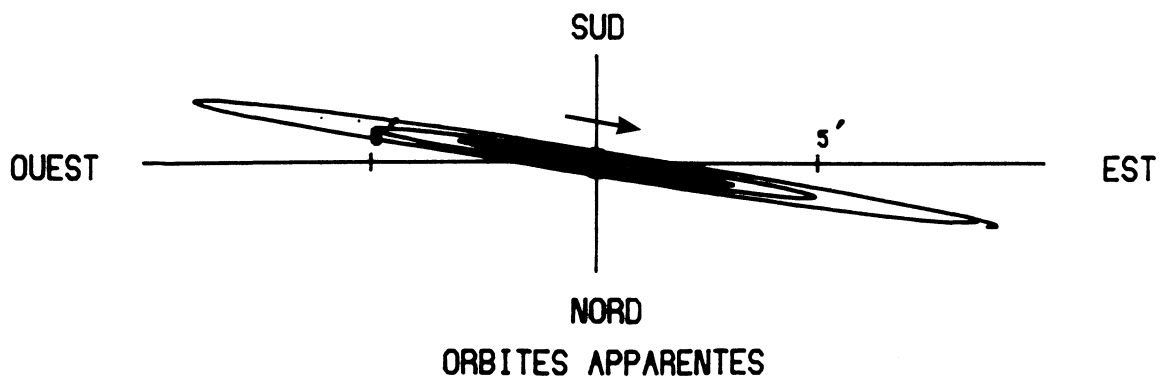

1996 - PHÉNOMÈNES DES SATELLITES GALILÉENS DE JUPITER
(Temps Terrestre)

PREMIÈRE QUINZAINE DE MAI																	
jour	h	m	s	SAT.	TYPE	jour	h	m	s	SAT.	TYPE	jour	h	m	s	SAT.	TYPE
1	0	7	1	I	PA.F.INT							13	49	50	I	OM.F.EXT	
	0	10	42	I	PA.F.EXT							14	51	21	I	PA.F.INT	
	2	59	2	III	OM.D.EXT	6	4	5	53	I	OM.D.EXT	14	55	2	I	PA.F.EXT	
	3	9	7	III	OM.D.INT		4	9	35	I	OM.D.INT	20	55	53	III	EC.D.PEN	
	6	0	31	III	OM.F.INT		5	14	46	I	PA.D.EXT	20	59	26	III	EC.D.EXT	
	6	10	39	III	OM.F.EXT		5	18	27	I	PA.D.INT	21	9	34	III	EC.D.INT	
	7	49	6	III	PA.D.EXT		6	20	41	I	OM.F.INT	23	56	49	III	EC.F.INT	
	7	58	51	III	PA.D.INT		6	24	23	I	OM.F.EXT						
	10	53	52	III	PA.F.INT		7	29	26	I	PA.F.INT						
	11	3	36	III	PA.F.EXT		7	33	7	I	PA.F.EXT	12	0	6	57	III	EC.F.EXT
	13	4	15	II	OM.D.EXT		20	38	24	II	EC.D.PEN	0	10	30	III	EC.F.PEN	
	13	8	11	II	OM.D.INT		20	39	57	II	EC.D.EXT	1	18	18	III	OC.D.EXT	
	15	25	4	II	PA.D.EXT		20	43	57	II	EC.D.INT	1	27	57	III	OC.D.INT	
	15	28	57	II	PA.D.INT	7	1	23	28	I	EC.D.PEN	4	25	30	III	OC.F.INT	
	15	49	40	II	OM.F.INT		1	24	12	I	EC.D.EXT	4	35	10	III	OC.F.EXT	
	15	53	37	II	OM.F.EXT		1	27	53	I	EC.D.INT	4	54	13	II	OM.D.EXT	
	17	58	34	I	EC.D.PEN		1	27	53	I	EC.D.INT	4	58	9	II	OM.D.INT	
	17	59	19	I	EC.D.EXT		1	48	25	II	OC.F.INT	7	1	48	II	PA.D.EXT	
	18	3	0	I	EC.D.INT		1	52	22	II	OC.F.EXT	7	5	41	II	PA.D.INT	
	18	10	45	II	PA.F.INT		4	46	43	I	OC.F.INT	7	40	7	II	OM.F.INT	
	18	14	38	II	PA.F.EXT		4	50	23	I	OC.F.EXT	7	44	3	II	OM.F.EXT	
	21	24	53	I	OC.F.INT		22	34	20	I	OM.D.EXT	8	48	25	I	EC.D.PEN	
	21	28	33	I	OC.F.EXT		22	38	2	I	OM.D.INT	8	49	9	I	EC.D.EXT	
							23	42	8	I	PA.D.EXT	8	52	50	I	EC.D.INT	
							23	45	49	I	PA.D.INT	9	47	44	II	PA.F.INT	
2	15	9	4	I	OM.D.EXT							9	51	36	II	PA.F.EXT	
	15	12	46	I	OM.D.INT	8	0	49	12	I	OM.F.INT	12	8	0	I	OC.F.INT	
	16	19	55	I	PA.D.EXT		0	52	54	I	OM.F.EXT	12	11	39	I	OC.F.EXT	
	16	23	36	I	PA.D.INT		1	56	51	I	PA.F.INT						
	17	23	45	I	OM.F.INT		2	0	31	I	PA.F.EXT	13	5	59	32	I	OM.D.EXT
	17	27	27	I	OM.F.EXT		6	57	0	III	OM.D.EXT	6	6	3	14	I	OM.D.INT
	18	34	31	I	PA.F.INT		7	7	1	III	OM.D.INT	7	3	38	I	PA.D.EXT	
	18	38	11	I	PA.F.EXT		9	59	34	III	OM.F.INT	7	7	19	I	PA.D.INT	
							10	9	39	III	OM.F.EXT	8	14	34	I	OM.F.INT	
3	7	20	51	II	EC.D.PEN		11	30	16	III	PA.D.EXT	8	18	16	I	OM.F.EXT	
	7	22	23	II	EC.D.EXT		11	40	0	III	PA.D.INT	9	18	29	I	PA.F.INT	
	7	26	24	II	EC.D.INT		14	35	36	III	PA.F.INT	9	22	9	I	PA.F.EXT	
	12	26	52	I	EC.D.PEN		14	45	18	III	PA.F.EXT	23	14	21	II	EC.D.PEN	
	12	27	36	I	EC.D.EXT		15	37	36	II	OM.D.EXT	23	15	54	II	EC.D.EXT	
	12	31	17	I	EC.D.INT		15	41	32	II	OM.D.INT	23	19	54	II	EC.D.INT	
	12	35	2	II	OC.F.INT		17	50	8	II	PA.D.EXT						
	12	38	59	II	OC.F.EXT		17	54	1	II	PA.D.INT	14	3	16	43	I	EC.D.PEN
	15	52	14	I	OC.F.INT		18	23	20	II	OM.F.INT	3	17	27	I	EC.D.EXT	
	15	55	54	I	OC.F.EXT		18	27	16	II	OM.F.EXT	3	21	8	I	EC.D.INT	
							19	51	48	I	EC.D.PEN	4	14	22	II	OC.F.INT	
4	9	37	31	I	OM.D.EXT		19	52	32	I	EC.D.EXT	4	18	19	II	OC.F.EXT	
	9	41	13	I	OM.D.INT		19	56	13	I	EC.D.INT	6	34	56	I	OC.F.INT	
	10	47	25	I	PA.D.EXT		20	35	58	II	PA.F.INT	6	38	35	I	OC.F.EXT	
	10	51	6	I	PA.D.INT		20	39	51	II	PA.F.EXT						
	11	52	16	I	OM.F.INT		23	13	54	I	OC.F.INT	15	0	28	0	I	OM.D.EXT
	11	55	58	I	OM.F.EXT		23	17	33	I	OC.F.EXT	0	31	42	I	OM.D.INT	
	13	2	3	I	PA.F.INT							1	30	44	I	PA.D.EXT	
	13	5	44	I	PA.F.EXT	9	17	2	41	I	OM.D.EXT	1	34	25	I	PA.D.INT	
	16	57	19	III	EC.D.PEN		17	6	23	I	OM.D.INT	2	43	6	I	OM.F.INT	
	17	0	53	III	EC.D.EXT		18	9	19	I	PA.D.EXT	2	46	48	I	OM.F.EXT	
	17	11	4	III	EC.D.INT		18	13	0	I	PA.D.INT	3	45	38	I	PA.F.INT	
	19	57	17	III	EC.F.INT		19	17	36	I	OM.F.INT	3	49	18	I	PA.F.EXT	
	20	7	29	III	EC.F.EXT		19	21	18	I	OM.F.EXT	10	54	52	III	OM.D.EXT	
	20	11	2	III	EC.F.PEN		20	24	4	I	PA.F.INT	11	4	51	III	OM.D.INT	
	21	38	44	III	OC.D.EXT		20	27	45	I	PA.F.EXT	13	58	34	III	OM.F.INT	
	21	48	25	III	OC.D.INT							14	8	35	III	OM.F.EXT	
							10	9	56	46	II	EC.D.PEN	15	6	50	III	PA.D.EXT
5	0	45	34	III	OC.F.INT		9	58	18	II	EC.D.EXT	15	16	31	III	PA.D.INT	
	0	55	15	III	OC.F.EXT		10	2	19	II	EC.D.INT	18	10	55	II	OM.D.EXT	
	2	20	54	II	OM.D.EXT		14	20	6	I	EC.D.PEN	18	12	40	III	PA.F.INT	
	2	24	50	II	OM.D.INT		14	20	50	I	EC.D.EXT	18	14	50	II	OM.D.INT	
	4	37	51	II	PA.D.EXT		14	24	31	I	EC.D.INT	18	22	21	III	PA.F.EXT	
	4	41	43	II	PA.D.INT		15	2	7	II	OC.F.INT	20	13	1	II	PA.D.EXT	
	5	6	28	II	OM.F.INT		15	6	4	II	OC.F.EXT	20	16	54	II	PA.D.INT	
	5	10	25	II	OM.F.EXT		17	40	59	I	OC.F.INT	20	56	59	II	OM.F.INT	
	6	55	10	I	EC.D.PEN		17	44	38	I	OC.F.EXT	21	0	54	II	OM.F.EXT	
	6	55	54	I	EC.D.EXT							21	45	4	I	EC.D.PEN	
	6	59	35	I	EC.D.INT							21	45	48	I	EC.D.EXT	
	7	23	36	II	PA.F.INT	11	11	31	9	I	OM.D.EXT	21	49	28	I	EC.D.INT	
	7	27	29	II	PA.F.EXT		11	34	51	I	OM.D.INT	21	49	28	I	EC.D.INT	
	10	19	31	I	OC.F.INT		12	36	33	I	PA.D.EXT	22	59	1	II	PA.F.INT	
	10	23	11	I	OC.F.EXT		12	40	14	I	PA.D.INT	23	2	53	II	PA.F.EXT	
							13	46	8	I	OM.F.INT						

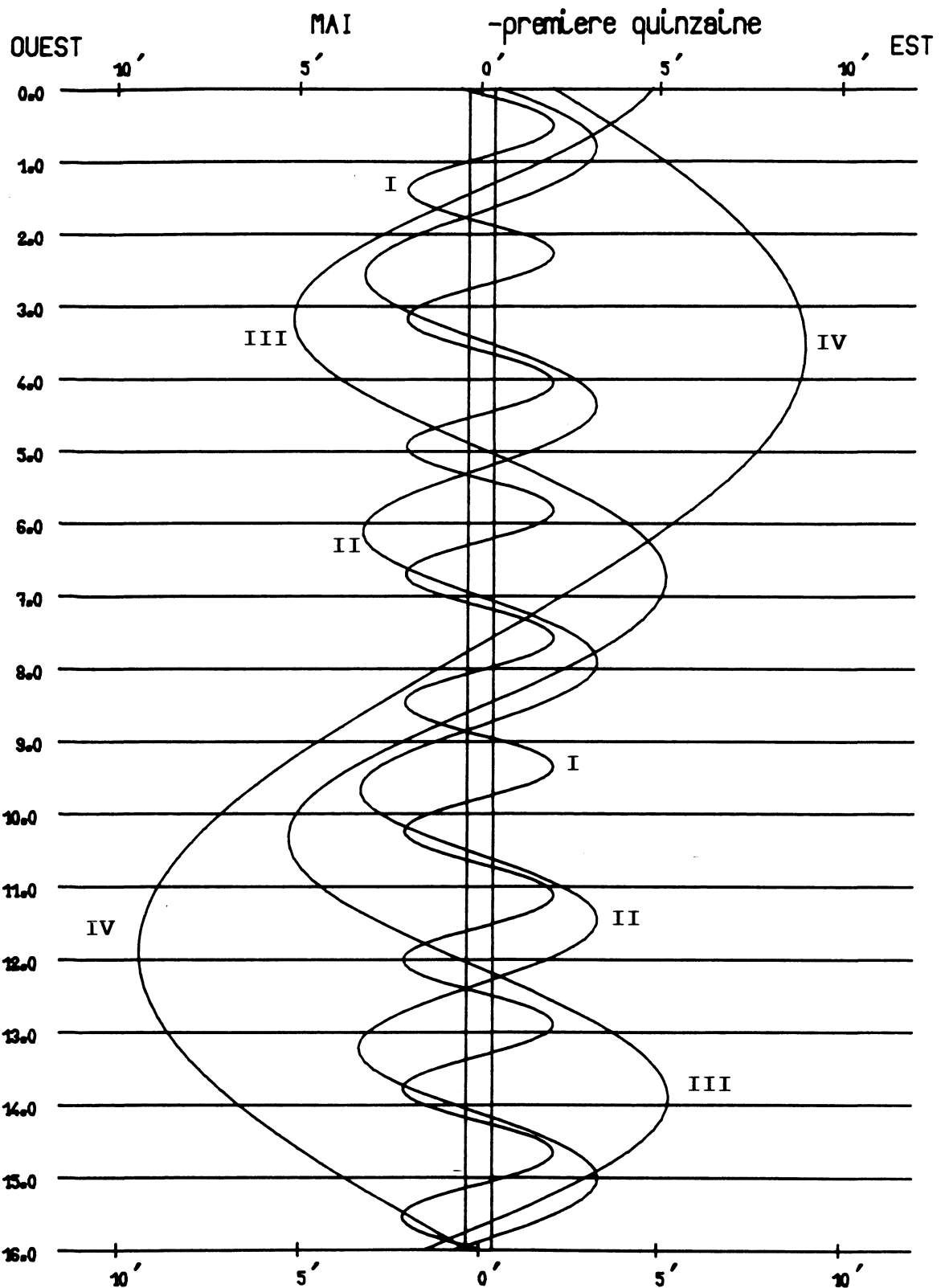

Dans le sens OUEST-EST, les satellites passent au-delà de Jupiter

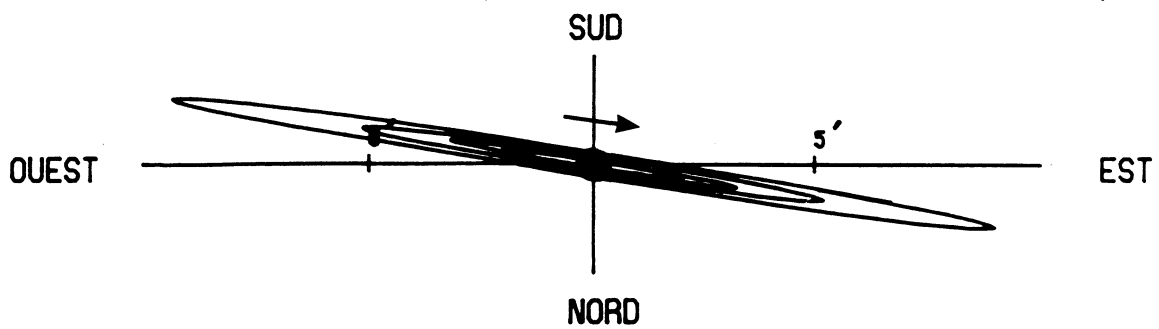

ORBITES APPARENTES

1996 - PHÉNOMÈNES DES SATELLITES GALILÉENS DE JUPITER
(Temps Terrestre)

DEUXIÈME QUINZAINE DE MAI

jour	h	m	s	SAT.	TYPE	jour	h	m	s	SAT.	TYPE	jour	h	m	s	SAT.	TYPE
16	1	1	51	I	OC.F.INT	2	25	26	I	OM.D.INT	12	51	22	II	OM.F.EXT		
	1	5	30	I	OC.F.EXT	3	18	20	I	PA.D.EXT	14	29	39	II	PA.F.INT		
	18	56	22	I	OM.D.EXT	3	22	1	I	PA.D.INT	14	33	31	II	PA.F.EXT		
	19	0	4	I	OM.D.INT	4	37	6	I	OM.F.INT	15	41	53	I	OC.F.INT		
	19	57	40	I	PA.D.EXT	4	40	48	I	OM.F.EXT	15	45	32	I	OC.F.EXT		
	20	1	21	I	PA.D.INT	5	33	24	I	PA.F.INT							
	21	11	32	I	OM.F.INT	5	37	5	I	PA.F.EXT	27	9	47	4	I	OM.D.EXT	
	21	15	14	I	OM.F.EXT	14	52	50	III	OM.D.EXT	9	50	45	I	OM.D.INT		
	22	12	36	I	PA.F.INT	15	2	46	III	OM.D.INT	10	38	21	I	PA.D.EXT		
	22	16	17	I	PA.F.EXT	17	57	42	III	OM.F.INT	10	42	2	I	PA.D.INT		
						18	7	40	III	OM.F.EXT	12	2	37	I	OM.F.INT		
						18	39	7	III	PA.D.EXT	12	6	19	I	OM.F.EXT		
17	12	32	48	II	EC.D.PEN	18	48	48	III	PA.D.INT	12	53	33	I	PA.F.INT		
	12	34	20	II	EC.D.EXT	20	44	12	II	OM.D.EXT	12	57	13	I	PA.F.EXT		
	12	38	20	II	EC.D.INT	20	48	7	II	OM.D.INT							
	16	13	23	I	EC.D.PEN	21	45	24	III	PA.F.INT	28	4	26	45	II	EC.D.PEN	
	16	14	7	I	EC.D.EXT	21	55	4	III	PA.F.EXT	4	28	18	II	EC.D.EXT		
	16	17	47	I	EC.D.INT	22	33	47	II	PA.D.EXT	4	32	17	II	EC.D.INT		
	17	26	57	II	OC.F.INT	22	37	39	II	PA.D.INT	7	3	24	I	EC.D.PEN		
	17	30	54	II	OC.F.EXT	23	30	38	II	OM.F.INT	7	4	8	I	EC.D.EXT		
	19	28	40	I	OC.F.INT	23	34	33	II	OM.F.EXT	7	7	48	I	EC.D.INT		
	19	32	19	I	OC.F.EXT	23	38	23	I	EC.D.PEN	8	59	52	II	OC.F.INT		
						23	39	7	I	EC.D.EXT	9	3	49	II	OC.F.EXT		
18	13	24	51	I	OM.D.EXT	23	42	47	I	EC.D.INT	10	8	20	I	OC.F.INT		
	13	28	33	I	OM.D.INT						10	11	59	I	OC.F.EXT		
	14	24	39	I	PA.D.EXT	23	1	19	57	II	PA.F.INT						
	14	28	20	I	PA.D.INT	1	23	49	II	PA.F.EXT	29	4	15	35	I	OM.D.EXT	
	15	40	5	I	OM.F.INT	2	48	46	I	OC.F.INT	4	19	16	I	OM.D.INT		
	15	43	47	I	OM.F.EXT	2	52	25	I	OC.F.EXT	5	4	58	I	PA.D.EXT		
	16	39	37	I	PA.F.INT	20	50	7	I	OM.D.EXT	5	8	39	I	PA.D.INT		
	16	43	18	I	PA.F.EXT	20	53	49	I	OM.D.INT	6	31	12	I	OM.F.INT		
						21	45	1	I	PA.D.EXT	6	34	54	I	OM.F.EXT		
19	0	54	4	III	EC.D.PEN	21	48	41	I	PA.D.INT	7	20	13	I	PA.F.INT		
	0	57	35	III	EC.D.EXT	23	5	33	I	OM.F.INT	7	23	54	I	PA.F.EXT		
	1	7	39	III	EC.D.INT	23	9	15	I	OM.F.EXT	18	51	6	III	OM.D.EXT		
	3	55	56	III	EC.F.INT						19	0	59	III	OM.D.INT		
	4	6	1	III	EC.F.EXT	24	0	0	7	I	PA.F.INT	21	57	7	III	OM.F.INT	
	4	9	32	III	EC.F.PEN	0	3	48	I	PA.F.EXT	22	7	2	III	OM.F.EXT		
	4	52	52	III	OC.D.EXT	15	9	1	II	EC.D.PEN	22	7	27	III	PA.D.EXT		
	5	2	29	III	OC.D.INT	15	10	33	II	EC.D.EXT	22	17	7	III	PA.D.INT		
	7	27	33	II	OM.D.EXT	15	14	33	II	EC.D.INT	23	17	30	II	OM.D.EXT		
	7	31	28	II	OM.D.INT	18	6	43	I	EC.D.PEN	23	21	24	II	OM.D.INT		
	8	0	20	III	OC.F.INT	18	7	27	I	EC.D.EXT							
	8	9	58	III	OC.F.EXT	18	11	8	I	EC.D.INT	30	0	52	33	II	PA.D.EXT	
	9	23	39	II	PA.D.EXT	19	49	41	II	OC.F.INT	0	56	26	II	PA.D.INT		
	9	27	31	II	PA.D.INT	19	53	38	II	OC.F.EXT	1	14	6	III	PA.F.INT		
	10	13	48	II	OM.F.INT	21	15	22	I	OC.F.INT	1	23	45	III	PA.F.EXT		
	10	17	43	II	OM.F.EXT	21	19	1	I	OC.F.EXT	1	31	46	I	EC.D.PEN		
	10	41	42	I	EC.D.PEN						1	32	30	I	EC.D.EXT		
	10	42	26	I	EC.D.EXT	25	15	18	38	I	OM.D.EXT	1	36	10	I	EC.D.INT	
	10	46	7	I	EC.D.INT	15	22	20	I	OM.D.INT	2	4	18	II	OM.F.INT		
	12	9	44	II	PA.F.INT	16	11	45	I	PA.D.EXT	2	8	13	II	OM.F.EXT		
	12	13	37	II	PA.F.EXT	16	15	26	I	PA.D.INT	3	38	53	II	PA.F.INT		
	13	55	26	I	OC.F.INT	17	34	8	I	OM.F.INT	3	42	45	II	PA.F.EXT		
	13	59	5	I	OC.F.EXT	17	37	50	I	OM.F.EXT	4	34	46	I	OC.F.INT		
						18	26	54	I	PA.F.INT	4	38	25	I	OC.F.EXT		
20	7	53	15	I	OM.D.EXT	18	30	35	I	PA.F.EXT	22	43	59	I	OM.D.EXT		
	7	56	57	I	OM.D.INT						22	47	41	I	OM.D.INT		
	8	51	29	I	PA.D.EXT	26	4	52	48	III	EC.D.PEN	23	31	26	I	PA.D.EXT	
	8	55	10	I	PA.D.INT	4	56	19	III	EC.D.EXT	23	35	7	I	PA.D.INT		
	10	8	33	I	OM.F.INT	5	6	19	III	EC.D.INT							
	10	12	15	I	OM.F.EXT	7	55	36	III	EC.F.INT	31	0	59	40	I	OM.F.INT	
	11	6	30	I	PA.F.INT	8	5	36	III	EC.F.EXT	1	3	22	I	OM.F.EXT		
	11	10	11	I	PA.F.EXT	8	9	7	III	EC.F.PEN	1	46	43	I	PA.F.INT		
						8	23	36	III	OC.D.EXT	1	50	23	I	PA.F.EXT		
21	1	50	27	II	EC.D.PEN	8	33	12	III	OC.D.INT	17	45	22	II	EC.D.PEN		
	1	51	59	II	EC.D.EXT	10	0	50	II	OM.D.EXT	17	46	55	II	EC.D.EXT		
	1	55	59	II	EC.D.INT	10	4	44	II	OM.D.INT	17	50	54	II	EC.D.INT		
	5	10	1	I	EC.D.PEN	11	31	12	III	OC.F.INT	20	0	8	I	EC.D.PEN		
	5	10	45	I	EC.D.EXT	11	40	49	III	OC.F.EXT	20	0	52	I	EC.D.EXT		
	5	14	26	I	EC.D.INT	11	43	23	II	PA.D.EXT	20	4	32	I	EC.D.INT		
	6	38	7	II	OC.F.INT	11	47	16	II	PA.D.INT	22	10	27	II	OC.F.INT		
	6	42	4	II	OC.F.EXT	12	35	4	I	EC.D.PEN	22	14	24	II	OC.F.EXT		
	8	22	7	I	OC.F.INT	12	35	48	I	EC.D.EXT	23	1	8	I	OC.F.INT		
	8	25	46	I	OC.F.EXT	12	39	28	I	EC.D.INT	23	4	47	I	OC.F.EXT		
22	2	21	44	I	OM.D.EXT	12	47	27	II	OM.F.INT							

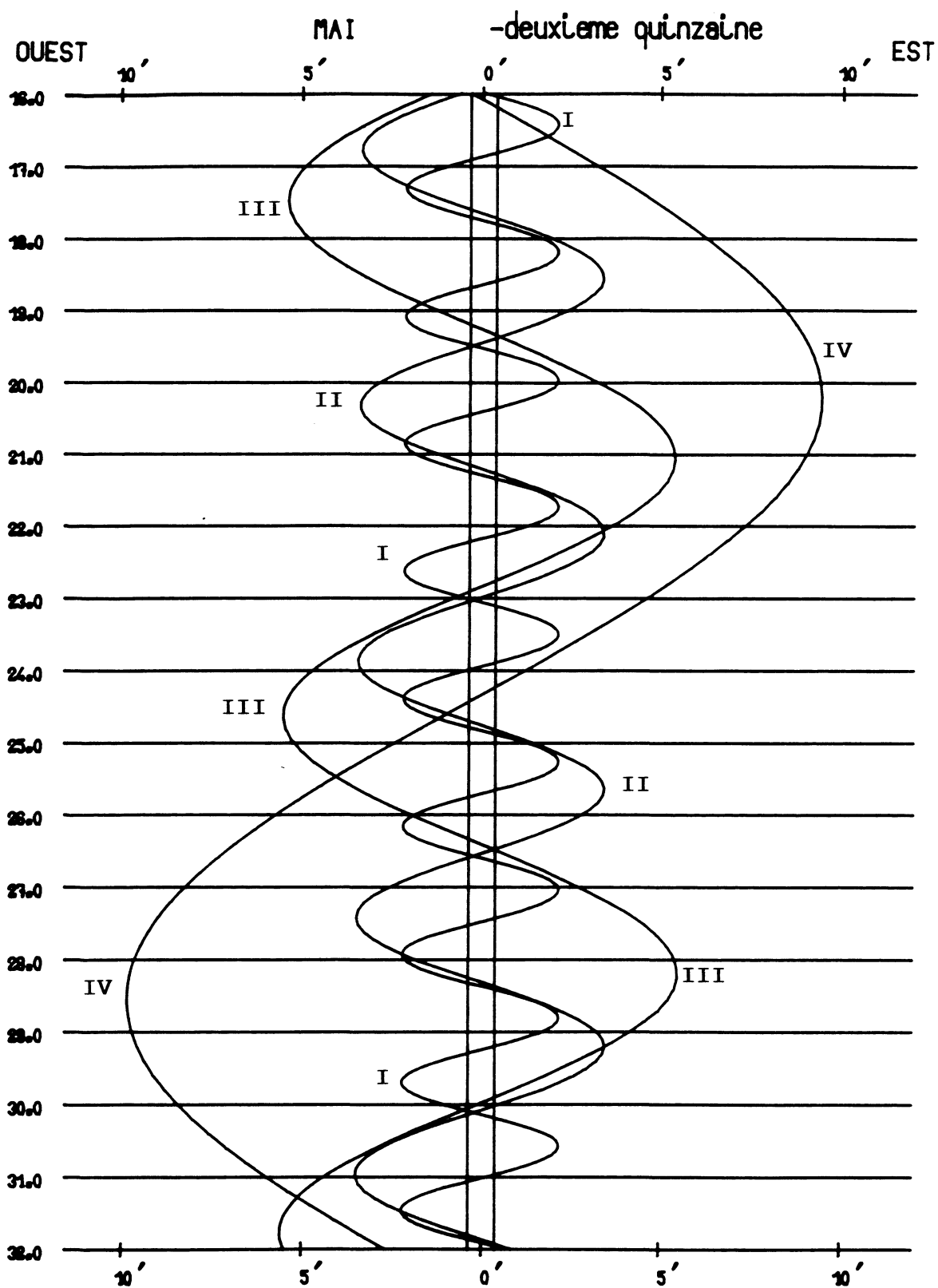

Dans le sens OUEST-EST, les satellites passent au-dela de Jupiter

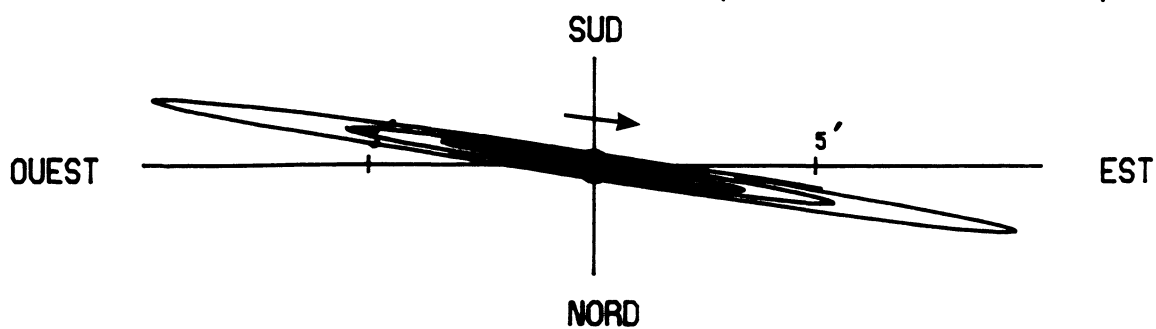

ORBITES APPARENTES

1996 - PHÉNOMÈNES DES SATELLITES GALILÉENS DE JUPITER
(Temps Terrestre)

PREMIÈRE QUINZAINE DE JUIN																	
jour	h	m	s	SAT.	TYPE	jour	h	m	s	SAT.	TYPE	jour	h	m	s	SAT.	TYPE
1	17	12	32	I	OM.D.EXT	3	25	59	I	EC.D.EXT	9	41	20	II	EC.D.EXT		
	17	16	13	I	OM.D.INT		3	29	39	I	EC.D.INT		9	45	19	II	EC.D.INT
	17	57	58	I	PA.D.EXT		4	38	5	II	OM.F.INT		10	50	24	I	EC.D.PEN
	18	1	39	I	PA.D.INT		4	39	53	III	PA.F.INT		10	51	8	I	EC.D.EXT
	19	28	17	I	OM.F.INT		4	41	59	II	OM.F.EXT		10	54	48	I	EC.D.INT
	19	31	58	I	OM.F.EXT		4	49	32	III	PA.F.EXT		13	37	59	II	OC.F.INT
	20	13	17	I	PA.F.INT		5	56	6	II	PA.F.INT		13	38	19	I	OC.F.INT
	20	16	58	I	PA.F.EXT		5	59	58	II	PA.F.EXT		13	41	56	II	OC.F.EXT
							6	19	55	I	OC.F.INT		13	41	58	I	OC.F.EXT
							6	23	34	I	OC.F.EXT						
2	8	50	48	III	EC.D.PEN							12	8	3	37	I	OM.D.EXT
	8	54	18	III	EC.D.EXT								8	7	18	I	OM.D.INT
	9	4	15	III	EC.D.INT								8	35	52	I	PA.D.EXT
	12	34	11	II	OM.D.EXT	7	0	37	58	I	OM.D.EXT		8	39	33	I	PA.D.INT
	12	38	5	II	OM.D.INT		0	41	40	I	OM.D.INT		10	19	43	I	OM.F.INT
	14	1	17	II	PA.D.EXT		1	17	3	I	PA.D.EXT		10	19	43	I	OM.F.INT
	14	5	10	II	PA.D.INT		1	20	44	I	PA.D.INT		10	23	25	I	OM.F.EXT
	14	28	29	I	EC.D.PEN		2	53	54	I	EC.D.EXT		10	51	23	I	PA.F.INT
	14	29	14	I	EC.D.EXT		2	57	36	I	OM.F.EXT		10	55	4	I	PA.F.EXT
	14	32	54	I	EC.D.INT		3	32	28	I	PA.F.INT						
	14	57	20	III	OC.F.INT		3	36	9	I	PA.F.EXT						
	15	6	56	III	OC.F.EXT		20	21	53	II	EC.D.PEN	13	2	49	11	III	OM.D.EXT
	15	21	11	II	OM.F.INT		20	23	25	II	EC.D.EXT		2	58	59	III	OM.D.INT
	15	25	6	II	OM.F.EXT		20	27	24	II	EC.D.INT		4	24	21	II	OM.D.EXT
	16	47	42	II	PA.F.INT		20	27	24	II	EC.D.INT		4	28	14	II	OM.D.INT
	16	51	34	II	PA.F.EXT		21	53	38	I	EC.D.PEN		4	54	36	III	PA.D.EXT
	17	27	26	I	OC.F.INT		21	54	22	I	EC.D.EXT		5	4	15	III	PA.D.INT
	17	31	5	I	OC.F.EXT		21	58	2	I	EC.D.INT		5	18	49	I	EC.D.PEN
													5	19	33	I	EC.D.EXT
3	11	40	59	I	OM.D.EXT	8	0	29	28	II	OC.F.INT		5	23	13	I	EC.D.INT
	11	44	41	I	OM.D.INT		0	33	24	II	OC.F.EXT		5	25	9	II	PA.D.EXT
	12	24	21	I	PA.D.EXT		0	46	7	I	OC.F.INT		5	29	1	II	PA.D.INT
	12	28	2	I	PA.D.INT		0	49	46	I	OC.F.EXT		5	57	28	III	OM.F.INT
	13	56	48	I	OM.F.INT		19	6	33	I	OM.D.EXT		6	7	17	III	OM.F.EXT
	14	0	29	I	OM.F.EXT		19	10	14	I	OM.D.INT		7	11	54	II	OM.F.INT
	14	39	42	I	PA.F.INT		19	43	23	I	PA.D.EXT		7	15	48	II	OM.F.EXT
	14	43	23	I	PA.F.EXT		19	47	4	I	PA.D.INT		8	1	44	III	PA.F.INT
							21	22	32	I	OM.F.INT		8	4	24	I	OC.F.INT
							21	26	14	I	OM.F.EXT		8	8	3	I	OC.F.EXT
							21	58	51	I	PA.F.INT		8	11	23	III	PA.F.EXT
							22	2	32	I	PA.F.EXT		8	11	44	II	PA.F.INT
4	7	3	11	II	EC.D.PEN	9	12	48	44	III	EC.D.PEN		8	15	36	II	PA.F.EXT
	7	4	43	II	EC.D.EXT		12	52	12	III	EC.D.EXT						
	7	8	42	II	EC.D.INT		13	2	5	III	EC.D.INT	14	2	32	5	I	OM.D.EXT
	8	56	51	I	EC.D.PEN		13	2	5	III	EC.D.INT		2	35	47	I	OM.D.INT
	8	57	35	I	EC.D.EXT		15	7	35	II	OM.D.EXT		3	1	58	I	PA.D.EXT
	9	1	15	I	EC.D.INT		15	11	29	II	OM.D.INT		3	5	39	I	PA.D.INT
	11	19	44	II	OC.F.INT		16	17	32	II	PA.D.EXT		4	48	15	I	OM.F.INT
	11	23	40	II	OC.F.EXT		16	21	24	II	PA.D.INT		4	51	56	I	OM.F.EXT
	11	53	42	I	OC.F.INT		16	22	1	I	EC.D.PEN		5	17	31	I	PA.F.INT
	11	57	21	I	OC.F.EXT		16	22	45	I	EC.D.EXT		5	21	12	I	PA.F.EXT
							16	26	25	I	EC.D.INT		22	58	35	II	EC.D.PEN
5	6	9	32	I	OM.D.EXT		17	54	58	II	OM.F.INT		23	0	7	II	EC.D.EXT
	6	13	13	I	OM.D.INT		17	58	52	II	OM.F.EXT		23	4	6	II	EC.D.INT
	6	50	47	I	PA.D.EXT		18	19	48	III	OC.F.INT		23	47	14	I	EC.D.PEN
	6	54	28	I	PA.D.INT		18	29	23	III	OC.F.EXT		23	47	58	I	EC.D.EXT
	8	25	24	I	OM.F.INT		19	4	5	II	PA.F.INT		23	51	38	I	EC.D.INT
	8	29	6	I	OM.F.EXT		19	7	57	II	PA.F.EXT						
	9	6	10	I	PA.F.INT		19	12	14	I	OC.F.INT						
	9	9	51	I	PA.F.EXT		19	15	53	I	OC.F.EXT						
	22	50	21	III	OM.D.EXT							15	2	30	26	I	OC.F.INT
	23	0	12	III	OM.D.INT								2	34	5	I	OC.F.EXT
													2	47	2	II	OC.F.INT
6	1	32	57	III	PA.D.EXT	10	13	35	2	I	OM.D.EXT		2	50	58	II	OC.F.EXT
	1	42	36	III	PA.D.INT		13	38	43	I	OM.D.INT		21	0	42	I	OM.D.EXT
	1	50	53	II	OM.D.EXT		14	9	36	I	PA.D.EXT		21	4	23	I	OM.D.INT
	1	54	47	II	OM.D.INT		14	13	17	I	PA.D.INT		21	28	10	I	PA.D.EXT
	1	57	32	III	OM.F.INT		15	51	5	I	OM.F.INT		21	31	51	I	PA.D.INT
	2	7	24	III	OM.F.EXT		15	54	46	I	OM.F.EXT		23	16	54	I	OM.F.INT
	3	9	37	II	PA.D.EXT		16	25	6	I	PA.F.INT		23	20	35	I	OM.F.EXT
	3	13	29	II	PA.D.INT		16	28	46	I	PA.F.EXT		23	43	45	I	PA.F.INT
	3	25	15	I	EC.D.PEN								23	47	25	I	PA.F.EXT
						11	9	39	48	II	EC.D.PEN						

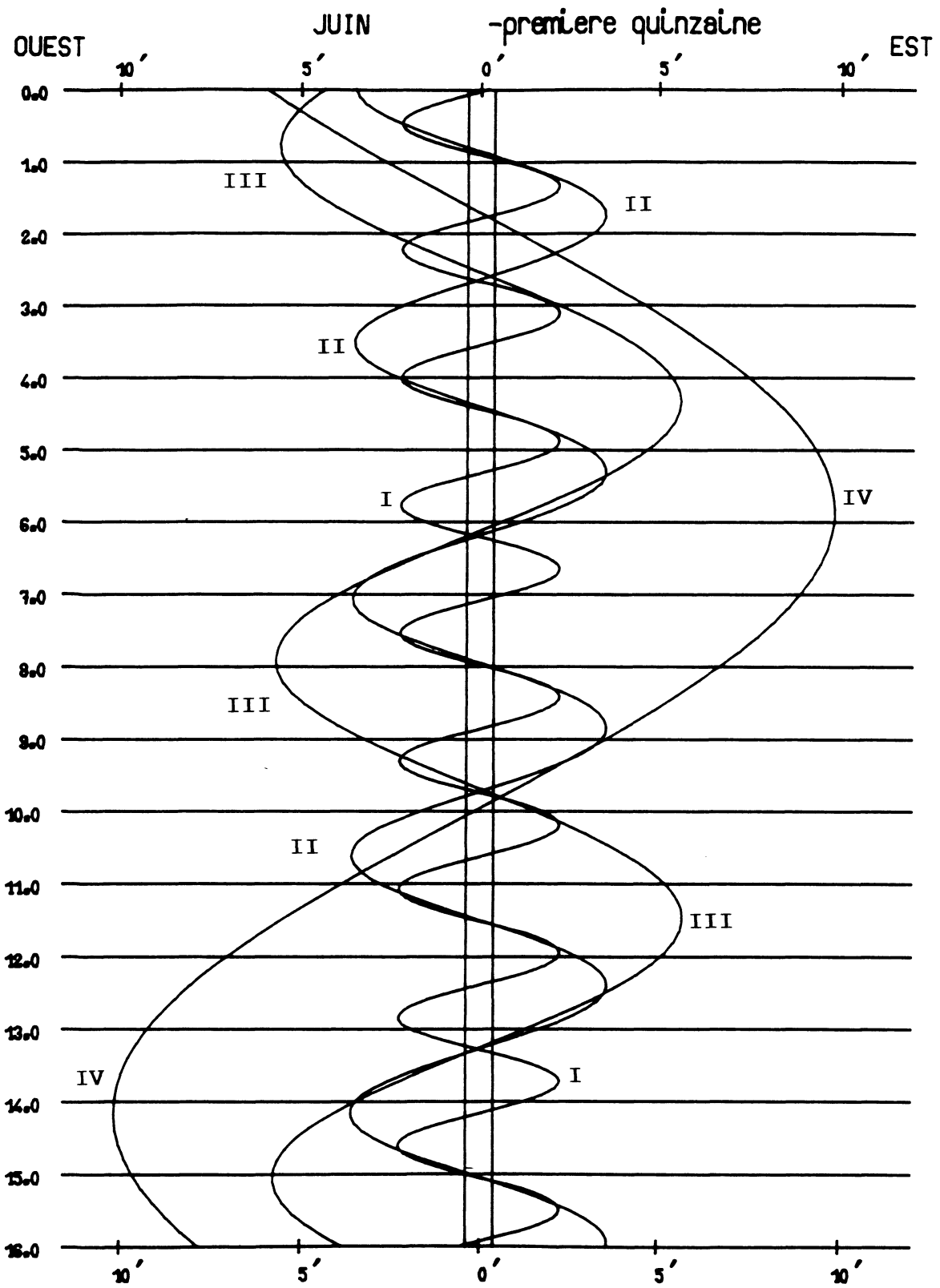

Dans le sens OUEST-EST, les satellites passent au-delà de Jupiter

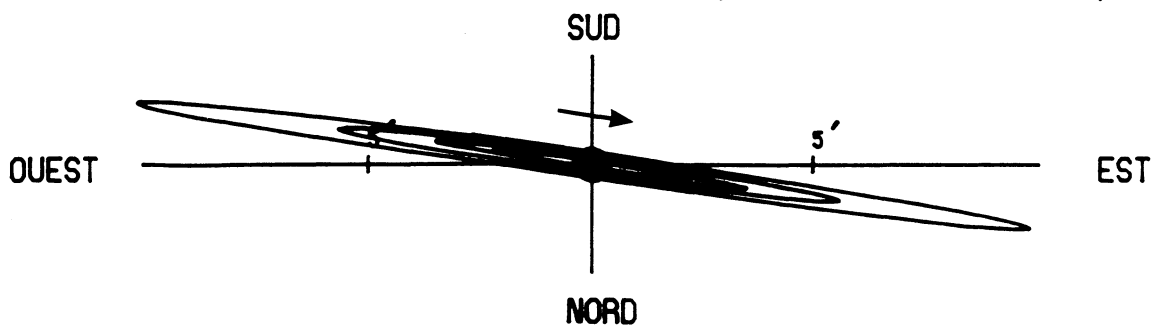

ORBITES APPARENTES

1996 - PHÉNOMÈNES DES SATELLITES GALILÉENS DE JUPITER
(Temps Terrestre)

DEUXIÈME QUINZAINE DE JUIN																		
jour	h	m	s	SAT.	TYPE	jour	h	m	s	SAT.	TYPE	jour	h	m	s	SAT.	TYPE	
16	16	46	52	III	EC.D.PEN													
	16	50	20	III	EC.D.EXT							26	11	52	15	I	OM.D.EXT	
	17	0	10	III	EC.D.INT								11	55	56	I	OM.D.INT	
	17	41	7	II	OM.D.EXT	21	4	26	22	I	OM.D.EXT		12	4	33	I	PA.D.EXT	
	17	45	0	II	OM.D.INT		4	30	3	I	OM.D.INT		12	8	14	I	PA.D.INT	
	18	15	39	I	EC.D.PEN		4	46	23	I	PA.D.EXT		14	8	42	I	OM.F.INT	
	18	16	23	I	EC.D.EXT		4	50	4	I	PA.D.INT		14	12	23	I	OM.F.EXT	
	18	20	2	I	EC.D.INT		6	42	42	I	OM.F.INT		14	20	14	I	PA.F.INT	
	18	32	26	II	PA.D.EXT		6	46	24	I	OM.F.EXT		14	23	55	I	PA.F.EXT	
	18	36	18	II	PA.D.INT		7	2	2	I	PA.F.INT							
	20	28	51	II	OM.F.INT		7	5	42	I	PA.F.EXT							
	20	32	45	II	OM.F.EXT							27	9	6	18	I	EC.D.PEN	
	20	56	25	I	OC.F.INT	22	1	35	23	II	EC.D.PEN		9	7	2	I	EC.D.EXT	
	21	0	4	I	OC.F.EXT		1	36	56	II	EC.D.EXT		9	10	42	I	EC.D.INT	
	21	19	5	II	PA.F.INT		1	40	54	II	EC.D.INT		9	31	43	II	OM.D.EXT	
	21	22	57	II	PA.F.EXT		1	40	57	I	EC.D.PEN		9	35	36	II	OM.D.INT	
	21	39	32	III	OC.F.INT		1	41	41	I	EC.D.EXT		9	53	8	II	PA.D.EXT	
	21	49	7	III	OC.F.EXT		1	45	21	I	EC.D.INT		9	57	0	II	PA.D.INT	
							4	14	16	I	OC.F.INT		10	47	24	III	OM.D.EXT	
17	15	29	14	I	OM.D.EXT		4	17	55	I	OC.F.EXT		10	57	6	III	OM.D.INT	
	15	32	55	I	OM.D.INT		5	3	26	II	OC.F.INT		11	31	8	III	PA.D.EXT	
	15	54	15	I	PA.D.EXT		5	7	23	II	OC.F.EXT		11	31	57	I	OC.F.INT	
	15	57	56	I	PA.D.INT		22	55	1	I	OM.D.EXT		11	35	36	I	OC.F.EXT	
	17	45	28	I	OM.F.INT		22	58	42	I	OM.D.INT		11	40	47	III	PA.D.INT	
	17	49	10	I	OM.F.EXT		23	12	29	I	PA.D.EXT		12	19	56	II	OM.F.INT	
	18	9	51	I	PA.F.INT		23	16	10	I	PA.D.INT		12	23	49	II	OM.F.EXT	
	18	13	31	I	PA.F.EXT	23	1	11	23	I	OM.F.INT		12	39	51	II	PA.F.INT	
18	12	16	32	II	EC.D.PEN		1	15	5	I	OM.F.EXT		12	43	44	II	PA.F.EXT	
	12	18	4	II	EC.D.EXT		1	28	9	I	PA.F.INT		13	57	42	III	OM.F.INT	
	12	22	2	II	EC.D.INT		1	31	49	I	PA.F.EXT		14	7	25	III	OM.F.EXT	
	12	44	3	I	EC.D.PEN		20	9	23	I	EC.D.PEN		14	38	24	III	PA.F.INT	
	12	44	47	I	EC.D.EXT		20	10	7	I	EC.D.EXT		14	48	3	III	PA.F.EXT	
	12	48	27	I	EC.D.INT		20	13	47	I	EC.D.INT							
	15	22	23	I	OC.F.INT		20	14	49	II	OM.D.EXT	28	6	20	48	I	OM.D.EXT	
	15	26	2	I	OC.F.EXT		20	18	42	II	OM.D.INT		6	24	29	I	OM.D.INT	
	15	54	54	II	OC.F.INT		20	18	42	II	OM.D.EXT		6	30	30	I	PA.D.EXT	
	15	58	51	II	OC.F.EXT		20	45	18	III	EC.D.PEN		6	34	11	I	PA.D.INT	
19	9	57	51	I	OM.D.EXT		20	46	24	II	PA.D.EXT		8	37	17	I	OM.F.INT	
	10	1	33	I	OM.D.INT		20	48	45	III	EC.D.EXT		8	40	58	I	OM.F.EXT	
	10	20	23	I	PA.D.EXT		20	50	16	II	PA.D.INT		8	46	11	I	PA.F.INT	
	10	24	4	I	PA.D.INT		20	58	32	III	EC.D.INT		8	49	52	I	PA.F.EXT	
	12	14	9	I	OM.F.INT		22	40	10	I	OC.F.INT							
	12	17	50	I	OM.F.EXT		22	43	49	I	OC.F.EXT		29	3	34	47	I	EC.D.PEN
	12	36	1	I	PA.F.INT		23	2	53	II	OM.F.INT		3	35	31	I	EC.D.EXT	
	12	39	41	I	PA.F.EXT		23	6	47	II	OM.F.EXT		3	39	11	I	EC.D.INT	
							23	33	7	II	PA.F.INT		4	12	22	II	EC.D.PEN	
							23	36	59	II	PA.F.EXT		4	13	54	II	EC.D.EXT	
20	6	48	34	III	OM.D.EXT								4	17	52	II	EC.D.INT	
	6	57	58	II	OM.D.EXT	24	0	57	16	III	OC.F.INT		5	57	51	I	OC.F.INT	
	6	58	18	III	OM.D.INT		1	6	51	III	OC.F.EXT		6	1	30	I	OC.F.EXT	
	7	1	51	II	OM.D.INT		17	23	35	I	OM.D.EXT		7	19	11	II	OC.F.INT	
	7	12	30	I	EC.D.PEN		17	27	16	I	OM.D.INT		7	23	8	II	OC.F.EXT	
	7	13	14	I	EC.D.EXT		17	38	29	I	PA.D.EXT							
	7	16	54	I	EC.D.INT		17	42	10	I	PA.D.INT		30	0	49	30	I	OM.D.EXT
	7	39	32	II	PA.D.EXT		19	39	59	I	OM.F.INT		0	53	11	I	OM.D.INT	
	7	43	24	II	PA.D.INT		19	43	41	I	OM.F.EXT		0	56	34	I	PA.D.EXT	
	8	14	4	III	PA.D.EXT		19	54	9	I	PA.F.INT		1	0	14	I	PA.D.INT	
	8	23	42	III	PA.D.INT		19	57	50	I	PA.F.EXT		3	6	0	I	OM.F.INT	
	9	45	52	II	OM.F.INT								3	9	41	I	OM.F.EXT	
	9	48	20	I	OC.F.INT	25	14	37	50	I	EC.D.PEN		3	12	15	I	PA.F.INT	
	9	49	46	II	OM.F.EXT		14	38	34	I	EC.D.EXT		3	15	56	I	PA.F.EXT	
	9	51	59	I	OC.F.EXT		14	42	13	I	EC.D.INT		22	3	15	I	EC.D.PEN	
	9	57	53	III	OM.F.INT		14	53	24	II	EC.D.PEN		22	3	59	I	EC.D.EXT	
	10	7	38	III	OM.F.EXT		14	54	57	II	EC.D.EXT		22	7	39	I	EC.D.INT	
	10	26	13	II	PA.F.INT		14	58	55	II	EC.D.INT		22	48	40	II	OM.D.EXT	
	10	30	5	II	PA.F.EXT		17	6	3	I	OC.F.INT		22	52	33	II	OM.D.INT	
	11	21	17	III	PA.F.INT		17	9	42	I	OC.F.EXT		22	59	47	II	PA.D.EXT	
							18	10	55	II	OC.F.INT		23	3	39	II	PA.D.INT	
							18	14	52	II	OC.F.EXT							

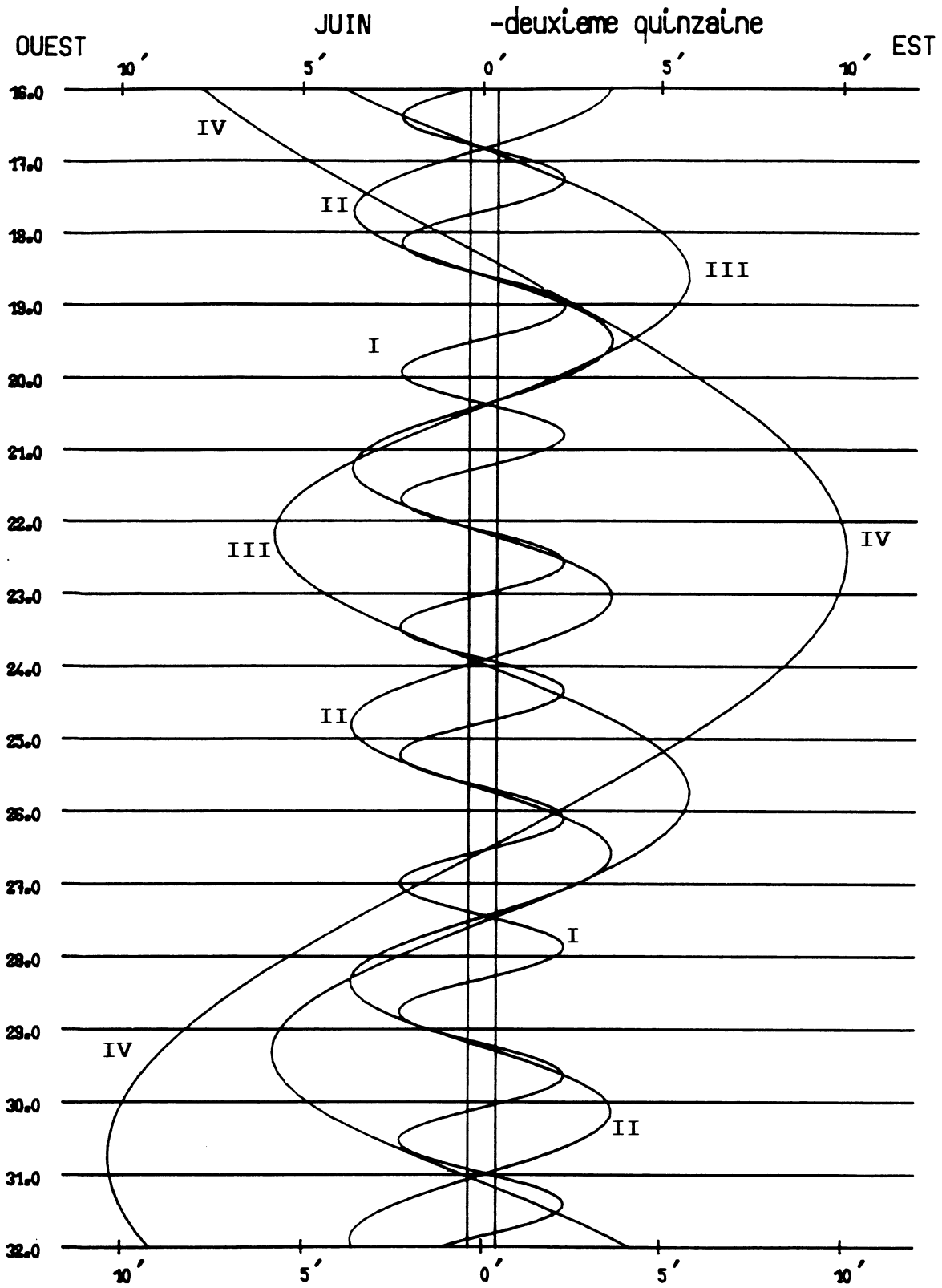

Dans le sens OUEST-EST, les satellites passent au-delà de Jupiter

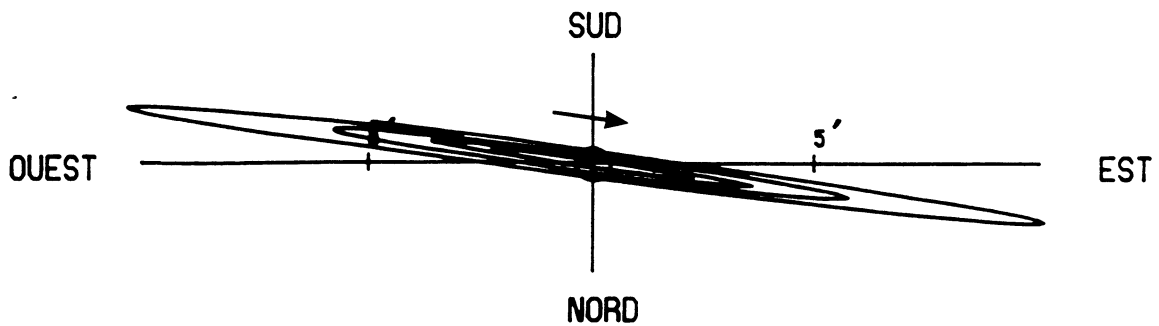

ORBITES APPARENTES

1996 - PHÉNOMÈNES DES SATELLITES GALILÉENS DE JUPITER
(Temps Terrestre)

PREMIÈRE QUINZAINE DE JUILLET																			
jour	h	m	s	SAT.	TYPE	jour	h	m	s	SAT.	TYPE	jour	h	m	s	SAT.	TYPE		
1	0	23	43	I	OC.F.INT	6	5	26	34	I	OC.D.EXT	14	23	44	II	PA.D.INT			
	0	27	22	I	OC.F.EXT		14	39	50	II	OM.D.EXT								
	0	44	40	III	EC.D.PEN		5	30	13	I	OC.D.INT		14	43	43	II	OM.D.INT		
	0	48	6	III	EC.D.EXT		6	44	46	II	OC.D.EXT		15	9	17	I	EC.F.INT		
	0	57	50	III	EC.D.INT		6	48	42	II	OC.D.INT		15	12	56	I	EC.F.EXT		
	1	37	2	II	OM.F.INT		7	43	41	I	EC.F.INT		15	13	40	I	EC.F.PEN		
	1	40	55	II	OM.F.EXT		7	47	20	I	EC.F.EXT		17	6	32	II	PA.F.INT		
	1	46	31	II	PA.F.INT		7	48	4	I	EC.F.PEN		17	10	25	II	PA.F.EXT		
	1	50	24	II	PA.F.EXT		9	39	37	II	EC.F.INT		17	28	33	II	OM.F.INT		
	4	14	31	III	OC.F.INT		9	43	34	II	EC.F.EXT		17	32	25	II	OM.F.EXT		
	4	24	6	III	OC.F.EXT		9	45	6	II	EC.F.PEN		18	3	34	III	PA.D.EXT		
	19	18	6	I	OM.D.EXT								18	13	13	III	PA.D.INT		
	19	21	47	I	OM.D.INT		7	2	40	36	I		PA.D.EXT	18	45	28	III	OM.D.EXT	
	19	22	32	I	PA.D.EXT			2	44	9	I		OM.D.EXT	18	55	4	III	OM.D.INT	
	19	26	13	I	PA.D.INT			2	44	17	I		PA.D.INT	21	10	49	III	PA.F.INT	
	21	34	38	I	OM.F.INT			2	47	50	I		OM.D.INT	21	20	28	III	PA.F.EXT	
	21	38	13	I	PA.F.INT			4	56	17	I		PA.F.INT	21	57	34	III	OM.F.INT	
	21	38	19	I	OM.F.EXT			4	59	58	I		PA.F.EXT	22	7	10	III	OM.F.EXT	
	21	41	54	I	PA.F.EXT			5	0	43	I		OM.F.INT						
								5	4	24	I		OM.F.EXT	12	9	58	44	I	PA.D.EXT
								23	52	27	I		OC.D.EXT		10	2	24	I	PA.D.INT
					23	56		6	I	OC.D.INT	10	10	10		I	OM.D.EXT			
										10	13	51	I		OM.D.INT				
					8	1	13	7	II	PA.D.EXT	12	14	22		I	PA.F.INT			
						1	17	0	II	PA.D.INT	12	18	3		I	PA.F.EXT			
						1	22	46	II	OM.D.EXT	12	26	46		I	OM.F.INT			
						1	26	39	II	OM.D.INT	12	30	27		I	OM.F.EXT			
						2	12	12	I	EC.F.INT									
						2	15	51	I	EC.F.EXT	13	7	10		16	I	OC.D.EXT		
						2	16	35	I	EC.F.PEN		7	13	55	I	OC.D.INT			
						3	59	50	II	PA.F.INT		9	0	31	II	OC.D.EXT			
						4	3	42	II	PA.F.EXT		9	4	28	II	OC.D.INT			
						4	11	23	II	OM.F.INT		9	37	52	I	EC.F.INT			
					4	15	16	II	OM.F.EXT	9		41	31	I	EC.F.EXT				
					4	23	13	III	OC.D.EXT	9		42	15	I	EC.F.PEN				
					4	32	48	III	OC.D.INT	12		16	59	II	EC.F.INT				
					7	52	1	III	EC.F.INT	12		20	56	II	EC.F.EXT				
					8	1	42	III	EC.F.EXT	12		22	27	II	EC.F.PEN				
					8	5	7	III	EC.F.PEN										
					21	6	36	I	PA.D.EXT	14	4	24	53	I	PA.D.EXT				
					21	10	17	I	PA.D.INT		4	28	34	I	PA.D.INT				
					21	12	47	I	OM.D.EXT		4	38	55	I	OM.D.EXT				
					21	16	28	I	OM.D.INT		4	42	36	I	OM.D.INT				
					23	22	16	I	PA.F.INT		6	40	30	I	PA.F.INT				
					23	25	57	I	PA.F.EXT		6	44	11	I	PA.F.EXT				
					23	29	23	I	OM.F.INT		6	55	31	I	OM.F.INT				
					23	33	4	I	OM.F.EXT		6	59	12	I	OM.F.EXT				
					9	18	18	21	I		OC.D.EXT	15	1	36	13	I	OC.D.EXT		
						18	22	0	I		OC.D.INT		1	39	53	I	OC.D.INT		
						19	52	8	II	OC.D.EXT	3		26	48	II	PA.D.EXT			
						19	56	4	II	OC.D.INT	3		30	40	II	PA.D.INT			
						20	40	44	I	EC.F.INT	3		57	0	II	OM.D.EXT			
						20	44	23	I	EC.F.EXT	4		0	52	II	OM.D.INT			
						20	45	7	I	EC.F.PEN	4		6	25	I	EC.F.INT			
						22	57	51	II	EC.F.INT	4		10	4	I	EC.F.EXT			
						23	1	48	II	EC.F.EXT	4		10	49	I	EC.F.PEN			
						23	3	20	II	EC.F.PEN	6		13	27	II	PA.F.INT			
					10	15	32	43	I	PA.D.EXT	6	17	20	II	PA.F.EXT				
						15	36	24	I	PA.D.INT	6	45	49	II	OM.F.INT				
						15	41	32	I	OM.D.EXT	6	49	41	II	OM.F.EXT				
						15	45	13	I	OM.D.INT	7	40	38	III	OC.D.EXT				
						17	48	22	I	PA.F.INT	7	50	13	III	OC.D.INT				
						17	52	3	I	PA.F.EXT	11	52	31	III	EC.F.INT				
						17	58	8	I	OM.F.INT	12	2	9	III	EC.F.EXT				
						18	1	49	I	OM.F.EXT	12	5	33	III	EC.F.PEN				
						11	12	44	17	I	OC.D.EXT	22	50	58	I	PA.D.EXT			
							12	47	56	I	OC.D.INT	22	54	39	I	PA.D.INT			
					14		19	52	II	PA.D.EXT	23	7	36	I	OM.D.EXT				
											23	11	17	I	OM.D.INT				
5	8	14	32	I	PA.D.EXT														
	8	15	25	I	OM.D.EXT														
	8	18	13	I	PA.D.INT														
	8	19	6	I	OM.D.INT														
	10	30	13	I	PA.F.INT														
	10	31	59	I	OM.F.INT														

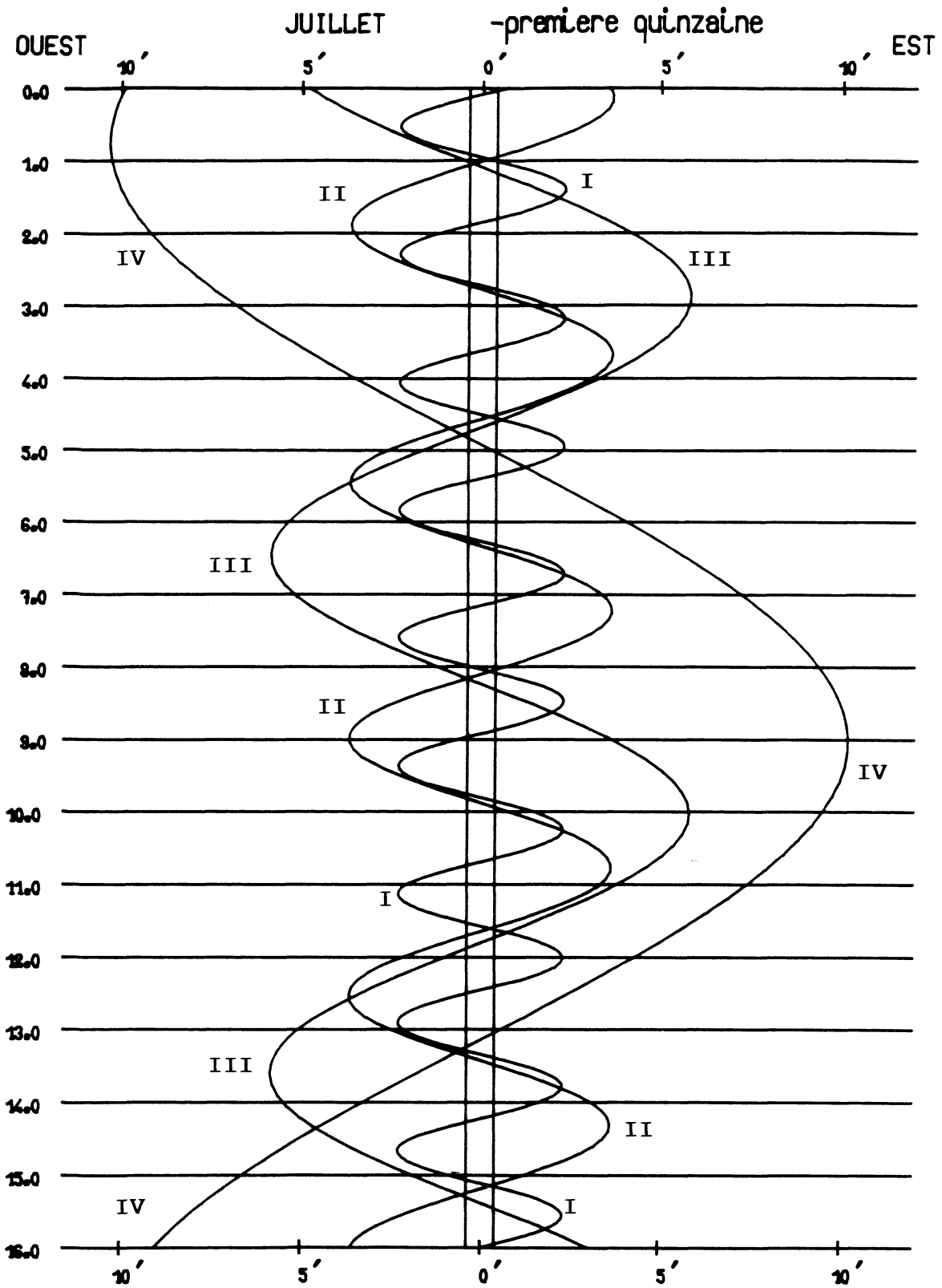

Dans le sens OUEST-EST, les satellites passent au-delà de Jupiter

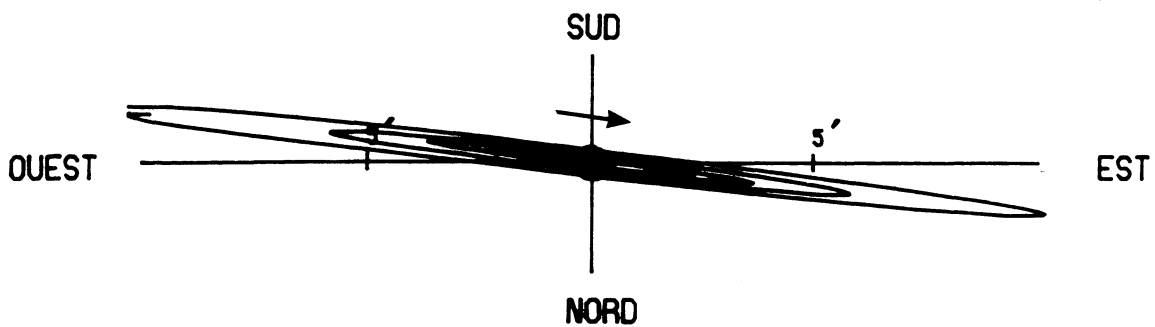

ORBITES APPARENTES

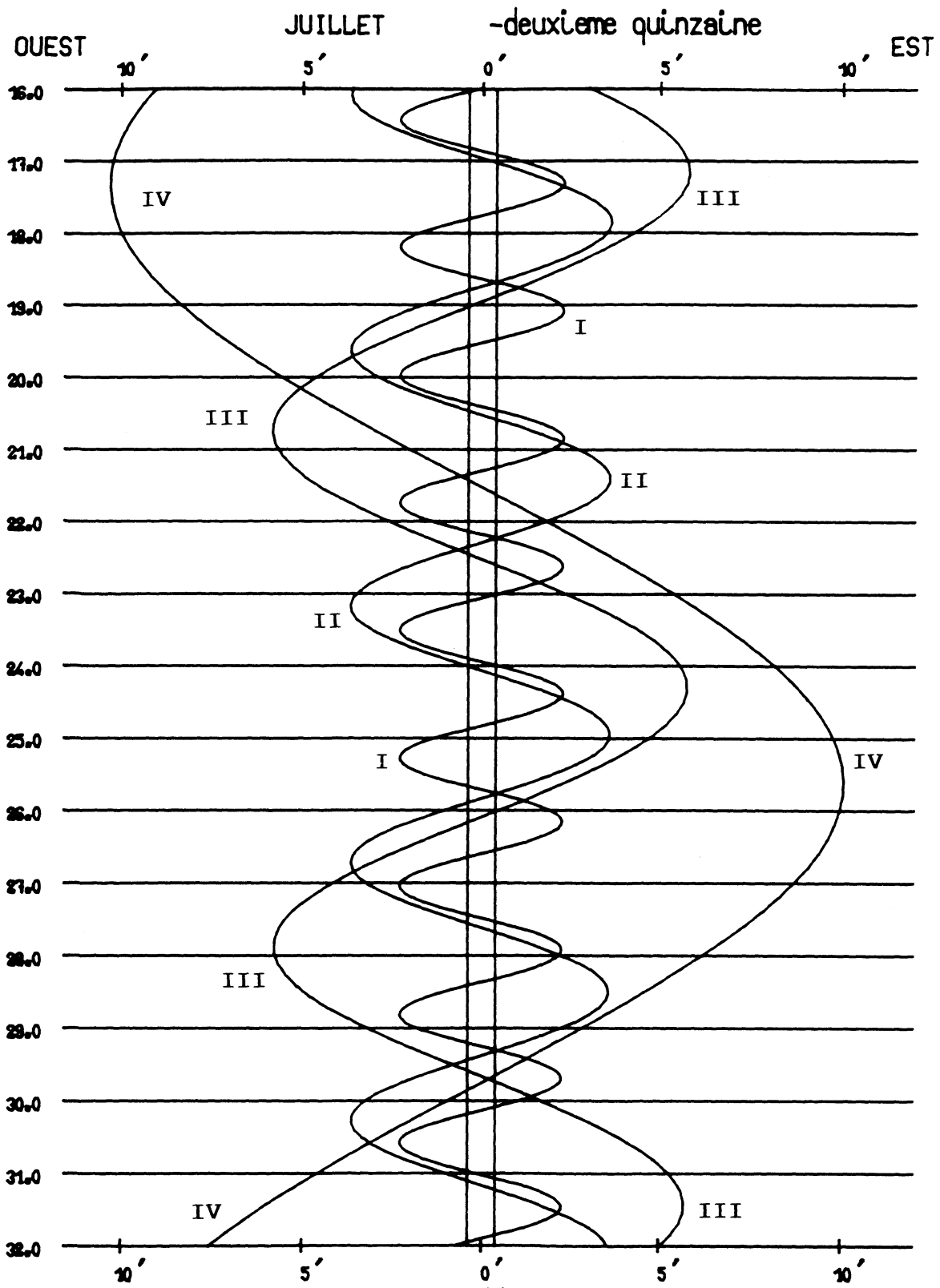

Dans le sens OUEST-EST, les satellites passent au-delà de Jupiter

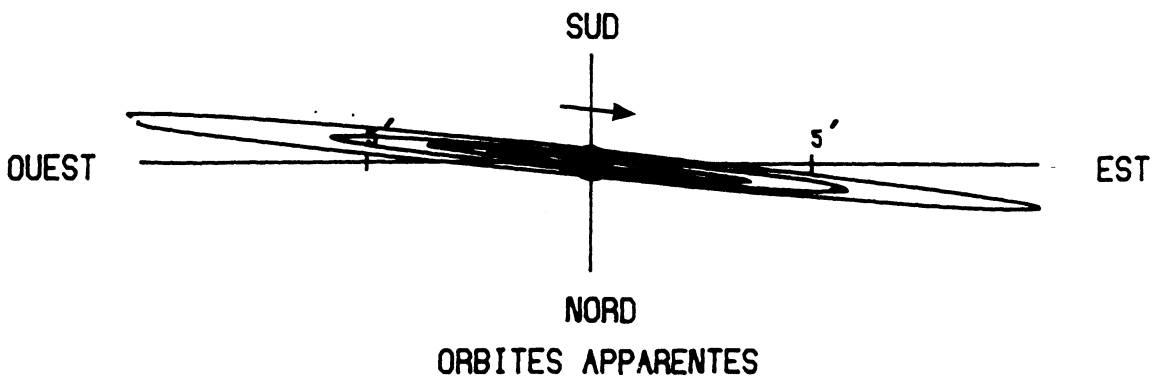

1996 - PHÉNOMÈNES DES SATELLITES GALILÉENS DE JUPITER
(Temps Terrestre)

PREMIÈRE QUINZAINE DE AOÛT																	
jour	h	m	s	SAT.	TYPE	jour	h	m	s	SAT.	TYPE	jour	h	m	s	SAT.	TYPE
1	17	58	4	I	OC.D.EXT	6	0	1	40	III	EC.F.EXT	22	46	55	II	EC.F.INT	
	18	1	43	I	OC.D.INT		0	5	2	III	EC.F.PEN	22	50	50	II	EC.F.EXT	
	20	52	34	I	EC.F.INT		4	7	53	I	PA.D.EXT	22	52	21	II	EC.F.PEN	
	20	56	13	I	EC.F.EXT		4	11	34	I	PA.D.INT						
	20	56	57	I	EC.F.PEN		4	52	40	I	OM.D.EXT	11	11	28	24	I	PA.D.EXT
	21	5	35	II	PA.D.EXT		4	56	21	I	OM.D.INT	11	32	5	I	PA.D.INT	
	21	9	28	II	PA.D.INT		6	23	6	I	PA.F.INT	12	19	6	I	OM.D.EXT	
	22	23	23	II	OM.D.EXT		6	26	47	I	PA.F.EXT	12	22	46	I	OM.D.INT	
	22	27	15	II	OM.D.INT		7	9	3	I	OM.F.INT	13	43	29	I	PA.F.INT	
	23	52	0	II	PA.F.INT		7	12	43	I	OM.F.EXT	13	47	10	I	PA.F.EXT	
	23	55	53	II	PA.F.EXT							14	35	23	I	OM.F.INT	
						7	1	17	36	I	OC.D.EXT	14	39	3	I	OM.F.EXT	
2	1	12	32	II	OM.F.INT		1	21	15	I	OC.D.INT						
	1	16	24	II	OM.F.EXT		4	18	35	I	EC.F.INT	12	8	37	41	I	OC.D.EXT
	4	4	2	III	PA.D.EXT		4	22	14	I	EC.F.EXT	8	41	21	I	OC.D.INT	
	4	13	40	III	PA.D.INT		4	22	58	I	EC.F.PEN	11	44	40	I	EC.F.INT	
	6	45	18	III	OM.D.EXT		5	3	6	II	OC.D.EXT	11	48	19	I	EC.F.EXT	
	6	54	46	III	OM.D.INT		5	7	3	II	OC.D.INT	11	49	3	I	EC.F.PEN	
	7	11	9	III	PA.F.INT		9	27	48	II	EC.F.INT	12	33	48	II	PA.D.EXT	
	7	20	48	III	PA.F.EXT		9	31	43	II	EC.F.EXT	12	37	41	II	PA.D.INT	
	9	59	35	III	OM.F.INT		9	33	14	II	EC.F.PEN	14	15	52	II	OM.D.EXT	
	10	9	2	III	OM.F.EXT		22	34	42	I	PA.D.EXT	14	19	43	II	OM.D.INT	
	15	14	32	I	PA.D.EXT		22	38	23	I	PA.D.INT	15	20	5	II	PA.F.INT	
	15	18	13	I	PA.D.INT		23	21	31	I	OM.D.EXT	15	23	58	II	PA.F.EXT	
	15	55	5	I	OM.D.EXT		23	25	12	I	OM.D.INT	17	5	9	II	OM.F.INT	
	15	58	46	I	OM.D.INT							17	9	0	II	OM.F.EXT	
	17	29	50	I	PA.F.INT	8	0	49	52	I	PA.F.INT	21	9	33	III	OC.D.EXT	
	17	33	31	I	PA.F.EXT		0	53	33	I	PA.F.EXT	21	19	8	III	OC.D.INT	
	18	11	31	I	OM.F.INT		1	37	52	I	OM.F.INT						
	18	15	12	I	OM.F.EXT		1	41	32	I	OM.F.EXT	13	0	17	52	III	OC.F.INT
							19	44	13	I	OC.D.EXT	0	27	26	III	OC.F.EXT	
3	12	24	32	I	OC.D.EXT		19	47	53	I	OC.D.INT	0	39	48	III	EC.D.PEN	
	12	28	12	I	OC.D.INT		22	47	16	I	EC.F.INT	0	43	9	III	EC.D.EXT	
	15	21	16	I	EC.F.INT		22	50	55	I	EC.F.EXT	0	52	35	III	EC.D.INT	
	15	24	55	I	EC.F.EXT		22	51	39	I	EC.F.PEN	3	52	32	III	EC.F.INT	
	15	25	39	I	EC.F.PEN		23	23	55	II	PA.D.EXT	4	1	58	III	EC.F.EXT	
	15	53	24	II	OC.D.EXT		23	27	47	II	PA.D.INT	4	5	19	III	EC.F.PEN	
	15	57	20	II	OC.D.INT							5	55	19	I	PA.D.EXT	
	20	9	24	II	EC.F.INT							5	59	0	I	PA.D.INT	
	20	13	20	II	EC.F.EXT	9	1	2	11	II	OM.D.INT	6	47	53	I	OM.D.EXT	
	20	14	51	II	EC.F.PEN		2	10	14	II	PA.F.INT	6	51	33	I	OM.D.INT	
4	9	41	13	I	PA.D.EXT		2	14	7	II	PA.F.EXT	8	10	22	I	PA.F.INT	
	9	44	54	I	PA.D.INT		3	47	34	II	OM.F.INT	8	14	2	I	PA.F.EXT	
	10	23	55	I	OM.D.EXT		3	51	25	II	OM.F.EXT	9	4	7	I	OM.F.INT	
	10	27	35	I	OM.D.INT		7	30	23	III	PA.D.EXT	9	7	47	I	OM.F.EXT	
	11	56	28	I	PA.F.INT		7	40	0	III	PA.D.INT						
	12	0	9	I	PA.F.EXT		10	37	29	III	PA.F.INT	14	3	4	31	I	OC.D.EXT
	12	40	19	I	OM.F.INT		10	45	42	III	OM.D.EXT	3	8	10	I	OC.D.INT	
	12	43	59	I	OM.F.EXT		10	47	8	III	PA.F.EXT	6	13	23	I	EC.F.INT	
							10	55	7	III	OM.D.INT	6	17	1	I	EC.F.EXT	
5	6	51	2	I	OC.D.EXT		14	0	34	III	OM.F.INT	6	17	46	I	EC.F.PEN	
	6	54	41	I	OC.D.INT		14	9	58	III	OM.F.EXT	7	24	47	II	OC.D.EXT	
	9	49	55	I	EC.F.INT		17	1	28	I	PA.D.EXT	7	28	44	II	OC.D.INT	
	9	53	34	I	EC.F.EXT		17	5	9	I	PA.D.INT	12	5	19	II	EC.F.INT	
	9	54	18	I	EC.F.PEN		17	50	16	I	OM.D.EXT	12	9	14	II	EC.F.EXT	
	10	14	31	II	PA.D.EXT		17	53	56	I	OM.D.INT	12	10	45	II	EC.F.PEN	
	10	18	24	II	PA.D.INT		19	16	36	I	PA.F.INT						
	11	40	50	II	OM.D.EXT		19	20	16	I	PA.F.EXT	15	0	22	24	I	PA.D.EXT
	11	44	42	II	OM.D.INT		20	6	34	I	OM.F.INT	0	26	4	I	PA.D.INT	
	13	0	53	II	PA.F.INT		20	10	14	I	OM.F.EXT	1	16	45	I	OM.D.EXT	
	13	4	46	II	PA.F.EXT							1	20	25	I	OM.D.INT	
	14	30	1	II	OM.F.INT	10	14	10	57	I	OC.D.EXT	2	37	24	I	PA.F.INT	
	14	33	53	II	OM.F.EXT		14	14	36	I	OC.D.INT	2	41	5	I	PA.F.EXT	
	17	42	23	III	OC.D.EXT		17	15	59	I	EC.F.INT	3	32	58	I	OM.F.INT	
	17	51	57	III	OC.D.INT		17	19	38	I	EC.F.EXT	3	36	38	I	OM.F.EXT	
	23	52	11	III	EC.F.INT		17	20	22	I	EC.F.PEN	21	31	25	I	OC.D.EXT	
							18	14	5	II	OC.D.EXT	21	35	4	I	OC.D.INT	
							18	18	2	II	OC.D.INT						

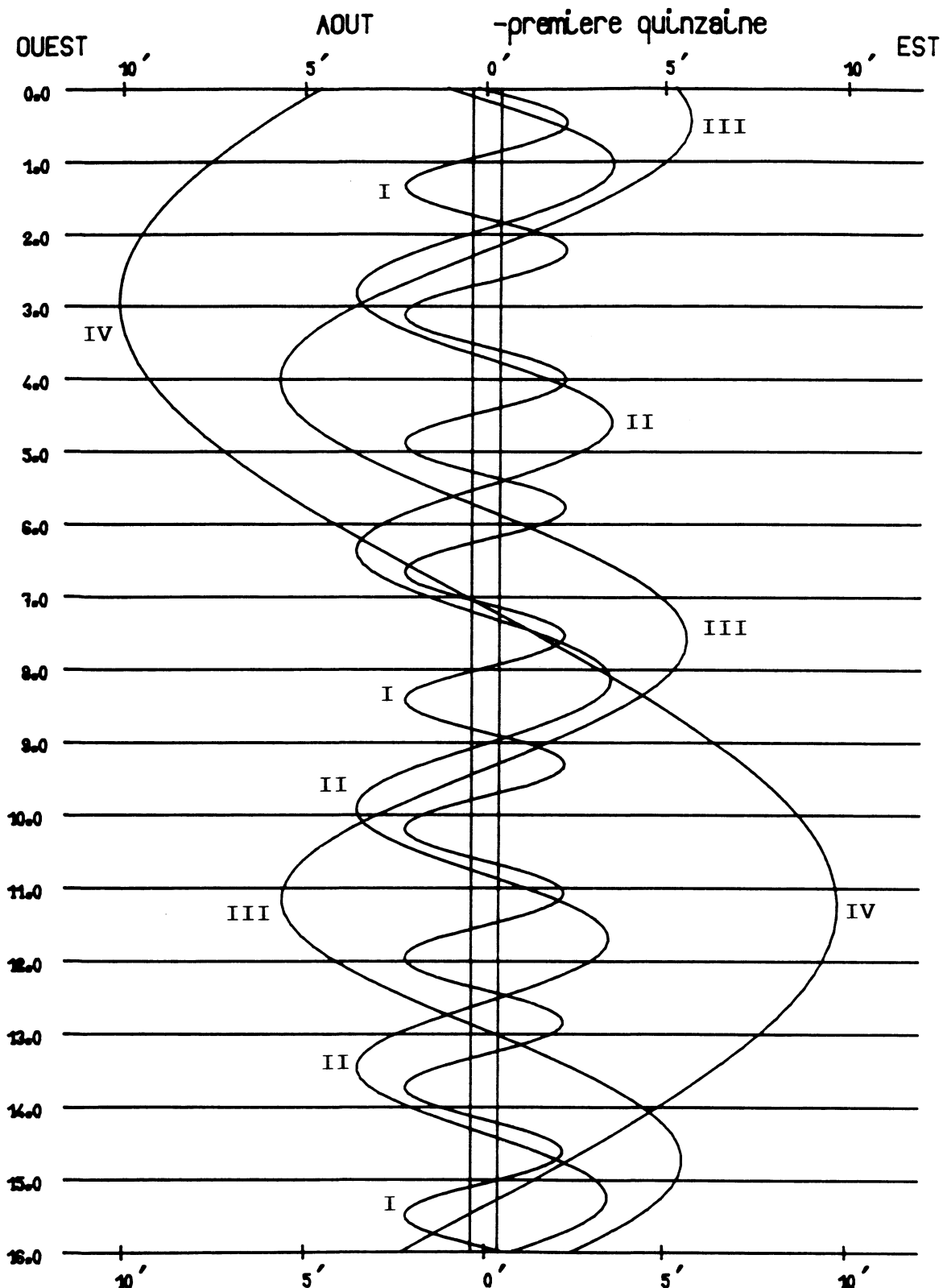

Dans le sens OUEST-EST, les satellites passent au-delà de Jupiter

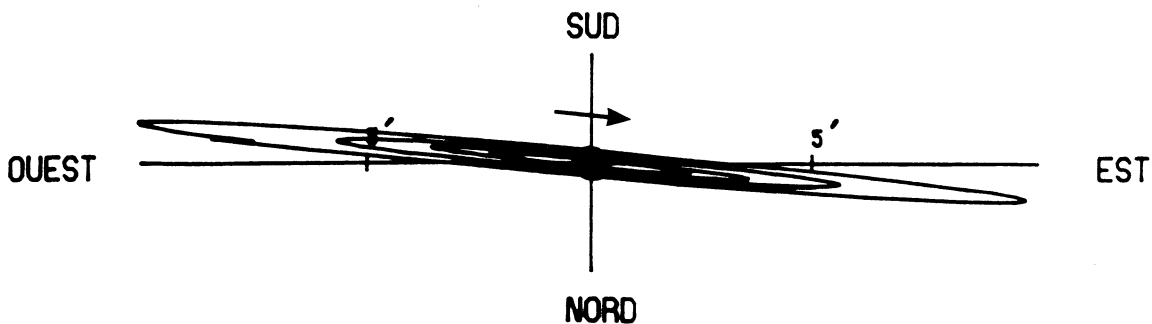

ORBITES APPARENTES

1996 - PHÉNOMÈNES DES SATELLITES GALILÉENS DE JUPITER
(Temps Terrestre)

DEUXIÈME QUINZAINE DE AOÛT																	
jour	h	m	s	SAT.	TYPE	jour	h	m	s	SAT.	TYPE	jour	h	m	s	SAT.	TYPE
16	0	42	5	I	EC.F.INT							20	5	1	II	PA.F.INT	
	0	45	43	I	EC.F.EXT	21	4	52	32	I	OC.D.EXT	20	8	54	II	PA.F.EXT	
	0	46	28	I	EC.F.PEN		4	56	12	I	OC.D.INT	22	16	0	II	OM.F.INT	
	1	44	11	II	PA.D.EXT		8	8	17	I	EC.F.INT	22	19	51	II	OM.F.EXT	
	1	48	4	II	PA.D.INT		8	11	56	I	EC.F.EXT						
	3	33	25	II	OM.D.EXT		8	12	40	I	EC.F.PEN	27	4	17	42	III	OC.D.EXT
	3	37	17	II	OM.D.INT		9	48	35	II	OC.D.EXT	4	27	16	III	OC.D.INT	
	4	30	26	II	PA.F.INT		9	52	32	II	OC.D.INT	7	26	43	III	OC.F.INT	
	4	34	19	II	PA.F.EXT		14	42	51	II	EC.F.INT	7	36	16	III	OC.F.EXT	
	6	22	46	II	OM.F.INT		14	46	45	II	EC.F.EXT	8	40	9	III	EC.D.PEN	
	6	26	37	II	OM.F.EXT		14	48	16	II	EC.F.PEN	8	43	29	III	EC.D.EXT	
	10	59	57	III	PA.D.EXT							8	52	49	III	EC.D.INT	
	11	9	33	III	PA.D.INT	22	2	11	10	I	PA.D.EXT	9	33	27	I	PA.D.EXT	
	14	7	5	III	PA.F.INT		2	14	51	I	PA.D.INT	9	37	7	I	PA.D.INT	
	14	16	43	III	PA.F.EXT		3	12	2	I	OM.D.EXT	10	38	29	I	OM.D.EXT	
	14	45	28	III	OM.D.EXT		3	15	42	I	OM.D.INT	10	42	9	I	OM.D.INT	
	14	54	50	III	OM.D.INT		4	26	1	I	PA.F.INT	11	48	11	I	PA.F.INT	
	18	0	55	III	OM.F.INT		4	29	42	I	PA.F.EXT	11	51	52	I	PA.F.EXT	
	18	10	16	III	OM.F.EXT		5	28	7	I	OM.F.INT	11	54	36	III	EC.F.INT	
	18	49	25	I	PA.D.EXT		5	31	47	I	OM.F.EXT	12	3	57	III	EC.F.EXT	
	18	53	6	I	PA.D.INT		23	19	43	I	OC.D.EXT	12	7	16	III	EC.F.PEN	
	19	45	30	I	OM.D.EXT		23	23	22	I	OC.D.INT	12	54	28	I	OM.F.INT	
	19	49	10	I	OM.D.INT							12	58	8	I	OM.F.EXT	
	21	4	23	I	PA.F.INT	23	2	37	0	I	EC.F.INT						
	21	8	4	I	PA.F.EXT		2	40	39	I	EC.F.EXT	28	6	41	43	I	OC.D.EXT
	22	1	41	I	OM.F.INT		2	41	23	I	EC.F.PEN	6	45	22	I	OC.D.INT	
	22	5	21	I	OM.F.EXT		4	6	40	II	PA.D.EXT	10	3	17	I	EC.F.INT	
17	15	58	24	I	OC.D.EXT		4	10	33	II	PA.D.INT	10	6	56	I	EC.F.EXT	
	16	2	4	I	OC.D.INT		6	8	44	II	OM.D.EXT	10	7	40	I	EC.F.PEN	
	19	10	50	I	EC.F.INT		6	12	36	II	OM.D.INT	12	14	34	II	OC.D.EXT	
	19	14	29	I	EC.F.EXT		6	52	53	II	PA.F.INT	12	18	30	II	OC.D.INT	
	19	15	13	I	EC.F.PEN		6	56	46	II	PA.F.EXT	17	20	18	II	EC.F.INT	
	20	36	49	II	OC.D.EXT		8	58	11	II	OM.F.INT	17	24	12	II	EC.F.EXT	
	20	40	46	II	OC.D.INT		9	2	2	II	OM.F.EXT	17	25	43	II	EC.F.PEN	
18	1	24	26	II	EC.F.INT		14	33	42	III	PA.D.EXT						
	1	28	21	II	EC.F.EXT		14	43	17	III	PA.D.INT	29	4	1	5	I	PA.D.EXT
	1	29	52	II	EC.F.PEN		17	40	57	III	PA.F.INT	4	4	46	I	PA.D.INT	
	13	16	37	I	PA.D.EXT		17	50	34	III	PA.F.EXT	5	7	23	I	OM.D.EXT	
	13	20	18	I	PA.D.INT		18	45	12	III	OM.D.EXT	5	11	2	I	OM.D.INT	
	14	14	22	I	OM.D.EXT		18	54	31	III	OM.D.INT	6	15	47	I	PA.F.INT	
	14	18	2	I	OM.D.INT		20	38	29	I	PA.D.EXT	6	19	28	I	PA.F.EXT	
	15	31	33	I	PA.F.INT		20	42	10	I	PA.D.INT	7	23	20	I	OM.F.INT	
	15	35	13	I	PA.F.EXT		21	40	49	I	OM.D.EXT	7	27	0	I	OM.F.EXT	
	16	30	31	I	OM.F.INT		21	44	28	I	OM.D.INT						
	16	34	10	I	OM.F.EXT		22	1	14	III	OM.F.INT	30	1	9	11	I	OC.D.EXT
19	10	25	26	I	OC.D.EXT		22	10	32	III	OM.F.EXT	1	12	50	I	OC.D.INT	
	10	29	5	I	OC.D.INT		22	53	18	I	PA.F.INT	4	32	2	I	EC.F.INT	
	13	39	33	I	EC.F.INT		22	56	58	I	PA.F.EXT	4	35	41	I	EC.F.EXT	
	13	43	11	I	EC.F.EXT	24	0	0	31	I	OM.F.EXT	4	36	25	I	EC.F.PEN	
	13	43	56	I	EC.F.PEN		17	47	0	I	OC.D.EXT	6	31	27	II	PA.D.EXT	
	14	55	9	II	PA.D.EXT		17	50	39	I	OC.D.INT	6	35	20	II	PA.D.INT	
	14	59	2	II	PA.D.INT		21	5	47	I	EC.F.INT	8	44	16	II	OM.D.EXT	
	16	51	3	II	OM.D.EXT		21	9	26	I	EC.F.EXT	8	48	8	II	OM.D.INT	
	16	54	55	II	OM.D.INT		21	10	10	I	EC.F.PEN	9	17	41	II	PA.F.INT	
	17	41	23	II	PA.F.INT		23	1	40	II	OC.D.EXT	9	21	34	II	PA.F.EXT	
	17	45	16	II	PA.F.EXT		23	5	36	II	OC.D.INT	11	33	51	II	OM.F.INT	
	19	40	27	II	OM.F.INT	25	4	1	54	II	EC.F.INT	11	37	42	II	OM.F.EXT	
	19	44	18	II	OM.F.EXT		4	5	48	II	EC.F.EXT	18	11	59	III	PA.D.EXT	
20	0	41	37	III	OC.D.EXT		4	7	18	II	EC.F.PEN	18	21	33	III	PA.D.INT	
	0	51	11	III	OC.D.INT		15	5	58	I	PA.D.EXT	21	19	27	III	PA.F.INT	
	3	50	15	III	OC.F.INT		15	9	39	I	PA.D.INT	21	29	4	III	PA.F.EXT	
	3	59	50	III	OC.F.EXT		16	9	41	I	OM.D.EXT	22	28	41	I	PA.D.EXT	
	4	40	11	III	EC.D.PEN		16	13	21	I	OM.D.INT	22	32	21	I	PA.D.INT	
	4	43	31	III	EC.D.EXT		17	20	44	I	PA.F.INT	22	45	6	III	OM.D.EXT	
	4	52	54	III	EC.D.INT		17	24	25	I	PA.F.EXT	22	54	23	III	OM.D.INT	
	7	43	49	I	PA.D.EXT		18	25	42	I	OM.F.INT	23	36	10	I	OM.D.EXT	
	7	47	29	I	PA.D.INT		18	29	22	I	OM.F.EXT	23	39	49	I	OM.D.INT	
	7	53	47	III	EC.F.INT	26	12	14	18	I	OC.D.EXT	31	0	43	21	I	PA.F.INT
	8	3	11	III	EC.F.EXT		12	17	58	I	OC.D.INT	0	47	2	I	PA.F.EXT	
	8	6	31	III	EC.F.PEN		15	34	31	I	EC.F.INT	1	52	6	I	OM.F.INT	
	8	43	9	I	OM.D.EXT		15	38	10	I	EC.F.EXT	1	55	45	I	OM.F.EXT	
	8	46	49	I	OM.D.INT		15	38	54	I	EC.F.PEN	2	1	46	III	OM.F.INT	
	9	58	42	I	PA.F.INT		17	18	48	II	PA.D.EXT	2	11	1	III	OM.F.EXT	
	10	2	23	I	PA.F.EXT		17	22	41	II	PA.D.INT	19	36	46	I	OC.D.EXT	
	10	59	16	I	OM.F.INT		17	22	40	II	OM.D.EXT	19	40	25	I	OC.D.INT	
	11	2	56	I	OM.F.EXT		19	26	30	II	OM.D.EXT	23	0	51	I	EC.F.INT	
							19	30	21	II	OM.D.INT	23	4	29	I	EC.F.EXT	
												23	5	14	I	EC.F.PEN	

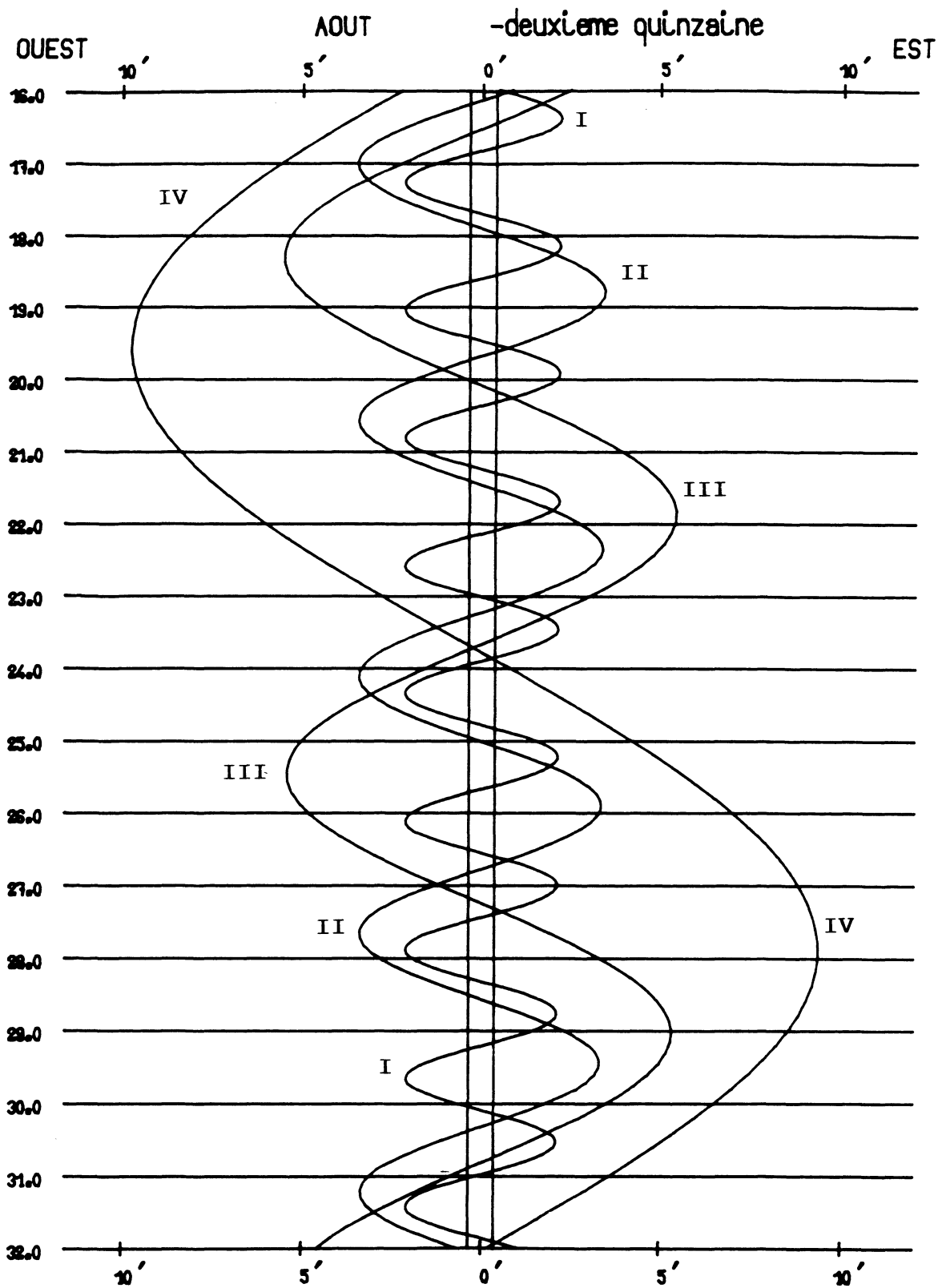

Dans le sens OUEST-EST, les satellites passent au-delà de Jupiter

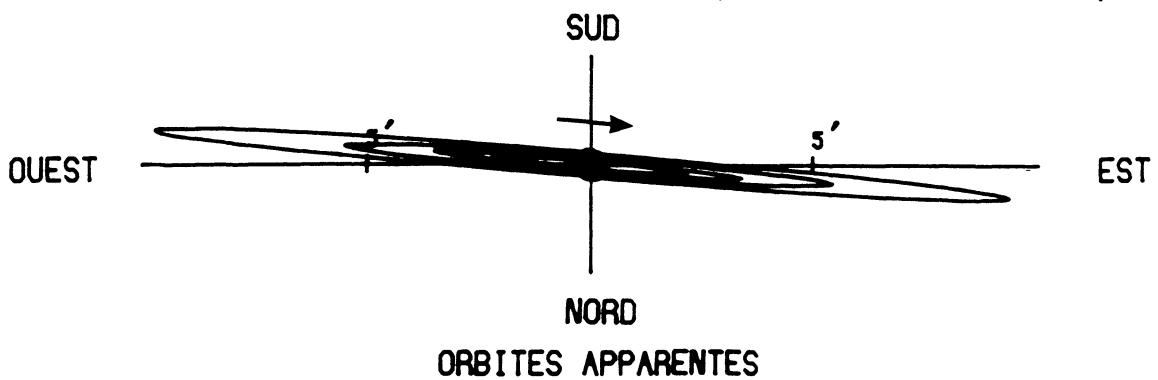

1996 - PHÉNOMÈNES DES SATELLITES GALILÉENS DE JUPITER

(Temps Terrestre)

PREMIÈRE QUINZAINE DE SEPTEMBRE																					
jour	h	m	s	SAT.	TYPE	jour	h	m	s	SAT.	TYPE	jour	h	m	s	SAT.	TYPE				
1	1	28	46	II	OC.D.EXT	9	2	27	II	PA.D.INT	19	56	28	III	EC.F.INT						
	1	32	42	II	OC.D.INT		11	19	59	II		OM.D.EXT	20	5	43	III	EC.F.EXT				
	6	39	18	II	EC.F.INT		11	23	50	II		OM.D.INT	20	9	1	III	EC.F.PEN				
	6	43	12	II	EC.F.EXT		11	44	52	II		PA.F.INT	11	10	23	36	I	OC.D.EXT			
	6	44	42	II	EC.F.PEN		11	48	45	II		PA.F.EXT		10	27	16	I	OC.D.INT			
	16	56	27	I	PA.D.EXT		14	9	44	II		OM.F.INT		13	53	35	I	EC.F.INT			
	17	0	7	I	PA.D.INT		14	13	35	II		OM.F.EXT		13	57	13	I	EC.F.EXT			
	18	5	2	I	OM.D.EXT		21	55	3	III		PA.D.EXT		13	57	58	I	EC.F.PEN			
	18	8	42	I	OM.D.INT		22	4	36	III		PA.D.INT		17	13	18	II	OC.D.EXT			
	19	11	5	I	PA.F.INT		7	0	20	1		I		PA.D.EXT	17	17	14	II	OC.D.INT		
	19	14	46	I	PA.F.EXT			0	23	41		I		PA.D.INT	22	35	3	II	EC.F.INT		
	20	20	57	I	OM.F.INT			1	2	51		III		PA.F.INT	22	38	56	II	EC.F.EXT		
	20	24	36	I	OM.F.EXT			1	12	26		III		PA.F.EXT	22	40	26	II	EC.F.PEN		
	2	14	4	22	I			OC.D.EXT	1	31		33		I	OM.D.EXT	12	7	44	19	I	PA.D.EXT
		14	8	1	I			OC.D.INT	1	35		12		I	OM.D.INT		7	47	59	I	PA.D.INT
17		29	36	I	EC.F.INT	2		34	35	I	PA.F.INT	8		58	9		I	OM.D.EXT			
17		33	15	I	EC.F.EXT	2		38	15	I	PA.F.EXT	9		1	48		I	OM.D.INT			
17		33	59	I	EC.F.PEN	2		45	14	III	OM.D.EXT	9		58	48		I	PA.F.INT			
19		44	44	II	PA.D.EXT	2		54	28	III	OM.D.INT	10	2	29	I		PA.F.EXT				
19		48	37	II	PA.D.INT	3		47	23	I	OM.F.INT	11	13	55	I		OM.F.INT				
22		2	6	II	OM.D.EXT	3		51	2	I	OM.F.EXT	11	17	34	I		OM.F.EXT				
22		5	57	II	OM.D.INT	6		2	32	III	OM.F.INT	13	4	51	39		I	OC.D.EXT			
22		30	59	II	PA.F.INT	6		11	45	III	OM.F.EXT		4	55	19		I	OC.D.INT			
22		34	52	II	PA.F.EXT	21		27	42	I	OC.D.EXT		8	22	21		I	EC.F.INT			
3		0	51	45	II	OM.F.INT	21	31	22	I	OC.D.INT		8	26	0		I	EC.F.EXT			
		0	55	36	II	OM.F.EXT	8	0	56	0	I		EC.F.INT	8	26		44	I	EC.F.PEN		
		7	58	54	III	OC.D.EXT		0	59	38	I		EC.F.EXT	11	28		4	II	PA.D.EXT		
		8	8	26	III	OC.D.INT		1	0	22	I		EC.F.PEN	11	31		57	II	PA.D.INT		
	11	8	19	III	OC.F.INT	3		58	6	II	OC.D.EXT		13	55	57	II	OM.D.EXT				
	11	17	52	III	OC.F.EXT	4		2	2	II	OC.D.INT		13	59	48	II	OM.D.INT				
	11	24	13	I	PA.D.EXT	9		16	39	II	EC.F.INT		14	14	31	II	PA.F.INT				
	11	27	53	I	PA.D.INT	9		20	32	II	EC.F.EXT		14	18	24	II	PA.F.EXT				
	12	33	51	I	OM.D.EXT	9		22	2	II	EC.F.PEN		16	45	53	II	OM.F.INT				
	12	37	31	I	OM.D.INT	18		48	4	I	PA.D.EXT		16	49	44	II	OM.F.EXT				
	12	40	38	III	EC.D.PEN	18		51	44	I	PA.D.INT		14	1	43	36	III	PA.D.EXT			
	12	43	57	III	EC.D.EXT	20		0	26	I	OM.D.EXT			1	53	8	III	PA.D.INT			
	12	53	15	III	EC.D.INT	20		4	5	I	OM.D.INT	2		12	28	I	PA.D.EXT				
	13	38	49	I	PA.F.INT	21		2	36	I	PA.F.INT	2		16	9	I	PA.D.INT				
	13	42	30	I	PA.F.EXT	21		6	16	I	PA.F.EXT	3		26	57	I	OM.D.EXT				
14	49	44	I	OM.F.INT	22	16		14	I	OM.F.INT	3	30		36	I	OM.D.INT					
14	53	23	I	OM.F.EXT	22	19	53	I	OM.F.EXT	4	26	57		I	PA.F.INT						
15	55	54	III	EC.F.INT	9	15	55	36	I	OC.D.EXT	4	30		38	I	PA.F.EXT					
16	5	12	III	EC.F.EXT		15	59	16	I	OC.D.INT	4	51		49	III	PA.F.INT					
16	8	30	III	EC.F.PEN		19	24	46	I	EC.F.INT	5	1		23	III	PA.F.EXT					
4	8	32	4	I		OC.D.EXT	19	28	25	I	EC.F.EXT	5		42	42	I	OM.F.INT				
	8	35	43	I		OC.D.INT	19	29	9	I	EC.F.PEN	5		46	21	I	OM.F.EXT				
	11	58	24	I		EC.F.INT	22	13	1	II	PA.D.EXT	6		46	17	III	OM.D.EXT				
	12	2	2	I		EC.F.EXT	22	16	55	II	PA.D.INT	6		55	29	III	OM.D.INT				
	12	2	47	I		EC.F.PEN	10	0	37	55	II	OM.D.EXT		10	4	16	III	OM.F.INT			
	14	42	50	II		OC.D.EXT		0	41	46	II	OM.D.INT	10	13	27	III	OM.F.EXT				
	14	46	46	II		OC.D.INT		0	59	23	II	PA.F.INT	23	19	50	I	OC.D.EXT				
	19	57	45	II		EC.F.INT		1	3	16	II	PA.F.EXT	23	23	29	I	OC.D.INT				
	20	1	38	II		EC.F.EXT		3	27	44	II	OM.F.INT	15	2	51	13	I	EC.F.INT			
	20	3	8	II		EC.F.PEN		3	31	35	II	OM.F.EXT		2	54	51	I	EC.F.EXT			
	5	5	52	8		I		PA.D.EXT	11	43	54	III		OC.D.EXT	2	55	36	I	EC.F.PEN		
		5	55	48		I		PA.D.INT	11	53	26	III		OC.D.INT	6	29	39	II	OC.D.EXT		
		7	2	45	I	OM.D.EXT		13	16	6	I	PA.D.EXT		6	33	35	II	OC.D.INT			
		7	6	25	I	OM.D.INT		13	19	47	I	PA.D.INT		11	53	52	II	EC.F.INT			
		8	6	43	I	PA.F.INT		14	29	15	I	OM.D.EXT		11	57	45	II	EC.F.EXT			
8		10	24	I	PA.F.EXT	14		32	54	I	OM.D.INT	11		59	15	II	EC.F.PEN				
9		18	36	I	OM.F.INT	14		53	48	III	OC.F.INT	20		40	47	I	PA.D.EXT				
9		22	16	I	OM.F.EXT	15		3	20	III	OC.F.EXT	20		44	28	I	PA.D.INT				
6		2	59	49	I	OC.D.EXT		15	30	37	I	PA.F.INT		21	55	50	I	OM.D.EXT			
		3	3	29	I	OC.D.INT	15	34	18	I	PA.F.EXT	21		59	29	I	OM.D.INT				
		6	27	9	I	EC.F.INT	16	40	24	III	EC.D.PEN	22		55	15	I	PA.F.INT				
		6	30	48	I	EC.F.EXT	16	43	42	III	EC.D.EXT	22		58	56	I	PA.F.EXT				
		6	31	32	I	EC.F.PEN	16	45	2	I	OM.F.INT	16		2	51	13	I	EC.F.INT			
		6	31	32	I	EC.F.EXT	16	48	41	I	OM.F.EXT		2	54	51	I	EC.F.EXT				
		8	58	33	II	PA.D.EXT	16	52	57	III	EC.D.INT		2	55	36	I	EC.F.PEN				

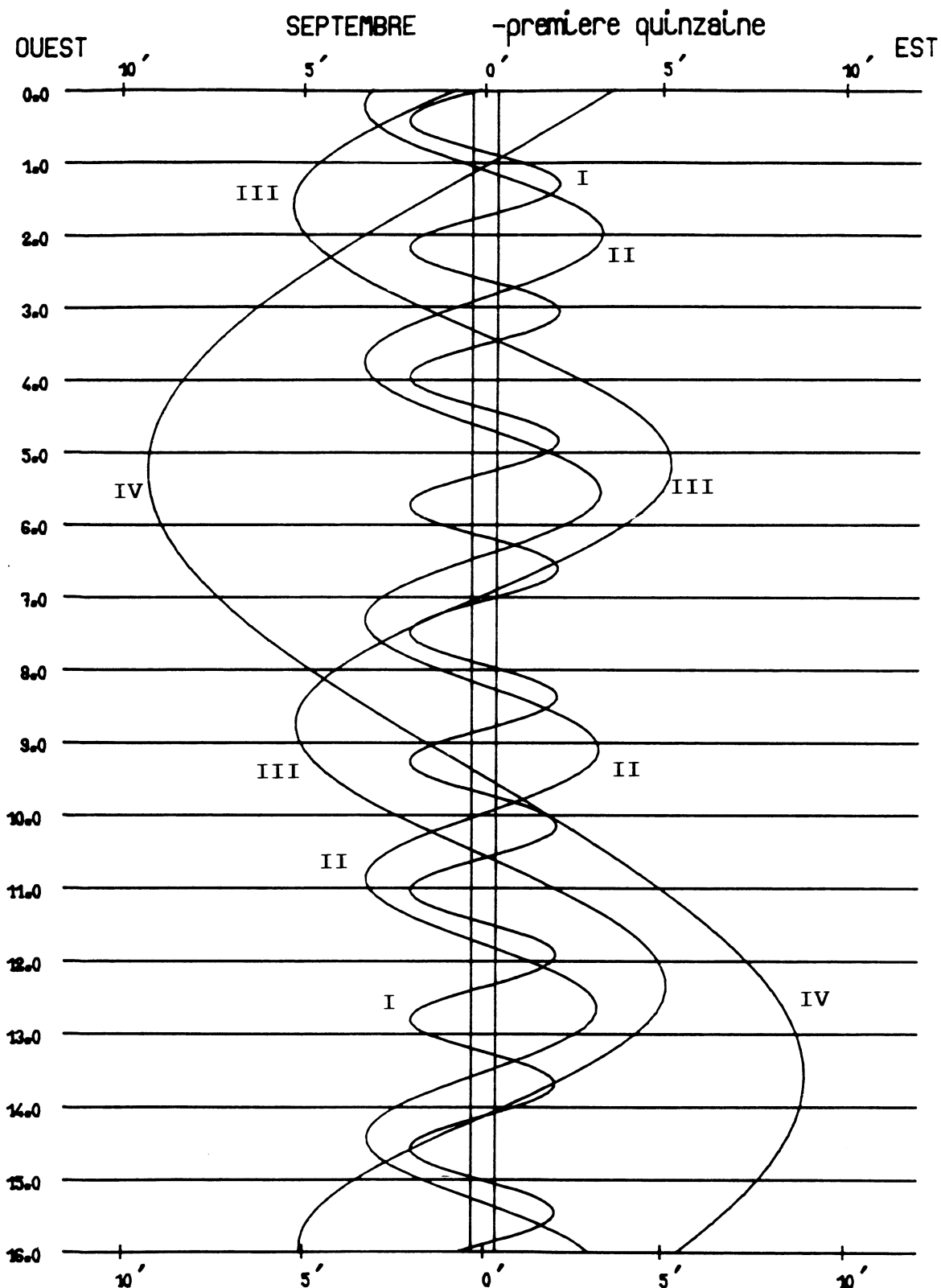

Dans le sens OUEST-EST, les satellites passent au-delà de Jupiter

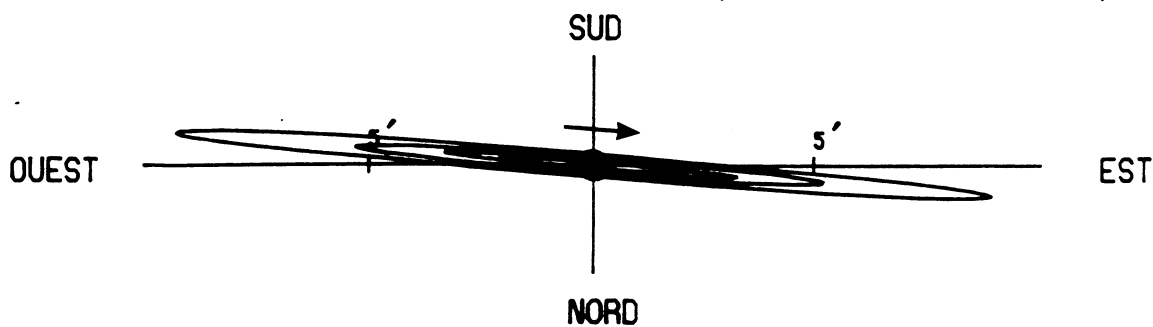

ORBITES APPARENTES

1996 - PHÉNOMÈNES DES SATELLITES GALILÉENS DE JUPITER
(Temps Terrestre)

DEUXIÈME QUINZAINE DE SEPTEMBRE

jour	h	m	s	SAT.	TYPE	jour	h	m	s	SAT.	TYPE	jour	h	m	s	SAT.	TYPE
16	0	11	34	I	OM.F.INT	4	9	41	I	PA.D.INT	17	44	9	I	EC.F.INT		
	0	15	13	I	OM.F.EXT	5	22	21	I	OM.D.EXT	17	47	48	I	EC.F.EXT		
	17	48	1	I	OC.D.EXT	5	26	0	I	OM.D.INT	17	48	32	I	EC.F.PEN		
	17	51	41	I	OC.D.INT	5	36	9	III	PA.D.EXT	22	20	47	II	OC.D.EXT		
	21	20	0	I	EC.F.INT	5	45	39	III	PA.D.INT	22	24	42	II	OC.D.INT		
	21	23	39	I	EC.F.EXT	6	20	27	I	PA.F.INT							
	21	24	23	I	EC.F.PEN	6	24	7	I	PA.F.EXT	26	3	49	22	II	EC.F.INT	
						7	38	4	I	OM.F.INT	3	53	14	II	EC.F.EXT		
17	0	43	39	II	PA.D.EXT	7	41	43	I	OM.F.EXT	3	54	43	II	EC.F.PEN		
	0	47	32	II	PA.D.INT	8	44	51	III	PA.F.INT	11	31	54	I	PA.D.EXT		
	3	13	55	II	OM.D.EXT	8	54	24	III	PA.F.EXT	11	35	34	I	PA.D.INT		
	3	17	46	II	OM.D.INT	10	46	43	III	OM.D.EXT	12	48	57	I	OM.D.EXT		
	3	30	11	II	PA.F.INT	10	55	53	III	OM.D.INT	12	52	36	I	OM.D.INT		
	3	34	4	II	PA.F.EXT	14	5	23	III	OM.F.INT	13	46	19	I	PA.F.INT		
	6	3	57	II	OM.F.INT	14	14	31	III	OM.F.EXT	13	49	59	I	PA.F.EXT		
	6	7	48	II	OM.F.EXT						15	4	38	I	OM.F.INT		
	15	9	7	I	PA.D.EXT	22	1	13	6	I	OC.D.EXT	15	8	17	I	OM.F.EXT	
	15	12	47	I	PA.D.INT	1	16	46	I	OC.D.INT							
	15	33	22	III	OC.D.EXT	4	46	30	I	EC.F.INT	27	8	38	45	I	OC.D.EXT	
	15	42	52	III	OC.D.INT	4	50	9	I	EC.F.EXT	8	42	24	I	OC.D.INT		
	16	24	39	I	OM.D.EXT	4	50	53	I	EC.F.PEN	12	12	57	I	EC.F.INT		
	16	28	18	I	OM.D.INT	9	3	25	II	OC.D.EXT	12	16	36	I	EC.F.EXT		
	17	23	34	I	PA.F.INT	9	7	20	II	OC.D.INT	12	17	20	I	EC.F.PEN		
	17	27	14	I	PA.F.EXT	14	31	2	II	EC.F.INT	16	33	56	II	PA.D.EXT		
	18	40	23	I	OM.F.INT	14	34	54	II	EC.F.EXT	16	37	50	II	PA.D.INT		
	18	43	49	III	OC.F.INT	14	36	24	II	EC.F.PEN	19	8	22	II	OM.D.EXT		
	18	44	2	I	OM.F.EXT	22	34	35	I	PA.D.EXT	19	12	13	II	OM.D.INT		
	18	53	19	III	OC.F.EXT	22	38	15	I	PA.D.INT	19	20	53	II	PA.F.INT		
	20	40	4	III	EC.D.PEN	23	51	14	I	OM.D.EXT	19	24	46	II	PA.F.EXT		
	20	43	21	III	EC.D.EXT	23	54	53	I	OM.D.INT	21	58	51	II	OM.F.INT		
	20	52	34	III	EC.D.INT						22	2	42	II	OM.F.EXT		
	23	56	56	III	EC.F.INT	23	0	49	1	I	PA.F.INT						
18	0	6	9	III	EC.F.EXT	0	52	41	I	PA.F.EXT	28	6	0	35	I	PA.D.EXT	
	0	9	26	III	EC.F.PEN	2	6	56	I	OM.F.INT	6	4	15	I	PA.D.INT		
	12	16	19	I	OC.D.EXT	2	10	35	I	OM.F.EXT	7	17	45	I	OM.D.EXT		
	12	19	58	I	OC.D.INT	19	41	34	I	OC.D.EXT	7	21	24	I	OM.D.INT		
	15	48	50	I	EC.F.INT	19	45	14	I	OC.D.INT	8	15	0	I	PA.F.INT		
	15	52	29	I	EC.F.EXT	23	15	18	I	EC.F.INT	8	18	40	I	PA.F.EXT		
	15	53	13	I	EC.F.PEN	23	18	57	I	EC.F.EXT	9	33	27	I	OM.F.INT		
	19	46	0	II	OC.D.EXT	23	19	41	I	EC.F.PEN	9	33	28	III	PA.D.EXT		
	19	49	56	II	OC.D.INT						9	37	5	I	OM.F.EXT		
19	1	12	16	II	EC.F.INT	24	3	16	34	II	PA.D.EXT	9	42	56	III	PA.D.INT	
	1	16	9	II	EC.F.EXT	3	20	27	II	PA.D.INT	12	42	46	III	PA.F.INT		
	1	17	39	II	EC.F.PEN	5	50	6	II	OM.D.EXT	12	52	17	III	PA.F.EXT		
	9	37	35	I	PA.D.EXT	5	53	57	II	OM.D.INT	14	47	29	III	OM.D.EXT		
	9	41	15	I	PA.D.INT	6	3	21	II	PA.F.INT	14	56	36	III	OM.D.INT		
	10	53	33	I	OM.D.EXT	6	7	14	II	PA.F.EXT	18	6	51	III	OM.F.INT		
	10	57	12	I	OM.D.INT	8	40	24	II	OM.F.INT	18	15	56	III	OM.F.EXT		
	11	52	1	I	PA.F.INT	8	44	15	II	OM.F.EXT							
	11	55	41	I	PA.F.EXT	17	3	10	I	PA.D.EXT	29	3	7	29	I	OC.D.EXT	
	13	9	16	I	OM.F.INT	17	6	50	I	PA.D.INT	3	11	8	I	OC.D.INT		
	13	12	55	I	OM.F.EXT	18	20	3	I	OM.D.EXT	6	41	51	I	EC.F.INT		
20	6	44	39	I	OC.D.EXT	18	23	42	I	OM.D.INT	6	45	29	I	EC.F.EXT		
	6	48	18	I	OC.D.INT	19	17	35	I	PA.F.INT	6	46	14	I	EC.F.PEN		
	10	17	38	I	EC.F.INT	19	21	16	I	PA.F.EXT	11	39	10	II	OC.D.EXT		
	10	21	16	I	EC.F.EXT	19	27	23	III	OC.D.EXT	11	43	5	II	OC.D.INT		
	10	22	1	I	EC.F.PEN	19	36	52	III	OC.D.INT	17	8	1	II	EC.F.INT		
	13	59	51	II	PA.D.EXT	20	35	45	I	OM.F.INT	17	11	53	II	EC.F.EXT		
	14	3	45	II	PA.D.INT	20	39	23	I	OM.F.EXT	17	13	23	II	EC.F.PEN		
	16	32	3	II	OM.D.EXT	22	38	28	III	OC.F.INT							
	16	35	54	II	OM.D.INT	22	47	57	III	OC.F.EXT	30	0	29	24	I	PA.D.EXT	
	16	46	31	II	PA.F.INT						0	33	4	I	PA.D.INT		
	16	50	25	II	PA.F.EXT	25	0	39	58	III	EC.D.PEN	1	46	37	I	OM.D.EXT	
	19	22	14	II	OM.F.INT	0	43	14	III	EC.D.EXT	1	50	16	I	OM.D.INT		
	19	26	5	II	OM.F.EXT	0	52	24	III	EC.D.INT	2	43	49	I	PA.F.INT		
						3	57	39	III	EC.F.INT	2	47	29	I	PA.F.EXT		
21	4	6	1	I	PA.D.EXT	4	6	49	III	EC.F.EXT	4	2	19	I	OM.F.INT		
						4	10	6	III	EC.F.PEN	4	5	57	I	OM.F.EXT		
						14	10	9	I	OC.D.EXT	21	36	13	I	OC.D.EXT		
						14	13	48	I	OC.D.INT	21	39	52	I	OC.D.INT		

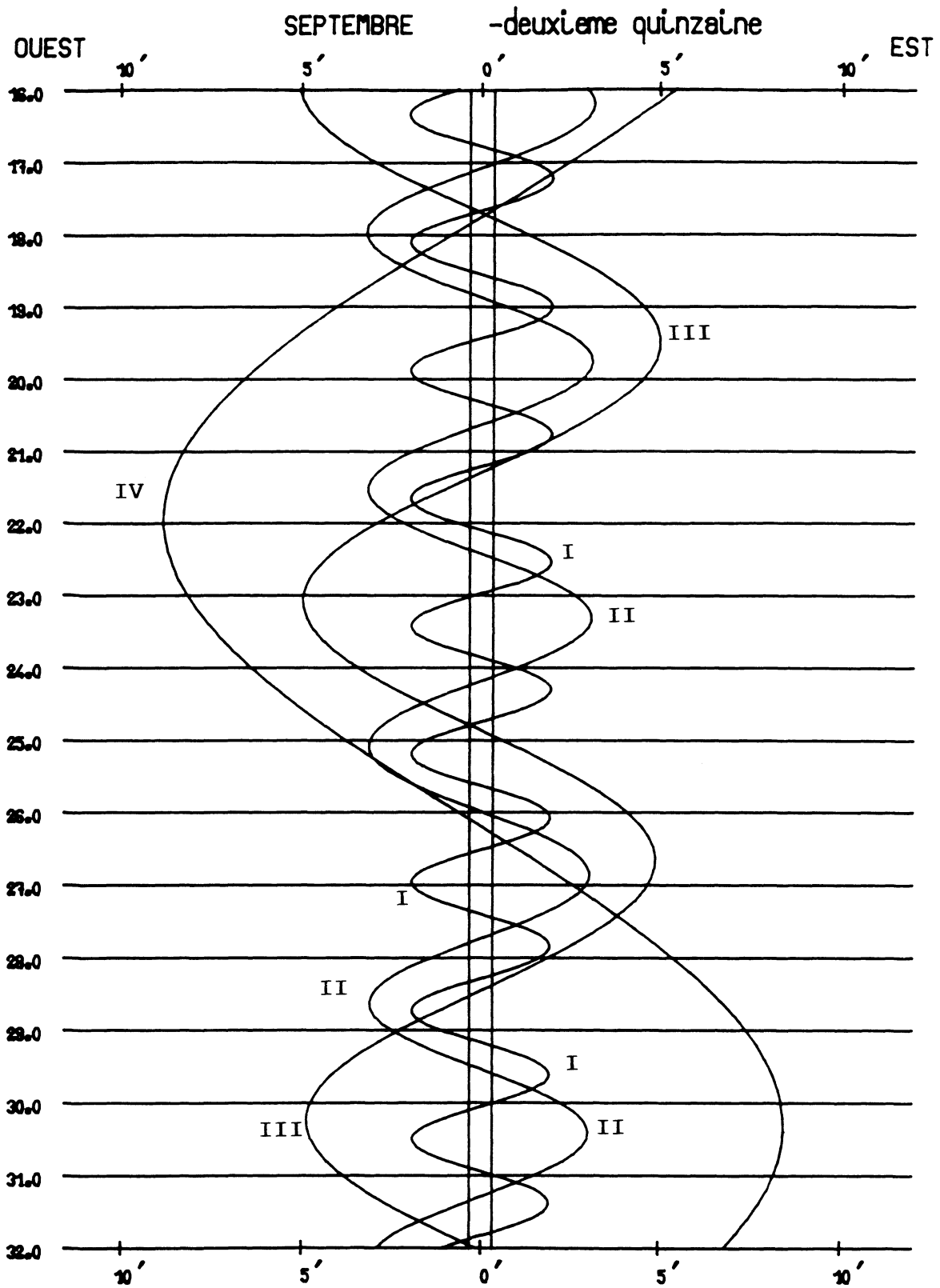

Dans le sens OUEST-EST, les satellites passent au-dela de Jupiter

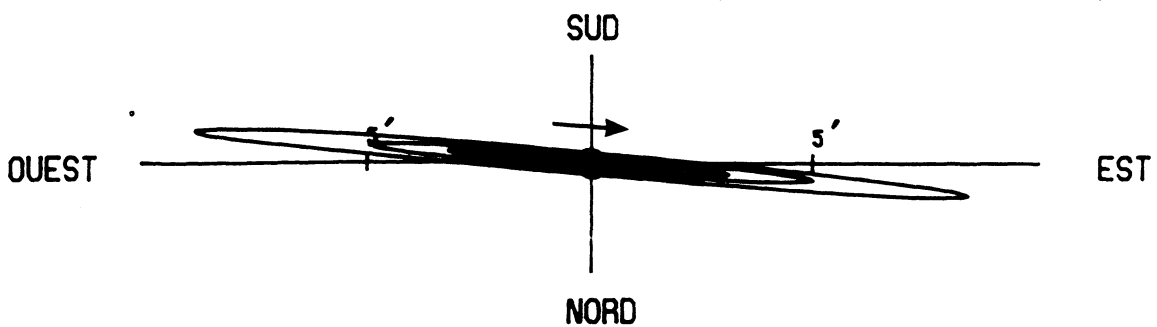

ORBITES APPARENTES

1996 - PHÉNOMÈNES DES SATELLITES GALILÉENS DE JUPITER
(Temps Terrestre)

PREMIÈRE QUINZAINE DE OCTOBRE																				
jour	h	m	s	SAT.	TYPE	jour	h	m	s	SAT.	TYPE	jour	h	m	s	SAT.	TYPE			
1	1	10	40	I	EC.F.INT	6	13	43	35	III	PA.D.INT	11	16	39	40	I	OM.D.EXT			
	1	14	18	I	EC.F.EXT		16	44	10	III	PA.F.INT		16	43	18	I	OM.D.INT			
	1	15	2	I	EC.F.PEN		16	53	39	III	PA.F.EXT		17	37	51	I	PA.F.INT			
	5	51	43	II	PA.D.EXT		18	47	33	III	OM.D.EXT		17	41	31	I	PA.F.EXT			
	5	55	37	II	PA.D.INT		18	56	37	III	OM.D.INT		18	55	24	I	OM.F.INT			
	8	26	29	II	OM.D.EXT		22	7	40	III	OM.F.INT		18	59	2	I	OM.F.EXT			
	8	30	21	II	OM.D.INT		22	16	43	III	OM.F.EXT									
	8	38	49	II	PA.F.INT															
	8	42	42	II	PA.F.EXT															
	11	17	6	II	OM.F.INT															
	11	20	57	II	OM.F.EXT															
	18	58	13	I	PA.D.EXT															
	19	1	53	I	PA.D.INT															
	20	15	26	I	OM.D.EXT															
	20	19	5	I	OM.D.INT															
	21	12	39	I	PA.F.INT															
	21	16	19	I	PA.F.EXT															
	22	31	8	I	OM.F.INT															
	22	34	46	I	OM.F.EXT															
	23	25	51	III	OC.D.EXT															
	23	35	18	III	OC.D.INT															
	2	2	37	38	III		OC.F.INT	7	2	25	9		I	PA.D.EXT	12	0	21	29	II	OM.D.EXT
		2	47	5	III		OC.F.EXT		2	28	49		I	PA.D.INT		0	25	21	II	OM.D.INT
4		40	3	III	EC.D.PEN	3	41		59	I	OM.D.EXT	0	36	6		II	PA.F.INT			
4		43	19	III	EC.D.EXT	3	45		37	I	OM.D.INT	0	40	0		II	PA.F.EXT			
4		52	26	III	EC.D.INT	4	39		36	I	PA.F.INT	3	12	39		II	OM.F.INT			
7		58	32	III	EC.F.INT	4	43		16	I	PA.F.EXT	3	16	30		II	OM.F.EXT			
8		7	40	III	EC.F.EXT	5	57		42	I	OM.F.INT	9	52	31		I	PA.D.EXT			
8		10	56	III	EC.F.PEN	6	1		20	I	OM.F.EXT	9	56	10		I	PA.D.INT			
16		5	3	I	OC.D.EXT	6	1		20	I	OM.F.EXT	11	8	27		I	OM.D.EXT			
16		8	42	I	OC.D.INT	23	31		52	I	OC.D.EXT	11	12	6		I	OM.D.INT			
19		39	31	I	EC.F.INT	23	35		32	I	OC.D.INT	12	7	1		I	PA.F.INT			
19		43	10	I	EC.F.EXT							12	10	41		I	PA.F.EXT			
19		43	54	I	EC.F.PEN							13	24	13		I	OM.F.INT			
												13	27	51		I	OM.F.EXT			
												17	38	36		III	PA.D.EXT			
												17	48	0		III	PA.D.INT			
												20	49	26		III	PA.F.INT			
										20	58	52	III	PA.F.EXT						
										22	47	29	III	OM.D.EXT						
										22	56	31	III	OM.D.INT						
3	0	57	32	II	OC.D.EXT	8	3	6	3	I	EC.F.INT	13	2	8	24	III	OM.F.INT			
	1	1	27	II	OC.D.INT		3	9	42	I	EC.F.EXT		2	17	25	III	OM.F.EXT			
	6	26	19	II	EC.F.INT		3	10	26	I	EC.F.PEN		6	59	17	I	OC.D.EXT			
	6	30	10	II	EC.F.EXT		8	28	57	II	PA.D.EXT		7	2	56	I	OC.D.INT			
	6	31	40	II	EC.F.PEN		8	32	50	II	PA.D.INT		10	32	39	I	EC.F.INT			
	13	27	11	I	PA.D.EXT		11	3	1	II	OM.D.EXT		10	36	17	I	EC.F.EXT			
	13	30	51	I	PA.D.INT		11	6	52	II	OM.D.INT		10	37	2	I	EC.F.PEN			
	14	44	19	I	OM.D.EXT		11	16	24	II	PA.F.INT		16	56	17	II	OC.D.EXT			
	14	47	58	I	OM.D.INT		11	20	18	II	PA.F.EXT		17	0	11	II	OC.D.INT			
	15	41	37	I	PA.F.INT		13	53	58	II	OM.F.INT		22	21	36	II	EC.F.INT			
	15	45	17	I	PA.F.EXT		13	57	49	II	OM.F.EXT		22	25	27	II	EC.F.EXT			
	17	0	1	I	OM.F.INT		20	54	12	I	PA.D.EXT		22	26	56	II	EC.F.PEN			
	17	3	40	I	OM.F.EXT		20	57	51	I	PA.D.INT									
							22	10	47	I	OM.D.EXT									
							22	14	25	I	OM.D.INT									
							23	8	40	I	PA.F.INT									
							23	12	19	I	PA.F.EXT									
4	10	33	54	I	OC.D.EXT	9	0	26	31	I	OM.F.INT	14	4	21	47	I	PA.D.EXT			
	10	37	34	I	OC.D.INT		0	30	9	I	OM.F.EXT		4	25	26	I	PA.D.INT			
	14	8	20	I	EC.F.INT		3	29	10	III	OC.D.EXT		5	37	18	I	OM.D.EXT			
	14	11	58	I	EC.F.EXT		3	38	35	III	OC.D.INT		5	40	56	I	OM.D.INT			
	14	12	43	I	EC.F.PEN		6	41	42	III	OC.F.INT		6	36	17	I	PA.F.INT			
	19	10	9	II	PA.D.EXT		6	51	7	III	OC.F.EXT		6	39	57	I	PA.F.EXT			
	19	14	2	II	PA.D.INT		8	44	13	III	EC.D.EXT		7	53	4	I	OM.F.INT			
	21	44	51	II	OM.D.EXT		8	53	19	III	EC.D.INT		7	56	42	I	OM.F.EXT			
	21	48	42	II	OM.D.INT		12	0	15	III	EC.F.INT									
	21	57	26	II	PA.F.INT		12	9	21	III	EC.F.EXT									
	22	1	19	II	PA.F.EXT		12	12	36	III	EC.F.PEN									
							18	0	57	I	OC.D.EXT									
							18	4	37	I	OC.D.INT									
					21	34	56	I	EC.F.INT											
					21	38	34	I	EC.F.EXT											
					21	39	19	I	EC.F.PEN											
5	0	35	39	II	OM.F.INT	10	3	36	9	II	OC.D.EXT	15	1	28	30	I	OC.D.EXT			
	0	39	30	II	OM.F.EXT		3	40	3	II	OC.D.INT		1	32	9	I	OC.D.INT			
	7	56	6	I	PA.D.EXT		9	3	9	II	OC.F.INT		5	1	28	I	EC.F.INT			
	7	59	46	I	PA.D.INT		9	3	9	II	OC.F.EXT		5	5	7	I	EC.F.EXT			
	9	13	7	I	OM.D.EXT		9	7	0	II	EC.F.EXT		5	5	51	I	EC.F.PEN			
	9	16	46	I	OM.D.INT		9	8	30	II	EC.F.PEN		11	8	13	II	PA.D.EXT			
	10	10	33	I	PA.F.INT		9	8	30	II	EC.F.PEN		11	12	6	II	PA.D.INT			
	10	14	13	I	PA.F.EXT		15	23	23	I	PA.D.EXT		13	39	45	II	OM.D.EXT			
	11	28	50	I	OM.F.INT		15	27	2	I	PA.D.INT		13	43	36	II	OM.D.INT			
	11	32	28	I	OM.F.EXT								13	56	6	II	PA.F.INT			
	13	34	9	III	PA.D.EXT								14	0	0	II	PA.F.EXT			

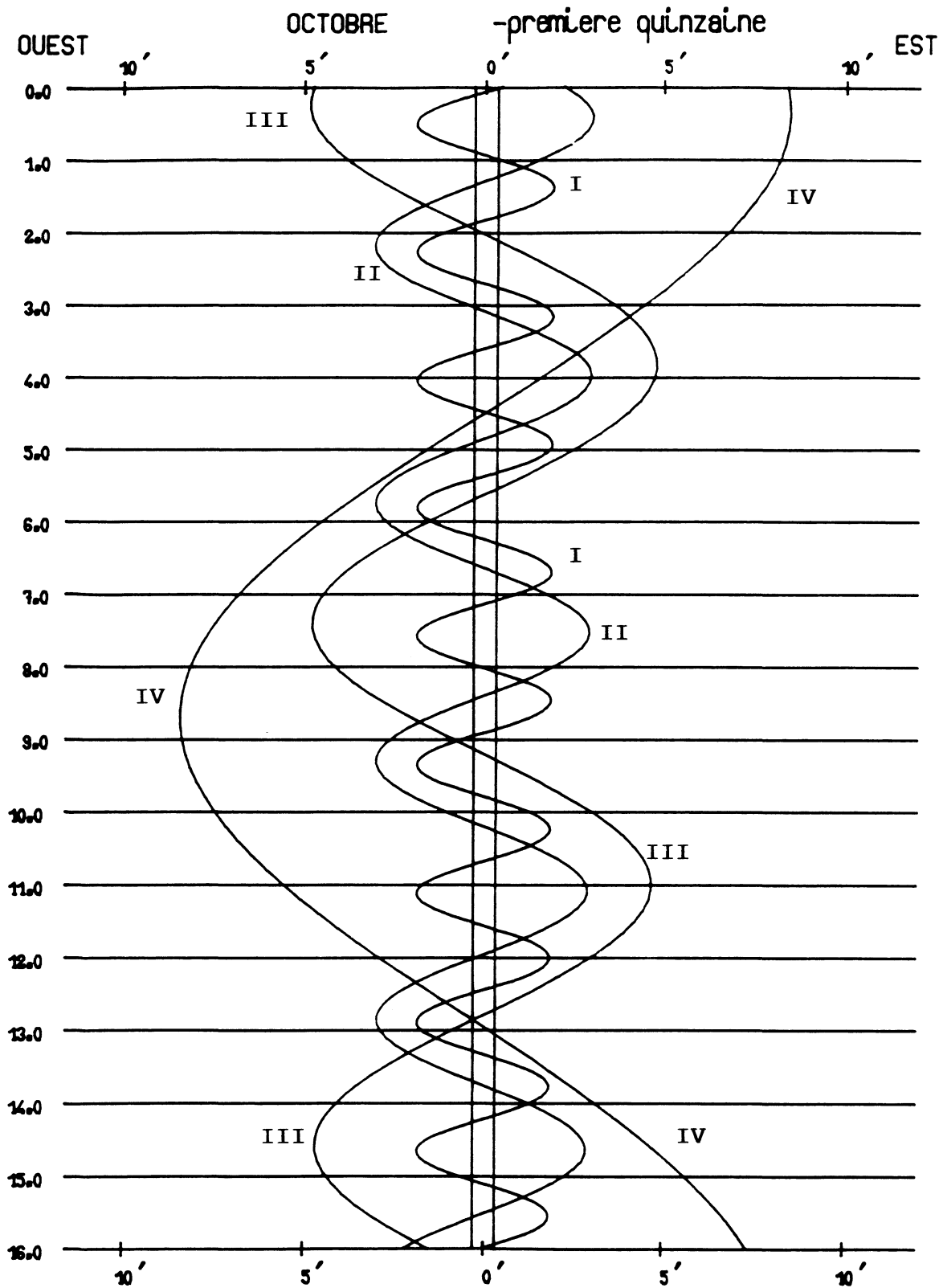

Dans le sens OUEST-EST, les satellites passent au-delà de Jupiter

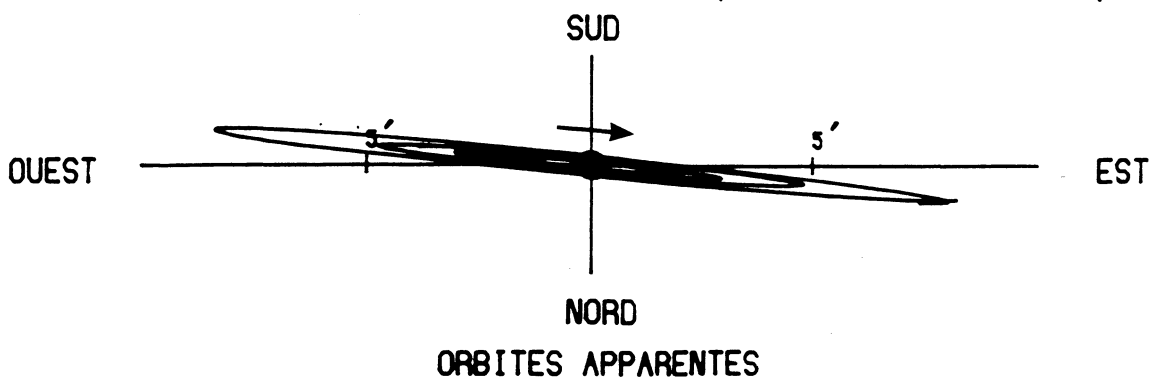

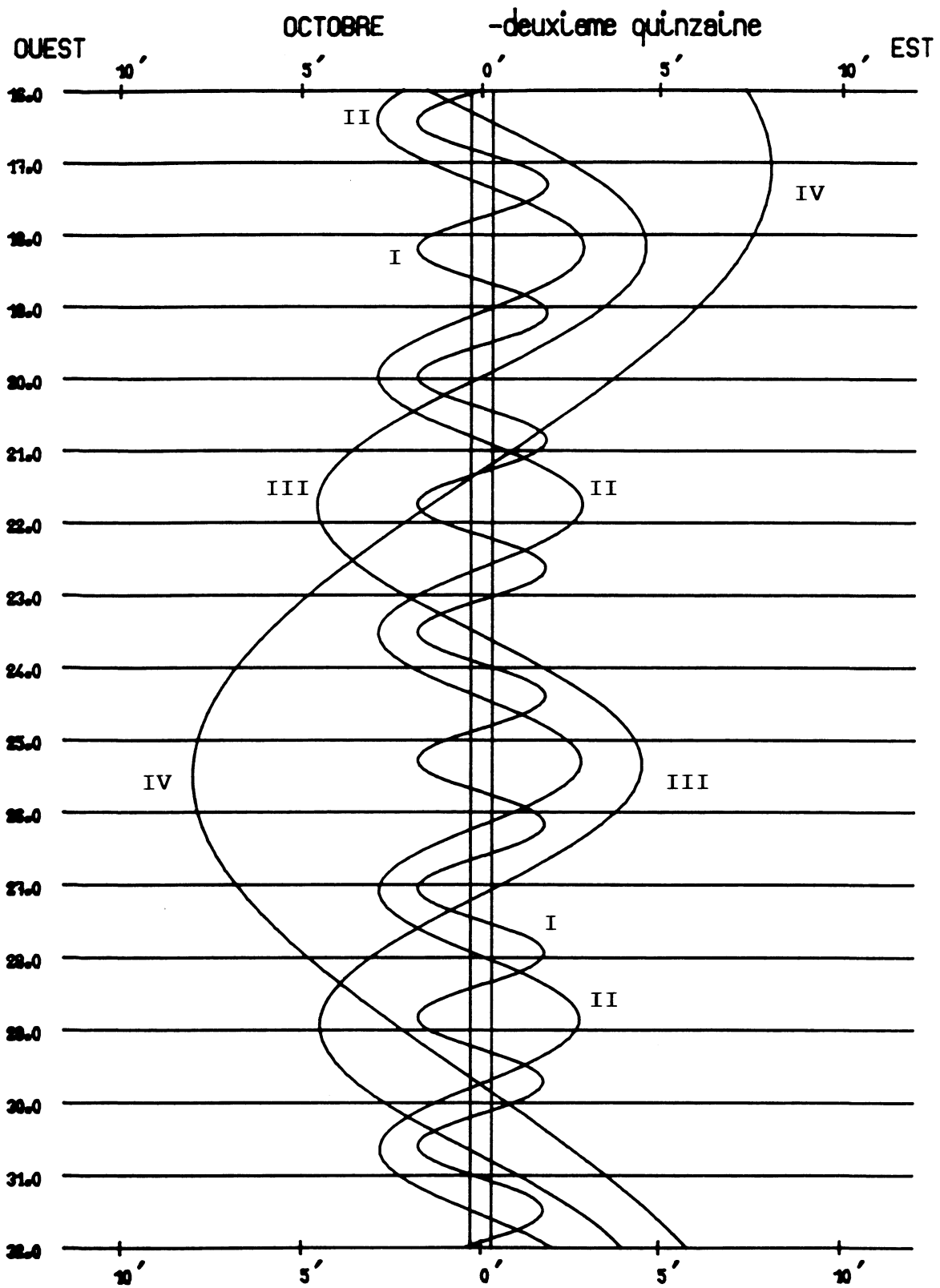

Dans le sens OUEST-EST, les satellites passent au-delà de Jupiter

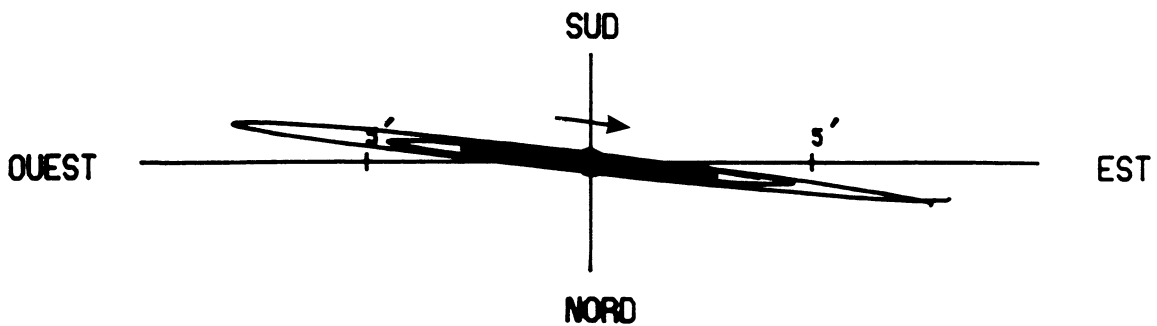

ORBITES APPARENTES

1996 - PHÉNOMÈNES DES SATELLITES GALILÉENS DE JUPITER
(Temps Terrestre)

PREMIÈRE QUINZAINE DE NOVEMBRE																		
jour	h	m	s	SAT.	TYPE	jour	h	m	s	SAT.	TYPE	jour	h	m	s	SAT.	TYPE	
1	0	41	24	I	OM.F.INT	5	55	19	I	OM.D.INT	11	3	48	35	II	OC.D.EXT		
	0	45	1	I	OM.F.EXT		7	0	48	I		PA.F.INT	3	52	26	II	OC.D.INT	
	18	23	44	I	OC.D.EXT		7	4	27	I		PA.F.EXT	8	46	50	II	EC.F.INT	
	18	27	23	I	OC.D.INT		8	7	47	I		OM.F.INT	8	50	39	II	EC.F.EXT	
	21	50	3	I	EC.F.INT		8	11	25	I		OM.F.EXT	8	52	7	II	EC.F.PEN	
	21	53	42	I	EC.F.EXT		20	15	30	III		OC.D.EXT	12	15	29	I	PA.D.EXT	
21	54	26	I	EC.F.PEN	20	24	45	III	OC.D.INT	12	19	7	I	PA.D.INT				
2	5	54	22	II	PA.D.EXT	23	31	32	III	OC.F.INT	13	18	0	I	OM.D.EXT			
	5	58	15	II	PA.D.INT	23	40	48	III	OC.F.EXT	13	21	38	I	OM.D.INT			
	8	12	24	II	OM.D.EXT	7	0	42	0	III	EC.D.PEN	14	30	30	I	PA.F.INT		
	8	16	15	II	OM.D.INT		0	45	13	III	EC.D.EXT	14	34	9	I	PA.F.EXT		
	8	43	36	II	PA.F.INT		0	54	9	III	EC.D.INT	15	34	12	I	OM.F.INT		
	8	47	29	II	PA.F.EXT		1	53	15	I	OC.D.EXT	15	37	50	I	OM.F.EXT		
	11	4	48	II	OM.F.INT		1	56	55	I	OC.D.INT	12	9	23	5	I	OC.D.EXT	
	11	8	39	II	OM.F.EXT		4	4	14	III	EC.F.INT		9	26	44	I	OC.D.INT	
	15	46	21	I	PA.D.EXT		4	13	10	III	EC.F.EXT		12	43	14	I	EC.F.INT	
	15	50	0	I	PA.D.INT		4	16	23	III	EC.F.PEN		12	46	52	I	EC.F.EXT	
	16	54	9	I	OM.D.EXT		5	16	41	I	EC.F.INT		12	47	37	I	EC.F.PEN	
	16	57	46	I	OM.D.INT		5	20	20	I	EC.F.EXT		22	2	30	II	PA.D.EXT	
	18	1	12	I	PA.F.INT		5	21	4	I	EC.F.PEN		22	6	24	II	PA.D.INT	
	18	4	51	I	PA.F.EXT		14	25	53	II	OC.D.EXT		13	0	7	59	II	OM.D.EXT
19	10	11	I	OM.F.INT	14		29	45	II	OC.D.INT	0			11	50	II	OM.D.INT	
19	13	49	I	OM.F.EXT	19		28	47	II	EC.F.INT	0			52	35	II	PA.F.INT	
3	6	13	49	III	PA.D.EXT	19	32	36	II	EC.F.EXT	0			56	28	II	PA.F.EXT	
	6	23	6	III	PA.D.INT	19	34	4	II	EC.F.PEN	3			1	0	II	OM.F.INT	
	9	27	46	III	PA.F.INT	23	15	45	I	PA.D.EXT	3			4	51	II	OM.F.EXT	
	9	37	5	III	PA.F.EXT	23	19	24	I	PA.D.INT	6			45	22	I	PA.D.EXT	
	10	48	50	III	OM.D.EXT	8	0	20	30	I	OM.D.EXT	6		49	1	I	PA.D.INT	
	10	57	46	III	OM.D.INT		0	24	7	I	OM.D.INT	7		46	44	I	OM.D.EXT	
	12	53	34	I	OC.D.EXT		1	30	42	I	PA.F.INT	7		50	22	I	OM.D.INT	
	12	57	13	I	OC.D.INT		1	34	21	I	PA.F.EXT	9		0	27	I	PA.F.INT	
	14	12	21	III	OM.F.INT		2	36	38	I	OM.F.INT	9		4	6	I	PA.F.EXT	
	14	21	17	III	OM.F.EXT		2	40	15	I	OM.F.EXT	10		2	59	I	OM.F.INT	
	16	18	58	I	EC.F.INT		20	23	7	I	OC.D.EXT	10		6	36	I	OM.F.EXT	
	16	22	37	I	EC.F.EXT		20	26	47	I	OC.D.INT	14	0	34	6	III	OC.D.EXT	
	16	23	21	I	EC.F.PEN		23	45	30	I	EC.F.INT		0	43	18	III	OC.D.INT	
	4	1	3	37	II		OC.D.EXT	23	49	8	I		EC.F.EXT	3	51	11	III	OC.F.INT
1		7	29	II	OC.D.INT		23	49	52	I	EC.F.PEN		3	53	7	I	OC.D.EXT	
6		10	45	II	EC.F.INT		9	8	39	36	II		PA.D.EXT	3	56	47	I	OC.D.INT
6		14	35	II	EC.F.EXT			8	43	29	II		PA.D.INT	4	0	24	III	OC.F.EXT
6		16	3	II	EC.F.PEN			10	49	37	II		OM.D.EXT	4	42	3	III	EC.D.PEN
10		16	7	I	PA.D.EXT	10		53	28	II	OM.D.INT		4	45	15	III	EC.D.EXT	
10		19	46	I	PA.D.INT	11		29	24	II	PA.F.INT		4	54	9	III	EC.D.INT	
11		22	56	I	OM.D.EXT	11		33	17	II	PA.F.EXT		7	12	7	I	EC.F.INT	
11		26	34	I	OM.D.INT	13		42	27	II	OM.F.INT		7	15	45	I	EC.F.EXT	
12		31	0	I	PA.F.INT	13		46	18	II	OM.F.EXT		7	16	30	I	EC.F.PEN	
12		34	39	I	PA.F.EXT	17		45	35	I	PA.D.EXT		8	5	2	III	EC.F.INT	
13		39	0	I	OM.F.INT	17		49	13	I	PA.D.INT		8	13	56	III	EC.F.EXT	
13		42	38	I	OM.F.EXT	18		49	14	I	OM.D.EXT	8	17	8	III	EC.F.PEN		
5		7	23	22	I	OC.D.EXT		18	52	52	I	OM.D.INT	17	11	22	II	OC.D.EXT	
	7	27	1	I	OC.D.INT	20		0	34	I	PA.F.INT	17	15	13	II	OC.D.INT		
	10	47	48	I	EC.F.INT	20		4	13	I	PA.F.EXT	22	4	45	II	EC.F.INT		
	10	51	26	I	EC.F.EXT	21	5	24	I	OM.F.INT	22	8	34	II	EC.F.EXT			
	10	52	11	I	EC.F.PEN	21	9	2	I	OM.F.EXT	22	10	2	II	EC.F.PEN			
	19	16	36	II	PA.D.EXT	10	10	31	28	III	PA.D.EXT	15	1	15	22	I	PA.D.EXT	
	19	20	29	II	PA.D.INT		10	40	43	III	PA.D.INT		1	19	0	I	PA.D.INT	
	21	30	44	II	OM.D.EXT		13	46	37	III	PA.F.INT		2	15	32	I	OM.D.EXT	
	21	34	36	II	OM.D.INT		13	55	53	III	PA.F.EXT		2	19	9	I	OM.D.INT	
	22	6	5	II	PA.F.INT		14	49	10	III	OM.D.EXT		3	30	29	I	PA.F.INT	
	22	9	58	II	PA.F.EXT		14	53	7	I	OC.D.EXT		3	34	7	I	PA.F.EXT	
	6	0	23	20	II		OM.F.INT	14	56	47	I		OC.D.INT	4	31	48	I	OM.F.INT
		0	27	10	II		OM.F.EXT	14	58	4	III		OM.D.INT	4	35	25	I	OM.F.EXT
		4	45	53	I		PA.D.EXT	18	13	34	III		OM.F.INT	22	23	8	I	OC.D.EXT
4		49	32	I	PA.D.INT		18	14	24	I	EC.F.INT		22	26	47	I	OC.D.INT	
4		49	32	I	PA.D.INT		18	18	3	I	EC.F.EXT							
5		51	41	I	OM.D.EXT		18	18	47	I	EC.F.PEN							

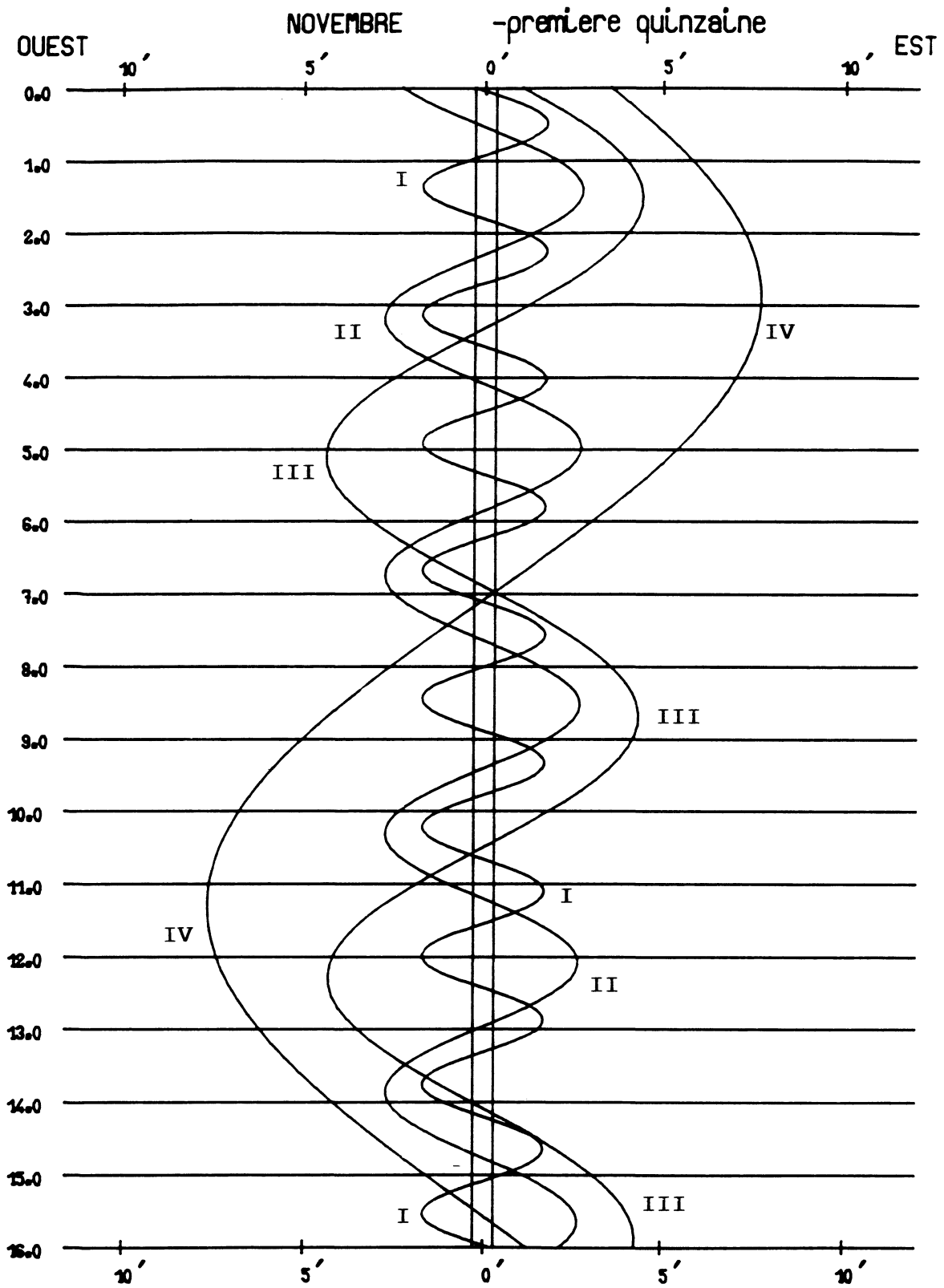

Dans le sens OUEST-EST ,les satellites passent au-dela de Jupiter

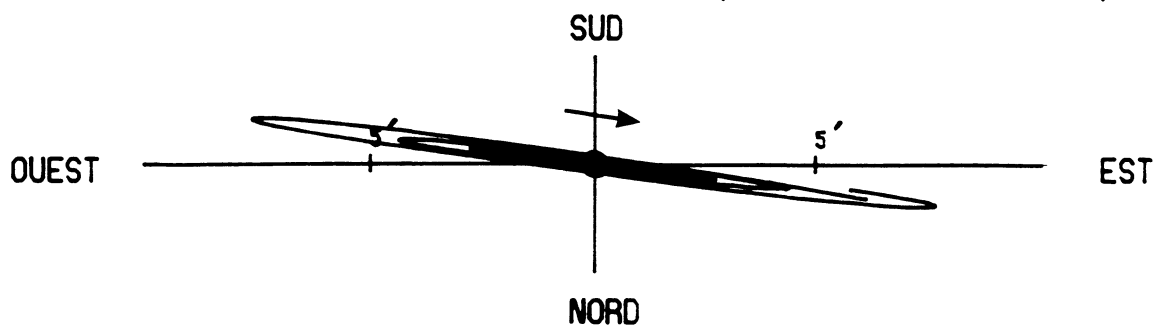

ORBITES APPARENTES

1996 - PHÉNOMÈNES DES SATELLITES GALILÉENS DE JUPITER
(Temps Terrestre)

DEUXIÈME QUINZAINE DE NOVEMBRE																	
jour	h	m	s	SAT.	TYPE	jour	h	m	s	SAT.	TYPE	jour	h	m	s	SAT.	TYPE
16	1	40	55	I	EC.F.INT	5	53	33	I	OC.D.EXT	18	31	0	I	PA.F.INT		
	1	44	33	I	EC.F.EXT	5	57	12	I	OC.D.INT	18	34	38	I	PA.F.EXT		
	1	45	17	I	EC.F.PEN	8	13	25	III	OC.F.INT	19	24	23	I	OM.F.INT		
	11	26	15	II	PA.D.EXT	8	22	34	III	OC.F.EXT	19	28	0	I	OM.F.EXT		
	11	30	8	II	PA.D.INT	8	42	12	III	EC.D.PEN							
	13	26	58	II	OM.D.EXT	8	45	24	III	EC.D.EXT	26	13	24	10	I	OC.D.EXT	
	13	30	49	II	OM.D.INT	8	54	16	III	EC.D.INT	13	27	49	I	OC.D.INT		
	14	16	39	II	PA.F.INT	9	7	31	I	EC.F.INT	16	34	0	I	EC.F.INT		
	14	20	32	II	PA.F.EXT	9	11	9	I	EC.F.EXT	16	37	38	I	EC.F.EXT		
	16	20	14	II	OM.F.INT	9	11	54	I	EC.F.PEN	16	38	23	I	EC.F.PEN		
	16	24	5	II	OM.F.EXT	12	5	55	III	EC.F.INT							
	19	45	19	I	PA.D.EXT	12	14	47	III	EC.F.EXT	27	3	38	14	II	PA.D.EXT	
	19	48	58	I	PA.D.INT	12	17	59	III	EC.F.PEN	3	42	7	II	PA.D.INT		
	20	44	15	I	OM.D.EXT	19	57	44	II	OC.D.EXT	5	22	48	II	OM.D.EXT		
	20	47	52	I	OM.D.INT	20	1	35	II	OC.D.INT	5	26	39	II	OM.D.INT		
	22	0	29	I	PA.F.INT						6	29	30	II	PA.F.INT		
	22	4	7	I	PA.F.EXT	22	0	40	32	II	EC.F.INT	6	33	23	II	PA.F.EXT	
	23	0	34	I	OM.F.INT	0	44	20	II	EC.F.EXT	8	16	42	II	OM.F.INT		
	23	4	11	I	OM.F.EXT	0	45	48	II	EC.F.PEN	8	20	32	II	OM.F.EXT		
						3	15	27	I	PA.D.EXT	10	45	44	I	PA.D.EXT		
17	14	51	57	III	PA.D.EXT	3	19	5	I	PA.D.INT	10	49	22	I	PA.D.INT		
	15	1	9	III	PA.D.INT	4	10	29	I	OM.D.EXT	11	36	36	I	OM.D.EXT		
	16	53	16	I	OC.D.EXT	4	14	6	I	OM.D.INT	11	40	13	I	OM.D.INT		
	16	56	56	I	OC.D.INT	5	30	44	I	PA.F.INT	13	1	9	I	PA.F.INT		
	18	8	19	III	PA.F.INT	5	34	23	I	PA.F.EXT	13	4	48	I	PA.F.EXT		
	18	17	32	III	PA.F.EXT	6	26	53	I	OM.F.INT	13	53	7	I	OM.F.INT		
	18	49	44	III	OM.D.EXT	6	30	30	I	OM.F.EXT	13	56	44	I	OM.F.EXT		
	18	58	35	III	OM.D.INT												
	20	9	49	I	EC.F.INT	23	0	23	41	I	OC.D.EXT	28	7	54	28	I	OC.D.EXT
	20	13	27	I	EC.F.EXT	0	27	20	I	OC.D.INT	7	58	7	I	OC.D.INT		
	20	14	12	I	EC.F.PEN	3	36	18	I	EC.F.INT	9	19	10	III	OC.D.EXT		
	22	14	58	III	OM.F.INT	3	39	56	I	EC.F.EXT	9	28	16	III	OC.D.INT		
	22	23	49	III	OM.F.EXT	3	40	41	I	EC.F.PEN	11	2	53	I	EC.F.INT		
						14	14	9	II	PA.D.EXT	11	6	31	I	EC.F.EXT		
18	6	34	30	II	OC.D.EXT	14	18	2	II	PA.D.INT	11	7	16	I	EC.F.PEN		
	6	38	21	II	OC.D.INT	16	4	23	II	OM.D.EXT	12	38	32	III	OC.F.INT		
	11	22	41	II	EC.F.INT	16	8	14	II	OM.D.INT	12	43	8	III	EC.D.PEN		
	11	26	29	II	EC.F.EXT	17	5	9	II	PA.F.INT	12	46	20	III	EC.D.EXT		
	11	27	58	II	EC.F.PEN	17	9	2	II	PA.F.EXT	12	47	38	III	OC.F.EXT		
	14	15	20	I	PA.D.EXT	18	58	6	II	OM.F.INT	12	55	10	III	EC.D.INT		
	14	18	59	I	PA.D.INT	19	1	56	II	OM.F.EXT	16	7	34	III	EC.F.INT		
	15	13	0	I	OM.D.EXT	21	45	30	I	PA.D.EXT	16	16	24	III	EC.F.EXT		
	15	16	37	I	OM.D.INT	21	49	9	I	PA.D.INT	16	19	35	III	EC.F.PEN		
	16	30	32	I	PA.F.INT	22	39	11	I	OM.D.EXT	22	44	55	II	OC.D.EXT		
	16	34	11	I	PA.F.EXT	22	42	48	I	OM.D.INT	22	48	46	II	OC.D.INT		
	17	29	20	I	OM.F.INT												
	17	32	58	I	OM.F.EXT	24	0	0	51	I	PA.F.INT	29	3	16	10	II	EC.F.INT
19	11	23	22	I	OC.D.EXT	0	4	29	I	PA.F.EXT	3	19	58	II	EC.F.EXT		
	11	27	1	I	OC.D.INT	0	55	38	I	OM.F.INT	3	21	26	II	EC.F.PEN		
	14	38	38	I	EC.F.INT	0	59	15	I	OM.F.EXT	5	15	55	I	PA.D.EXT		
	14	42	16	I	EC.F.EXT	18	53	57	I	OC.D.EXT	5	19	33	I	PA.D.INT		
	14	43	1	I	EC.F.PEN	18	57	36	I	OC.D.INT	6	5	20	I	OM.D.EXT		
						19	13	52	III	PA.D.EXT	6	8	57	I	OM.D.INT		
20	0	49	48	II	PA.D.EXT	19	23	0	III	PA.D.INT	7	31	23	I	PA.F.INT		
	0	53	41	II	PA.D.INT	22	5	12	I	EC.F.INT	7	35	1	I	PA.F.EXT		
	2	45	22	II	OM.D.EXT	22	8	50	I	EC.F.EXT	8	21	53	I	OM.F.INT		
	2	49	13	II	OM.D.INT	22	9	35	I	EC.F.PEN	8	25	30	I	OM.F.EXT		
	3	40	28	II	PA.F.INT	22	31	30	III	PA.F.INT							
	3	44	21	II	PA.F.EXT	22	40	39	III	PA.F.EXT	30	2	24	42	I	OC.D.EXT	
	5	38	50	II	OM.F.INT	22	49	33	III	OM.D.EXT	2	28	21	I	OC.D.INT		
	5	42	41	II	OM.F.EXT	22	58	22	III	OM.D.INT	5	31	39	I	EC.F.INT		
	8	45	21	I	PA.D.EXT						5	35	17	I	EC.F.EXT		
	8	48	59	I	PA.D.INT	25	2	15	37	III	OM.F.INT	5	36	2	I	EC.F.PEN	
	9	41	43	I	OM.D.EXT	2	24	26	III	OM.F.EXT	17	3	10	II	PA.D.EXT		
	9	45	20	I	OM.D.INT	9	21	17	II	OC.D.EXT	17	7	3	II	PA.D.INT		
	11	0	36	I	PA.F.INT	9	25	8	II	OC.D.INT	18	41	53	II	OM.D.EXT		
	11	4	14	I	PA.F.EXT	13	58	23	II	EC.F.INT	18	45	44	II	OM.D.INT		
	11	58	5	I	OM.F.INT	14	2	11	II	EC.F.EXT	19	54	45	II	PA.F.INT		
	12	1	43	I	OM.F.EXT	14	3	39	II	EC.F.PEN	19	58	38	II	PA.F.EXT		
21	4	55	12	III	OC.D.EXT	16	15	37	I	PA.D.EXT	21	36	0	II	OM.F.INT		
	5	4	22	III	OC.D.INT	16	19	15	I	PA.D.INT	21	39	51	II	OM.F.EXT		
						17	7	54	I	OM.D.EXT	23	46	4	I	PA.D.EXT		
						17	11	31	I	OM.D.INT	23	49	42	I	PA.D.INT		

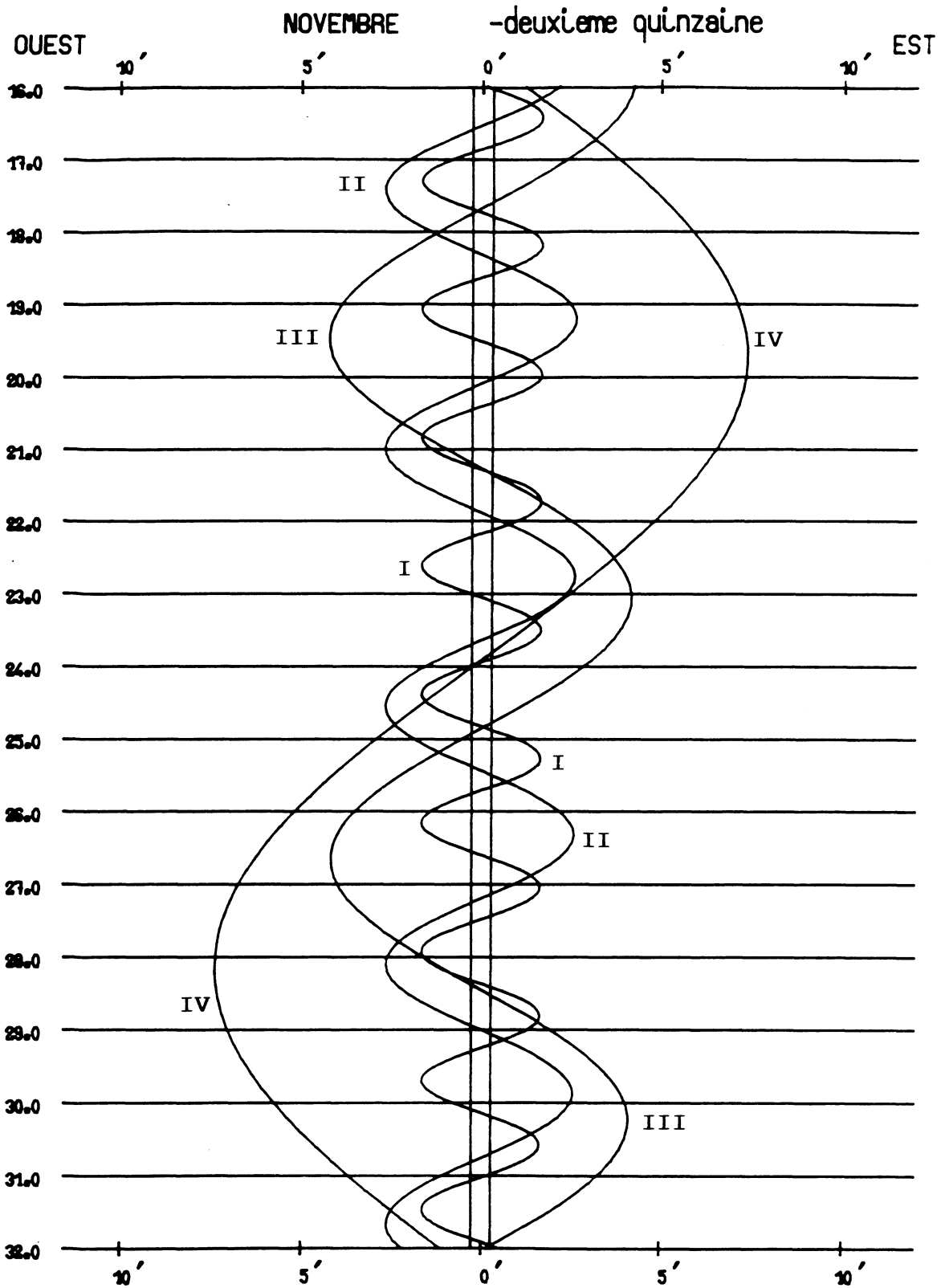

Dans le sens OUEST-EST, les satellites passent au-delà de Jupiter

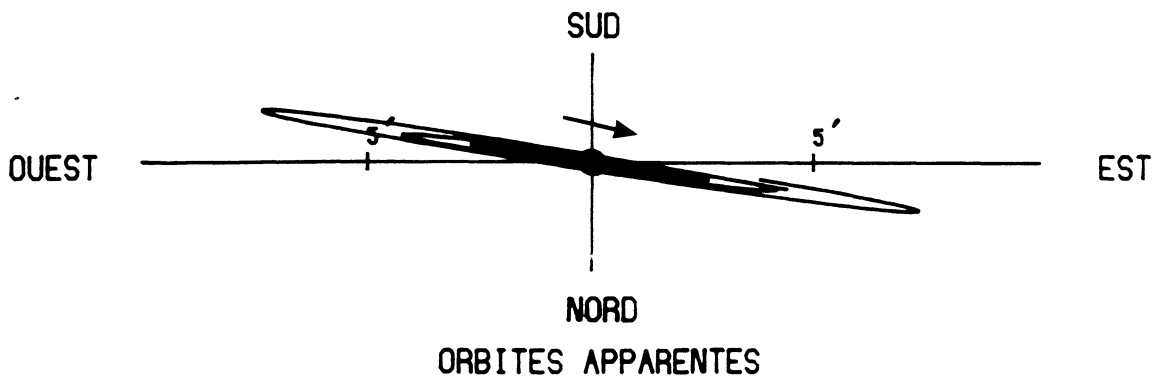

1996 - PHÉNOMÈNES DES SATELLITES GALILÉENS DE JUPITER
(Temps Terrestre)

PREMIÈRE QUINZAINE DE DÉCEMBRE

jour	h	m	s	SAT.	TYPE	jour	h	m	s	SAT.	TYPE	jour	h	m	s	SAT.	TYPE
1	0	34	1	I	OM.D.EXT	6	1	32	43	II	OC.D.EXT	20	29	0	I	EC.F.PEN	
	0	37	38	I	OM.D.INT		1	36	33	II	OC.D.INT						
	2	1	35	I	PA.F.INT		5	51	37	II	EC.F.INT	11	9	18	11	II	PA.D.EXT
	2	5	13	I	PA.F.EXT		5	55	24	II	EC.F.EXT		9	22	4	II	PA.D.INT
	2	50	37	I	OM.F.INT		5	56	52	II	EC.F.PEN		10	37	55	II	OM.D.EXT
	2	54	14	I	OM.F.EXT		7	16	43	I	PA.D.EXT		10	41	46	II	OM.D.INT
	20	55	5	I	OC.D.EXT		7	20	21	I	PA.D.INT		12	10	35	II	PA.F.INT
	20	58	44	I	OC.D.INT		8	0	6	I	OM.D.EXT		12	14	28	II	PA.F.EXT
	23	37	30	III	PA.D.EXT		8	3	43	I	OM.D.INT		13	32	35	II	OM.F.INT
	23	46	35	III	PA.D.INT		9	32	22	I	PA.F.INT		13	36	26	II	OM.F.EXT
							9	36	0	I	PA.F.EXT		14	47	28	I	PA.D.EXT
2	0	0	33	I	EC.F.INT		10	16	48	I	OM.F.INT		14	51	6	I	PA.D.INT
	0	4	11	I	EC.F.EXT		10	20	25	I	OM.F.EXT		15	26	5	I	OM.D.EXT
	0	4	55	I	EC.F.PEN								15	29	42	I	OM.D.INT
	2	49	11	III	OM.D.EXT	7	4	26	7	I	OC.D.EXT		17	3	16	I	PA.F.INT
	2	56	28	III	PA.F.INT		4	29	46	I	OC.D.INT		17	6	54	I	PA.F.EXT
	2	57	59	III	OM.D.INT		7	26	58	I	EC.F.INT		17	42	53	I	OM.F.INT
	3	5	34	III	PA.F.EXT		7	30	36	I	EC.F.EXT		17	46	30	I	OM.F.EXT
	6	16	6	III	OM.F.INT		7	31	21	I	EC.F.PEN						
	6	24	54	III	OM.F.EXT		19	53	12	II	PA.D.EXT	12	11	57	28	I	OC.D.EXT
	12	8	46	II	OC.D.EXT		19	57	5	II	PA.D.INT		12	1	7	I	OC.D.INT
	12	12	36	II	OC.D.INT		21	19	29	II	OM.D.EXT		14	53	29	I	EC.F.INT
	16	33	54	II	EC.F.INT		21	23	20	II	OM.D.INT		14	57	7	I	EC.F.EXT
	16	37	42	II	EC.F.EXT		22	45	21	II	PA.F.INT		14	57	51	I	EC.F.PEN
	16	39	10	II	EC.F.PEN		22	49	14	II	PA.F.EXT		18	11	35	III	OC.D.EXT
	18	16	16	I	PA.D.EXT								18	20	34	III	OC.D.INT
	18	19	54	I	PA.D.INT	8	0	14	0	II	OM.F.INT						
	19	2	43	I	OM.D.EXT		0	17	51	II	OM.F.EXT	13	0	9	50	III	EC.F.INT
	19	6	20	I	OM.D.INT		1	46	57	I	PA.D.EXT		0	18	36	III	EC.F.EXT
	20	31	50	I	PA.F.INT		1	50	35	I	PA.D.INT		0	21	46	III	EC.F.PEN
	20	35	28	I	PA.F.EXT		2	28	46	I	OM.D.EXT		4	21	5	II	OC.D.EXT
	21	19	21	I	OM.F.INT		2	32	23	I	OM.D.INT		4	24	54	II	OC.D.INT
	21	22	58	I	OM.F.EXT		4	2	39	I	PA.F.INT		8	26	55	II	EC.F.INT
							4	6	17	I	PA.F.EXT		8	30	43	II	EC.F.EXT
3	15	25	23	I	OC.D.EXT		4	45	30	I	OM.F.INT		8	32	10	II	EC.F.PEN
	15	29	2	I	OC.D.INT		4	49	7	I	OM.F.EXT		9	17	48	I	PA.D.EXT
	18	29	20	I	EC.F.INT		22	56	35	I	OC.D.EXT		9	21	25	I	PA.D.INT
	18	32	58	I	EC.F.EXT		23	0	14	I	OC.D.INT		9	54	46	I	OM.D.EXT
	18	33	43	I	EC.F.PEN								9	58	23	I	OM.D.INT
						9	1	55	50	I	EC.F.INT		11	33	38	I	PA.F.INT
4	6	27	46	II	PA.D.EXT		1	59	28	I	EC.F.EXT		11	37	15	I	PA.F.EXT
	6	31	39	II	PA.D.INT		2	0	13	I	EC.F.PEN		12	11	36	I	OM.F.INT
	8	0	21	II	OM.D.EXT		4	2	53	III	PA.D.EXT		12	15	13	I	OM.F.EXT
	8	4	12	II	OM.D.INT		4	11	55	III	PA.D.INT						
	9	19	36	II	PA.F.INT		6	48	56	III	OM.D.EXT	14	6	27	53	I	OC.D.EXT
	9	23	29	II	PA.F.EXT		6	57	42	III	OM.D.INT		6	31	31	I	OC.D.INT
	10	54	38	II	OM.F.INT		7	23	14	III	PA.F.INT		9	22	13	I	EC.F.INT
	10	58	29	II	OM.F.EXT		7	32	17	III	PA.F.EXT		9	25	51	I	EC.F.EXT
	12	46	27	I	PA.D.EXT		10	16	43	III	OM.F.INT		9	26	36	I	EC.F.PEN
	12	50	5	I	PA.D.INT		10	25	29	III	OM.F.EXT		22	44	4	II	PA.D.EXT
	13	31	23	I	OM.D.EXT		14	56	50	II	OC.D.EXT		22	47	57	II	PA.D.INT
	13	35	0	I	OM.D.INT		15	0	39	II	OC.D.INT		23	57	6	II	OM.D.EXT
	15	2	4	I	PA.F.INT		19	9	15	II	EC.F.INT						
	15	5	42	I	PA.F.EXT		19	13	3	II	EC.F.EXT	15	0	0	57	II	OM.D.INT
	15	48	3	I	OM.F.INT		19	14	31	II	EC.F.PEN		1	36	45	II	PA.F.INT
	15	51	40	I	OM.F.EXT		20	17	13	I	PA.D.EXT		1	40	38	II	PA.F.EXT
							20	20	51	I	PA.D.INT		2	51	58	II	OM.F.INT
5	9	55	47	I	OC.D.EXT		20	57	26	I	OM.D.EXT		2	55	49	II	OM.F.EXT
	9	59	26	I	OC.D.INT		21	1	3	I	OM.D.INT		3	48	5	I	PA.D.EXT
	12	58	12	I	EC.F.INT		22	32	58	I	PA.F.INT		3	51	43	I	PA.D.INT
	13	1	50	I	EC.F.EXT		22	36	35	I	PA.F.EXT		4	23	25	I	OM.D.EXT
	13	2	35	I	EC.F.PEN		23	14	12	I	OM.F.INT		4	27	1	I	OM.D.INT
	13	44	24	III	OC.D.EXT		23	17	49	I	OM.F.EXT		6	3	58	I	PA.F.INT
	13	53	27	III	OC.D.INT								6	7	36	I	PA.F.EXT
	20	8	34	III	EC.F.INT	10	17	26	59	I	OC.D.EXT		6	40	17	I	OM.F.INT
	20	17	22	III	EC.F.EXT		17	30	38	I	OC.D.INT		6	43	53	I	OM.F.EXT
	20	20	33	III	EC.F.PEN		20	24	37	I	EC.F.INT						
							20	28	15	I	EC.F.EXT						

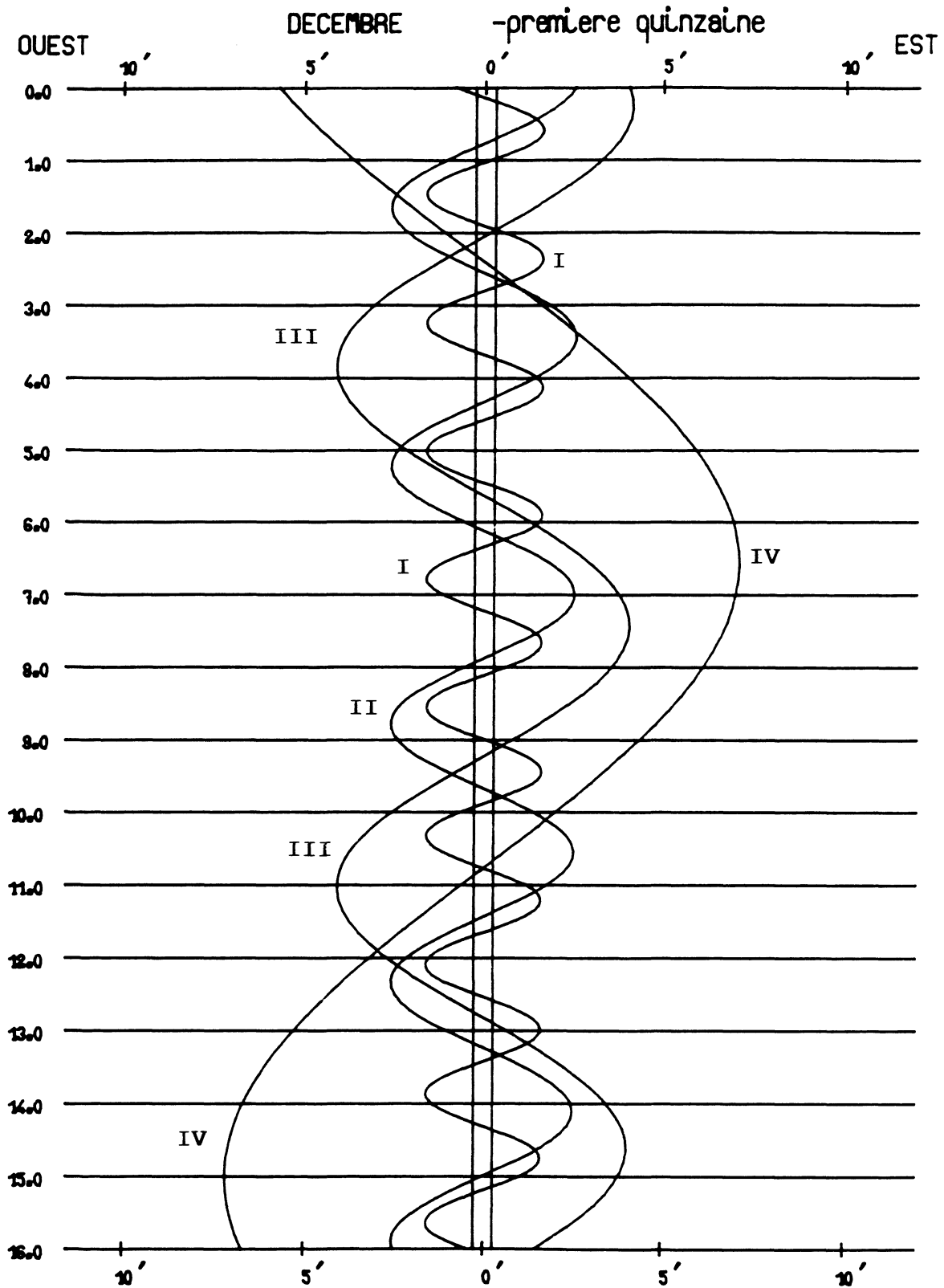

Dans le sens OUEST-EST, les satellites passent au-delà de Jupiter

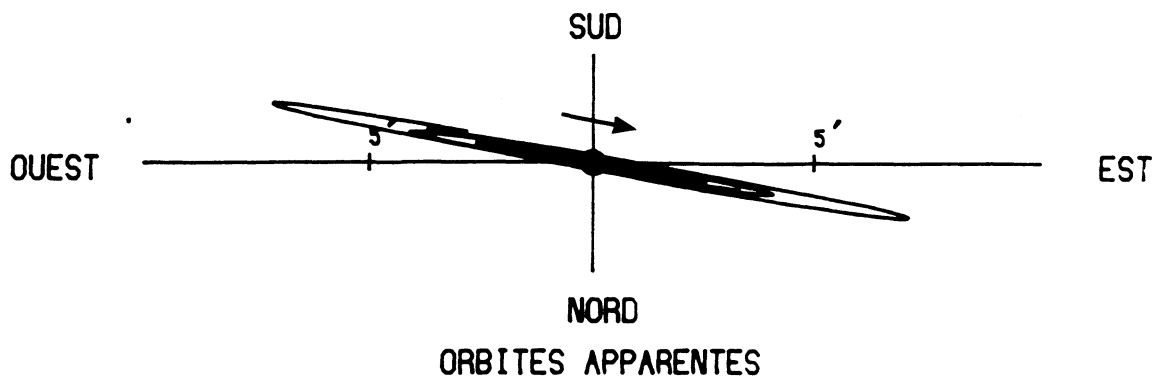

1996 - PHÉNOMÈNES DES SATELLITES GALILÉENS DE JUPITER
(Temps Terrestre)

DEUXIÈME QUINZAINE DE DÉCEMBRE

jour	h	m	s	SAT.	TYPE	jour	h	m	s	SAT.	TYPE	jour	h	m	s	SAT.	TYPE
16	0	58	25	I	OC.D.EXT	1	39	33	II	PA.D.INT	13	40	48	II	EC.F.EXT		
	1	2	4	I	OC.D.INT	2	34	48	II	OM.D.EXT	13	42	16	II	EC.F.PEN		
	3	51	5	I	EC.F.INT	2	38	39	II	OM.D.INT	13	43	49	I	OM.D.EXT		
	3	54	43	I	EC.F.EXT	4	28	51	II	PA.F.INT	13	47	25	I	OM.D.INT		
	3	55	28	I	EC.F.PEN	4	32	44	II	PA.F.EXT	15	36	41	I	PA.F.INT		
	8	29	50	III	PA.D.EXT	5	29	59	II	OM.F.INT	15	40	18	I	PA.F.EXT		
	8	38	48	III	PA.D.INT	5	33	50	II	OM.F.EXT	16	0	53	I	OM.F.INT		
	10	48	47	III	OM.D.EXT	5	49	26	I	PA.D.EXT	16	4	29	I	OM.F.EXT		
	10	57	31	III	OM.D.INT	5	53	3	I	PA.D.INT							
	11	51	34	III	PA.F.INT	6	17	58	I	OM.D.EXT	28	10	32	5	I	OC.D.EXT	
	12	0	33	III	PA.F.EXT	6	21	34	I	OM.D.INT	10	35	44	I	OC.D.INT		
	14	17	23	III	OM.F.INT	8	5	28	I	PA.F.INT	13	12	33	I	EC.F.INT		
	14	26	7	III	OM.F.EXT	8	9	6	I	PA.F.EXT	13	16	11	I	EC.F.EXT		
	17	45	24	II	OC.D.EXT	8	34	57	I	OM.F.INT	13	16	56	I	EC.F.PEN		
	17	49	13	II	OC.D.INT	8	38	34	I	OM.F.EXT							
	21	44	29	II	EC.F.INT												
	21	48	16	II	EC.F.EXT	23	3	0	28	I	OC.D.EXT	29	4	27	48	II	PA.D.EXT
	21	49	44	II	EC.F.PEN	3	4	7	I	OC.D.INT	4	31	40	II	PA.D.INT		
	22	18	25	I	PA.D.EXT	5	46	16	I	EC.F.INT	5	12	28	II	OM.D.EXT		
	22	22	2	I	PA.D.INT	5	49	54	I	EC.F.EXT	5	16	18	II	OM.D.INT		
	22	52	4	I	OM.D.EXT	5	50	39	I	EC.F.PEN	7	21	26	II	PA.F.INT		
	22	55	40	I	OM.D.INT	5	50	39	I	EC.F.PEN	7	25	18	II	PA.F.EXT		
						12	58	46	III	PA.D.EXT	7	50	54	I	PA.D.EXT		
						13	7	42	III	PA.D.INT	7	54	31	I	PA.D.INT		
						14	49	26	III	OM.D.EXT	8	7	55	II	OM.F.INT		
17	0	34	20	I	PA.F.INT	14	58	9	III	OM.D.INT	8	11	46	II	OM.F.EXT		
	0	37	57	I	PA.F.EXT	14	58	9	III	OM.D.INT	8	11	46	II	OM.F.EXT		
	1	8	57	I	OM.F.INT	16	21	54	III	PA.F.INT	8	12	25	I	OM.D.EXT		
	1	12	34	I	OM.F.EXT	16	30	50	III	PA.F.EXT	8	16	1	I	OM.D.INT		
	19	28	52	I	OC.D.EXT	18	18	49	III	OM.F.INT	10	7	6	I	PA.F.INT		
	19	32	31	I	OC.D.INT	18	27	31	III	OM.F.EXT	10	10	43	I	PA.F.EXT		
	22	19	51	I	EC.F.INT	20	34	17	II	OC.D.EXT	10	29	31	I	OM.F.INT		
	22	23	29	I	EC.F.EXT	20	38	6	II	OC.D.INT	10	33	7	I	OM.F.EXT		
	22	24	14	I	EC.F.PEN												
						24	0	19	32	II	EC.F.INT	30	5	2	43	I	OC.D.EXT
						0	19	47	I	PA.D.EXT	5	6	21	I	OC.D.INT		
18	12	9	24	II	PA.D.EXT	0	23	19	II	EC.F.EXT	7	41	23	I	EC.F.INT		
	12	13	17	II	PA.D.INT	0	23	24	I	PA.D.INT	7	45	1	I	EC.F.EXT		
	13	15	32	II	OM.D.EXT	0	24	46	II	EC.F.PEN	7	45	46	I	EC.F.PEN		
	13	19	23	II	OM.D.INT	0	24	46	II	EC.F.PEN	7	45	46	I	EC.F.PEN		
	15	2	19	II	PA.F.INT	0	46	35	I	OM.D.EXT	17	27	54	III	PA.D.EXT		
	15	6	11	II	PA.F.EXT	0	50	12	I	OM.D.INT	17	36	45	III	PA.D.INT		
	16	10	33	II	OM.F.INT	2	35	52	I	PA.F.INT	18	49	18	III	OM.D.EXT		
	16	14	24	II	OM.F.EXT	2	39	29	I	PA.F.EXT	18	57	59	III	OM.D.INT		
	16	48	43	I	PA.D.EXT	3	3	36	I	OM.F.INT	20	52	21	III	PA.F.INT		
	16	52	20	I	PA.D.INT	3	7	12	I	OM.F.EXT	21	1	14	III	PA.F.EXT		
	17	20	41	I	OM.D.EXT	21	30	59	I	OC.D.EXT	22	19	24	III	OM.F.INT		
	17	24	17	I	OM.D.INT	21	34	38	I	OC.D.INT	22	28	5	III	OM.F.EXT		
	19	4	41	I	PA.F.INT						23	23	28	II	OC.D.EXT		
	19	8	18	I	PA.F.EXT	25	0	15	1	I	EC.F.INT	23	27	16	II	OC.D.INT	
	19	37	37	I	OM.F.INT	0	18	39	I	EC.F.EXT							
	19	41	13	I	OM.F.EXT	0	19	23	I	EC.F.PEN	31	2	21	17	I	PA.D.EXT	
						15	1	16	II	PA.D.EXT	2	24	54	I	PA.D.INT		
19	13	59	25	I	OC.D.EXT	15	5	8	II	PA.D.INT	2	41	1	I	OM.D.EXT		
	14	3	4	I	OC.D.INT	15	53	12	II	OM.D.EXT	2	44	37	I	OM.D.INT		
	16	48	41	I	EC.F.INT	15	57	3	II	OM.D.INT	2	54	29	II	EC.F.INT		
	16	52	20	I	EC.F.EXT	17	54	39	II	PA.F.INT	2	58	15	II	EC.F.EXT		
	16	53	4	I	EC.F.PEN	17	58	31	II	PA.F.EXT	2	59	43	II	EC.F.PEN		
	22	39	12	III	OC.D.EXT	18	48	31	II	OM.F.INT	4	37	31	I	PA.F.INT		
	22	48	8	III	OC.D.INT	18	50	8	I	PA.D.EXT	4	41	8	I	PA.F.EXT		
						18	52	22	II	OM.F.EXT	4	58	8	I	OM.F.INT		
20	4	10	18	III	EC.F.INT	18	53	45	I	PA.D.INT	5	1	44	I	OM.F.EXT		
	4	19	3	III	EC.F.EXT	19	15	11	I	OM.D.EXT	23	33	15	I	OC.D.EXT		
	4	22	12	III	EC.F.PEN	19	18	47	I	OM.D.INT	23	36	54	I	OC.D.INT		
	7	9	50	II	OC.D.EXT	21	6	15	I	PA.F.INT							
	7	13	38	II	OC.D.INT	21	9	53	I	PA.F.EXT	32	2	10	7	I	EC.F.INT	
	11	2	2	II	EC.F.INT	21	32	14	I	OM.F.INT	2	13	45	I	EC.F.EXT		
	11	5	49	II	EC.F.EXT	21	35	50	I	OM.F.EXT	2	14	29	I	EC.F.PEN		
	11	7	17	II	EC.F.PEN						17	53	36	II	PA.D.EXT		
	11	19	5	I	PA.D.EXT	26	16	1	35	I	OC.D.EXT	17	57	28	II	PA.D.INT	
	11	22	43	I	PA.D.INT	16	5	14	I	OC.D.INT	18	30	51	II	OM.D.EXT		
	11	49	21	I	OM.D.EXT	18	43	50	I	EC.F.INT	18	34	42	II	OM.D.INT		
	11	52	57	I	OM.D.INT	18	47	28	I	EC.F.EXT	20	47	24	II	PA.F.INT		
	13	35	5	I	PA.F.INT	18	48	13	I	EC.F.PEN	20	51	16	II	PA.F.EXT		
	13	38	43	I	PA.F.EXT						20	51	39	I	PA.D.EXT		
	14	6	18	I	OM.F.INT	27	3	7	37	III	OC.D.EXT	20	55	16	I	PA.D.INT	
	14	9	54	I	OM.F.EXT	3	16	30	III	OC.D.INT	21	9	35	I	OM.D.EXT		
						8	10	34	III	EC.F.INT	21	13	12	I	OM.D.INT		
21	8	29	53	I	OC.D.EXT	8	19	17	III	EC.F.EXT	21	26	25	II	OM.F.INT		
	8	33	32	I	OC.D.INT	8	22	26	III	EC.F.PEN	21	30	16	II	OM.F.EXT		
	11	17	25	I	EC.F.INT	9	58	52	II	OC.D.EXT	23	7	56	I	PA.F.INT		
	11	21	3	I	EC.F.EXT	10	2	40	II	OC.D.INT	23	11	33	I	PA.F.EXT		
	11	21	48	I	EC.F.PEN	13	20	32	I	PA.D.EXT	23	26	44	I	OM.F.INT		
						13	24	9	I	PA.D.INT	23	30	20	I	OM.F.EXT		
22	1	35	41	II	PA.D.EXT	13	37	1	II	EC.F.INT							

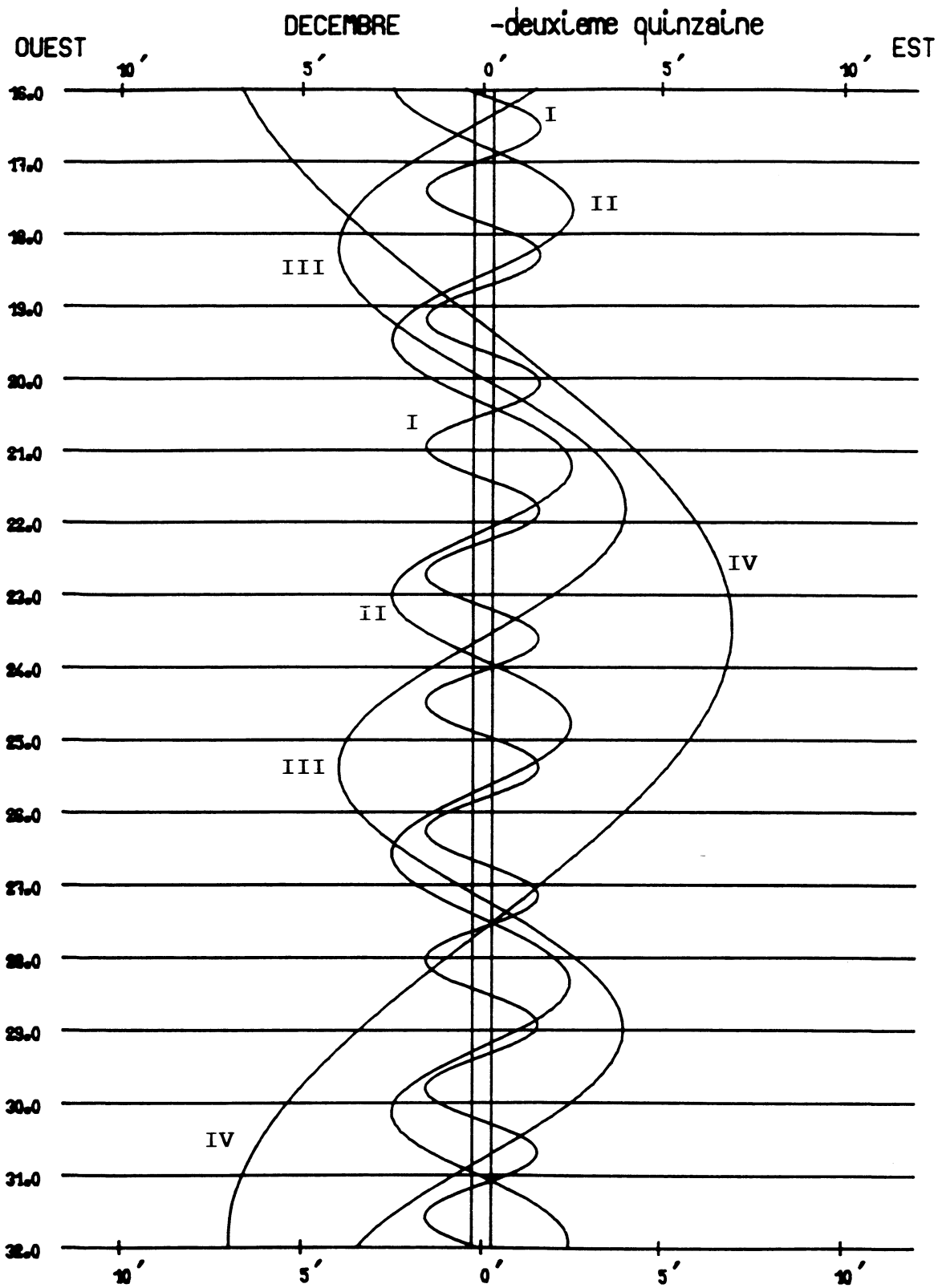

Dans le sens OUEST-EST, les satellites passent au-delà de Jupiter

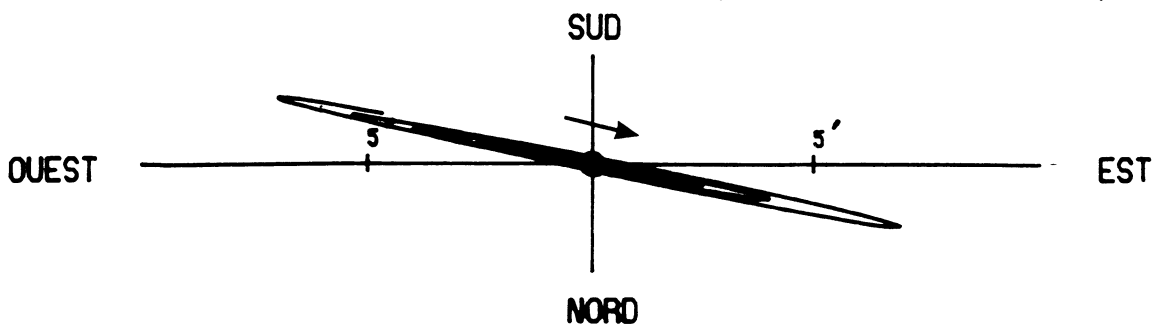

ORBITES APPARENTES

PHÉNOMÈNES POUR 1997

PHENOMENA FOR 1997

Pour l'année 1997, les phénomènes sont donnés par l'intermédiaire de coefficients d'un polynôme. On a ainsi une représentation sous une forme très condensée. La précision est cependant moins bonne que celle des prédictions des phénomènes pour 1996. Cette précision et la méthode pour déterminer les phénomènes sont données ci-après.

UTILISATION DES COEFFICIENTS

Soit P la période synodique moyenne d'un satellite ; la date approchée T₁ du phénomène proche de la date T est donnée par la relation :

$$(1) \quad T_1 = K P + \tau/24 + T_0$$

où K représente la partie entière de la quantité (T - T₀)/P et où τ est donné, sur l'intervalle T₀ , T₀ + DT par un polynôme de la forme :

$$(2) \quad \tau = C_0 + C_1 x + C_2 x^2 + \dots + C_n x^n$$

avec

$$(3) \quad x = [2(T - T_0) / DT] - 1$$

T₁ ayant été obtenu par la relation (1), on peut réitérer le calcul en substituant T₁ à T dans la formule (3) pour obtenir une date T₂ plus proche du phénomène recherché que T₁. La précision de ce type de prédiction est meilleure que 60 secondes de temps.

Les tables donnent les coefficients C_i de la formule (2), numérotés de C₀ à C₁₁ pour les quatre satellites et pour les phénomènes:

- débuts et fins des éclipses des satellites par Jupiter (notés EC.D et EC.F),
- débuts et fins des occultations des satellites par Jupiter (notés OC.D et OC.F),
- débuts et fins des passages de l'ombre des satellites sur le disque de Jupiter (OM.D et OM.F),
- débuts et fins des passages des satellites devant la planète (PA.D et PA.F).

For 1997, the phenomena are given using polynomial coefficients. So, we have a compact representation. However, the accuracy is less than the one from the data given for 1996. This accuracy and the method of calculation of the phenomena are given here after.

USE OF THE COEFFICIENTS

Let P be the mean synodique period of a satellite ; the approximate date T₁ of a phenomenon close to a date T is given by :

$$(1) \quad T_1 = K P + \tau/24 + T_0$$

where K is the integer part of (T - T₀)/P and where τ is given on the interval (T₀ , T₀ + DT) by a polynomial :

$$(2) \quad \tau = C_0 + C_1 x + C_2 x^2 + \dots + C_n x^n$$

with

$$(3) \quad x = [2(T - T_0) / DT] - 1$$

The value T₁ deduced from equation (1) is then substituted in place of T in equation (3). The new iteration yields a date T₂ closer to the date of the phenomenon than T₁. The precision of this type of prediction is better than 60 seconds of time.

The tables give the coefficients C_i in formula (2) numbered from C₀ to C₁₁ for the four satellites and for the following phenomena :

- disappearance and reappearance of the satellites eclipsed by Jupiter (denoted respectively by EC.D and EC.F),
- disappearance and reappearance of the satellites occulted by Jupiter (denoted OC.D and OC.F),
- ingress and egress of the transits of the satellites shadow across the disc of Jupiter (OM.D and OM.F),
- ingress and egress of the satellites transits across the planet (PA.D and PA.F).

EXEMPLE D'UTILISATION

Déterminons les dates des phénomènes du satellite I (Io) au voisinage du 30 juin 1997.

Voyons tout d'abord le calcul pour le début d'éclipse pour lequel les tables donnent :

$$T_0 = 0 ; P = 1,7698605 ; DT = 366$$

Du 0 janvier au 30 juin 1997, 181 jours se sont écoulés, on a donc :

$$T = 181 \text{ et la formule (3) donne alors :}$$

$$x = 2(181 - 0)/366 - 1 = - 0.01092896$$

La formule (2) donne ensuite :

EXAMPLE

Let us find the dates of the phenomena of satellite I (Io) which take place near the 30th of June 1997

Let us start with the computation of the disappearance for the occultation of the satellite for which the tables gives :

$$T_0 = 0 ; P = 1.7698605 ; DT = 366$$

Between January 0 to June the 30th 1997, 181 days have elapsed :

$$T = 181 \text{ and formula (3) gives :}$$

$$x = 2(181 - 0)/366 - 1 = - 0.01092896$$

Formula (2) then gives :

$$\begin{aligned} \tau = & 23.781866 - 0.267866 x + 0.372963 x^2 + 0.632643 x^3 \\ & - 0.329428 x^4 - 0.633849 x^5 + 0.226566 x^6 + 0.539690 x^7 \\ & - 0.153964 x^8 - 0.318481 x^9 + 0.053342 x^{10} + 0.089472 x^{11} \end{aligned}$$

d'où : $\tau = 23.784837$

On a d'autre part :

$$K = \text{partie entière de } (181 - 0)/1,7698605$$

$$= 102$$

La formule (1) donne alors :

$$T_1 = 102 \times 1,7698605 + 23.784837/24 + 0$$

$T_1 = 181$ jours depuis le 0 janvier (début de l'intervalle pour les éclipses) soit EC.D le 30 juin 1997 à 12h 24m 12s TT. Le calcul réitéré donne $T_2 = 81.516774$ jours soit le 30 juin 1997 à 12h 24m 08s TT.

On trouverait de même pour les autres phénomènes :

OM.D le 29 juin à 15h 05m 10s
 PA.D le 29 juin à 16h 00m 35s
 OM.F le 29 juin à 17h 22m 44s
 PA.F le 29 juin à 18h 18m 07s
 EC.F le 30 juin à 14h 41m 49s
 OC.D le 30 juin à 13h 18m 45s
 OC.F le 30 juin à 15h 36m 17s

therefore $\tau = 23.784837$

On the other hand :

$$K = \text{integer part of } (181 - 0)/1.7698605$$

$$= 102$$

Formula (1) then gives :

$$T_1 = 102 \times 1.7698605 + 23.784837/24 + 0$$

$T_1 = 181$ days from January 0 (beginning of the interval for the occultations) that is June the 30th 1997 at 12h 24m 12s TT. Another iterations gives $T_2 = 81.516774$ days that is June the 30th 1997 at 12h 24m 08s TT.

One would find as well for the other phenomena :

*OM.D June the 29th at 15h 05m 10s
 PA.D June the 29th at 16h 00m 35s
 OM.F June the 29th at 17h 22m 44s
 PA.F June the 29th at 18h 18m 07s
 EC.F June the 30th at 14h 41m 49s
 OC.D June the 30th at 13h 18m 45s
 OC.F June the 30th at 15h 36m 17s*

**CONDITIONS D'EXISTENCE DES
PHENOMENES**

Le recouvrement des cônes d'ombre et de visibilité rend inexistants certains phénomènes. Ainsi avant (ou après) l'opposition de Jupiter, les fins (respectivement débuts) d'éclipse et les débuts (respectivement fins) d'occultations sont inobservables. Ceci ne pouvant être pris en compte dans la représentation, il est nécessaire que l'utilisateur vérifie les conditions d'existence pour les éclipses et les occultations en calculant les quatre phases EC.D, EC.F, OC.D et OC.F. Ainsi, dans l'exemple précédent, on a dans l'ordre chronologique :

EC.D le 30 juin à 12h 24m 08s observable

OC.D le 30 juin à 13h 18m 45s inobservable car déjà éclipsé

EC.F le 30 juin à 14h 41m 49s inobservable car occulté

OC.F le 30 juin à 15h 36m 17s observable.

D'autre part, les caractéristiques de l'orbite du satellite IV (Callisto) font qu'il n'existe pas toujours de phénomènes. Les coefficients relatifs à ce satellite ne sont donc donnés que sur l'intervalle où ils existent.

**CONDITIONS FOR THE EXISTENCE
OF THE PHENOMENA**

As the visibility and shadow cones may sometimes overlap, some of the computed phenomena may not exist. Thus, before (or after) the opposition of Jupiter, the reappearances (respectively the disappearances) for the eclipses, and the disappearances (respectively reappearances) for the occultations are not observable. This could not be taken into account in the representation ; so the user will have to check the existence conditions of the eclipses and occultations by computing the four steps EC.D, EC.F, OC.D and OC.F. For instance, in the example above one has, in chronological order :

EC.D June 30th at 12h 24m 08s observable

OC.D June 30th at 13h 18m 45s unobservable as eclipsed

EC.F June 30th at 14h 41m 49s unobservable as occulted

OC.F June 30th at 15h 36m 17s observable.

Moreover, the orbit of satellite IV (Callisto) is such that phenomena are not always present. The coefficients for this satellite are given on the interval for which they exist.

1997- COEFFICIENTS DES PHÉNOMÈNES DES SATELLITES GALILÉENS DE JUPITER

SATELLITE 1 P= 1.7698605jours TO= 0 DT= 366jours							
	EC.D		EC.F		OM.D		OM.F
0	23.781866	0	26.076202	0	2.465344	0	4.759647
1	-0.267866	1	-0.281592	1	-0.161148	1	-0.062269
2	0.372963	2	0.383127	2	0.718841	2	0.655306
3	0.632643	3	0.652697	3	0.853914	3	0.268469
4	-0.329428	4	-0.341318	4	-0.768551	4	-0.756944
5	-0.633849	5	-0.625616	5	-1.838177	5	-0.389704
6	0.226566	6	0.237371	6	0.760936	6	0.979970
7	0.539690	7	0.497163	7	2.597439	7	0.709019
8	-0.153964	8	-0.168913	8	-0.548295	8	-0.852922
9	-0.318481	9	-0.272197	9	-1.994899	9	-0.703180
10	0.053342	10	0.060371	10	0.166158	10	0.286212
11	0.089472	11	0.072455	11	0.616526	11	0.254954
	OC.D		OC.F		PA.D		PA.F
0	24.665839	0	26.959663	0	3.347968	0	5.643055
1	-3.621997	1	-3.635755	1	-3.459889	1	-3.373686
2	-5.067436	2	-5.037884	2	-4.948789	2	-4.991973
3	5.525138	3	5.519854	3	5.440012	3	4.902751
4	9.893665	4	9.807805	4	10.537094	4	10.482750
5	-1.517197	5	-1.412524	5	-1.567870	5	-0.184960
6	-12.136335	6	-11.990538	6	-13.550703	6	-13.225712
7	-2.786542	7	-2.970311	7	-2.982662	7	-4.807964
8	8.377197	8	8.237190	8	9.588467	8	9.193930
9	3.284321	9	3.443672	9	3.661736	9	4.918358
10	-2.397879	10	-2.346185	10	-2.788525	10	-2.638445
11	-1.115417	11	-1.170919	11	-1.289121	11	-1.643385

TO = 0 correspond au 0 janvier 1997 à 0h soit la date julienne 2450448.5

SATELLITE 2 P= 3.5540942jours TO= -1 DT= 367jours							
	EC.D		EC.F		OM.D		OM.F
0	23.681503	0	26.592659	0	66.758726	0	69.618792
1	0.291056	1	0.329365	1	-0.582242	1	-0.562047
2	1.205005	2	1.100483	2	-0.105286	2	-0.119518
3	0.240836	3	0.158530	3	1.479405	3	0.906705
4	-0.643529	4	-0.509421	4	-0.562142	4	-0.547373
5	-1.115689	5	-1.019744	5	-1.677338	5	-0.285720
6	0.060677	6	-0.203376	6	1.613367	6	1.791259
7	1.926139	7	1.773240	7	1.072744	7	-0.431508
8	-0.033818	8	0.249471	8	-1.761891	8	-2.067230
9	-1.731835	9	-1.577453	9	0.059463	9	0.870595
10	0.054916	10	-0.055653	10	0.695222	10	0.830221
11	0.616151	11	0.555862	11	-0.268950	11	-0.446148
	OC.D		OC.F		PA.D		PA.F
0	25.514234	0	28.413153	0	68.534463	0	71.376717
1	-6.433381	1	-6.411058	1	-7.192418	1	-7.155209
2	-10.545330	2	-10.509014	2	-11.034505	2	-10.905147
3	9.831784	3	9.901023	3	10.806354	3	10.153870
4	21.935654	4	21.741534	4	20.403099	4	20.052393
5	-1.945862	5	-2.179538	5	-1.996764	5	-0.272354
6	-27.026044	6	-26.842868	6	-24.598645	6	-23.877473
7	-6.277954	7	-5.982637	7	-8.097496	7	-10.236296
8	18.351625	8	18.290366	8	16.773964	8	16.045745
9	6.636023	9	6.455358	9	9.437716	9	10.833934
10	-5.153981	10	-5.156298	10	-4.699511	10	-4.437348
11	-2.126686	11	-2.086080	11	-3.403563	11	-3.784071

TO = 0 correspond au 0 janvier 1997 à 0h soit la date julienne 2450448.5

1997- COEFFICIENTS DES PHÉNOMÈNES DES SATELLITES GALILÉENS DE JUPITER

SATELLITE 3 P= 7.1663872jours TO= -1 DT= 367jours							
EC.D		EC.F		OM.D		OM.F	
0	104.759376	0	108.393514	0	18.828902	0	22.447466
1	-0.021191	1	0.065072	1	0.013876	1	0.225186
2	0.655512	2	0.551384	2	0.663703	2	0.530310
3	0.520693	3	0.516311	3	1.061262	3	0.165488
4	-1.143852	4	-1.073686	4	0.228499	4	0.118121
5	-0.232211	5	-0.204231	5	-2.001034	5	0.232407
6	2.493571	6	2.327205	6	-2.242414	6	-1.642338
7	-0.267889	7	-0.330282	7	2.117807	7	-0.737621
8	-2.828296	8	-2.660312	8	3.088492	8	2.359533
9	0.380704	9	0.427028	9	-1.007061	9	0.910130
10	1.142761	10	1.081060	10	-1.338117	10	-1.058169
11	-0.119553	11	-0.128473	11	0.119958	11	-0.412681
OC.D		OC.F		PA.D		PA.F	
0	108.374636	0	112.030386	0	22.447966	0	26.085565
1	-13.470261	1	-13.470606	1	-13.396623	1	-13.275885
2	-21.942057	2	-21.969710	2	-22.181696	2	-22.234660
3	19.949820	3	20.064492	3	19.973316	3	19.233204
4	41.599492	4	41.212241	4	44.247768	4	43.743270
5	-3.045227	5	-2.863303	5	-2.396242	5	-0.128929
6	-48.998893	6	-48.364260	6	-56.200021	6	-54.990163
7	-14.635720	7	-14.931641	7	-17.159321	7	-20.060093
8	32.479795	8	31.980513	8	40.471684	8	39.278894
9	15.504445	9	15.654317	9	18.616238	9	20.496856
10	-8.948845	10	-8.796636	10	-12.073072	10	-11.654050
11	-5.128349	11	-5.152162	11	-6.414792	11	-6.922636

TO = 0 correspond au 0 janvier 1997 à 0h soit la date julienne 2450448.5

SATELLITE 4 P= 16.7535520jours TO= 0 DT= 366jours							
EC.D		EC.F		OM.D		OM.F	
0	123.724706	0	128.553975	0	323.627941	0	328.469370
1	0.305937	1	0.416619	1	0.561316	1	0.841261
2	0.860425	2	0.471875	2	1.004884	2	0.540941
3	0.560935	3	0.562755	3	1.356389	3	0.214498
4	-0.252329	4	-0.235028	4	-1.106650	4	-1.135118
5	-0.881340	5	-0.919389	5	-2.872799	5	-0.054167
6	-0.231391	6	-0.303540	6	1.875415	6	2.394324
7	1.296757	7	1.395614	7	3.966467	7	0.471114
8	0.406874	8	0.494604	8	-1.773772	8	-2.485279
9	-1.147773	9	-1.255293	9	-3.013882	9	-0.786026
10	-0.177631	10	-0.214037	10	0.639501	10	0.925143
11	0.406250	11	0.447851	11	0.939311	11	0.362688
OC.D		OC.F		PA.D		PA.F	
0	132.051642	0	136.850338	0	332.137401	0	336.947750
1	-31.026116	1	-31.097545	1	-31.403092	1	-31.350776
2	-51.217501	2	-50.725775	2	-52.503789	2	-52.067304
3	45.824792	3	46.202951	3	47.360678	3	46.867925
4	98.557049	4	96.166164	4	101.443174	4	98.919619
5	-7.623823	5	-6.858505	5	-8.384201	5	-6.093866
6	-119.588867	6	-116.445991	6	-123.434720	6	-119.437510
7	-32.357800	7	-34.639557	7	-34.086527	7	-36.616352
8	82.404347	8	80.289555	8	85.093703	8	81.779667
9	34.494758	9	37.130823	9	37.407749	9	38.668645
10	-23.635498	10	-23.109065	10	-24.366647	10	-23.303577
11	-11.402478	11	-12.525617	11	-12.673664	11	-12.930879

TO = 0 correspond au 0 janvier 1997 à 0h soit la date julienne 2450448.5

